

Series 802/803 Prime Focus Parabolic Antennas

Features

- ▶ High Directivity and Gain
- ▶ Wide Range of Available Beamwidths and Reflector Sizes
- ▶ Stable Electrical Operation
- ▶ Excellent Sidelobe Performance
- ▶ Rugged Mechanical Design

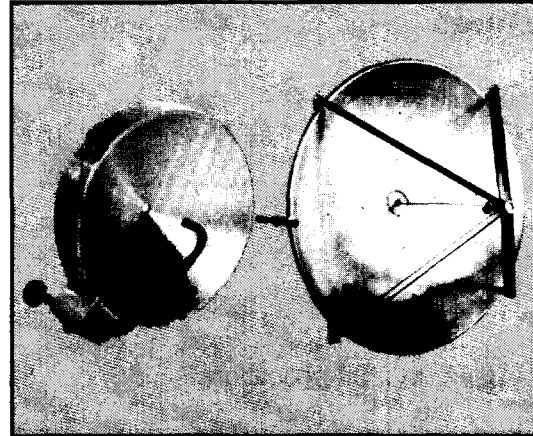

Description

Each antenna consists of a parabolic reflector, a linearly-polarized primary feed, and a feed support assembly of four low-profile aluminum spars that are attached to the rim of the reflector in order to position the feed accurately. Tapped holes are provided on each antenna for mounting.

The Series 802 antennas feature a precision-machined aluminum casting as a main reflector which provides excellent performance at millimeter wave frequencies between 26.5 GHz and 220 GHz. This rugged design is recommended for frequencies where low surface tolerances (typically 0.001 inch RMS) are critical for electrical performance. The rugged characteristics of the Series 802 antennas makes them well-suited for applications where heavy duty operation is necessary. Alpha can also supply the lightweight series 804 antennas with precision machined aluminum reflectors for 3 inch to 24 inch diameters. This version of lightweight antennas also maintains the low surface tolerances (typically 0.001 inch RMS). Alpha can also

supply the lightweight series 805 with precision graphite microwave reflectors for 12 inch to 72 inch diameters.

For applications that require larger diameters, the Series 803 antennas feature metallized plastic reflectors and cover a frequency range from 10.0 GHz to 100 GHz. They are available in diameters from 18 inches to 120 inches with low surface tolerances (typically 0.0025 inch RMS).

Band Letter	Series	Diameter
A through W	802,804	3
K through W	802,804	6
Ku through W	802,804	12
Ku through W	802,804	18
Ku through W	802,804	24
Ku through W	802,805	18
Ku through W	802,805	24
Ku through W	802,805	36
Ku through W	802,805	48

Ordering Information

The center frequency should be specified when ordering these antennas. Bandwidths are typically $\pm 5\%$. Sidelobes are nominally -20dB . Boresight telescopes and boresighting are recommended and are available on request.

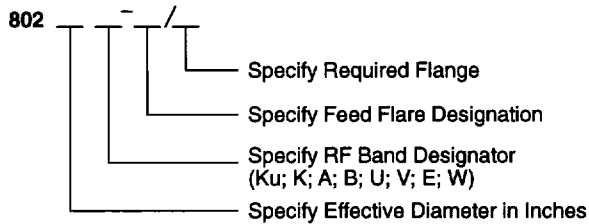

For example: Model number 802006W-2/387 is a Series 802 antenna with a 6 inch effective aperture operating in W-band at 94 GHz with a 387 type flange.

Please be sure to specify center frequency. Each antenna is tested at the Customer's center frequency up to 100 GHz and optimum focal adjustments are made. Test data will include principal E and H plane radiation patterns at the designated frequency. Special test arrangements may be made for applications above 100 GHz depending on the availability of test sources.

Outline Drawing

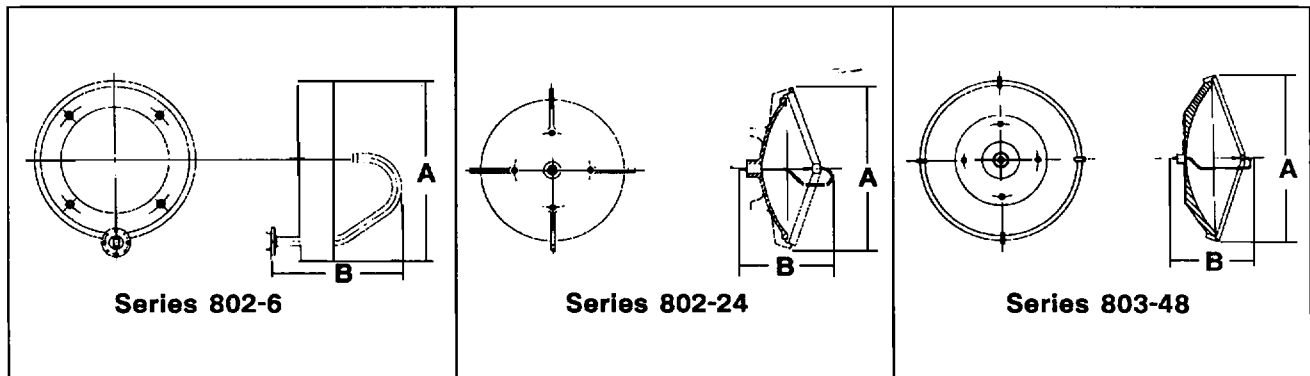

Effective Diameter (inches)	Series 802				Series 803			
	A		B		A		B	
	in	mm	in	mm	in	mm	in	mm
3	3.4	86	3.7	94	--	--	--	--
6	7.3	185	5.1	129	--	--	--	--
12	15.0	381	10.5	266	--	--	--	--
18	22.0	558	11.0	279	22.0	558	11.8	300
24	28.2	716	15.7	399	27.4	696	15.0	381
36	--	--	--	--	39.2	996	20.3	515
48	--	--	--	--	54.0	1372	23.5	597

Typical Antenna Patterns for 802 Series Antenna

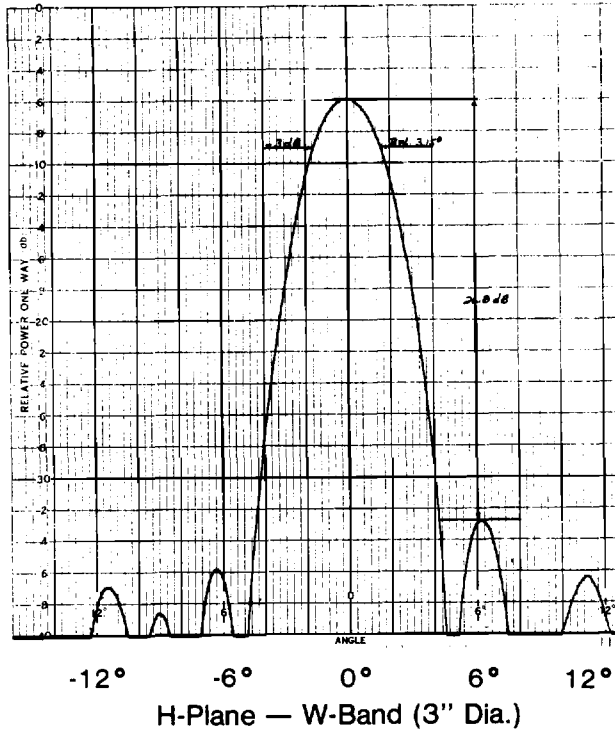
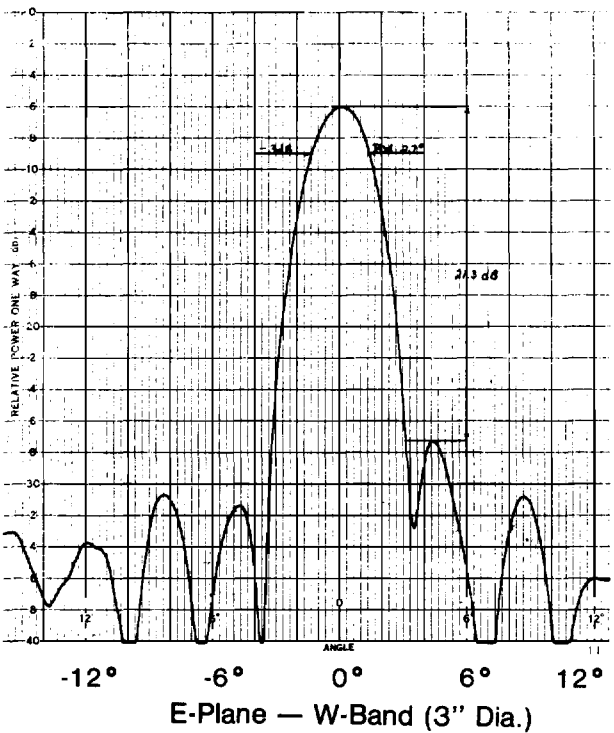
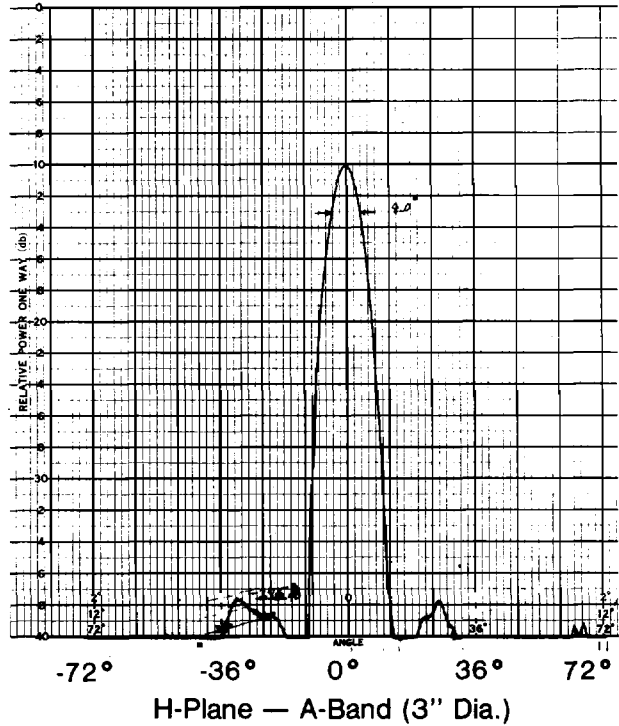
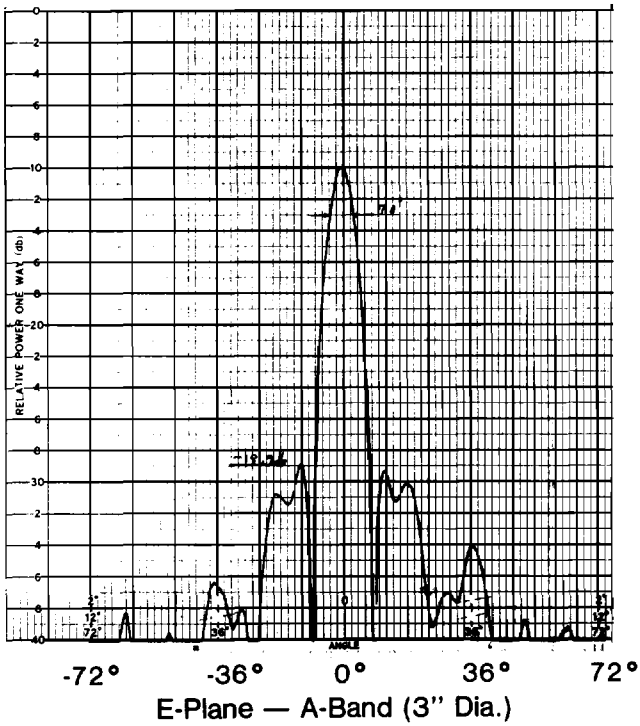

Typical Antenna Patterns for 802 Series Antenna

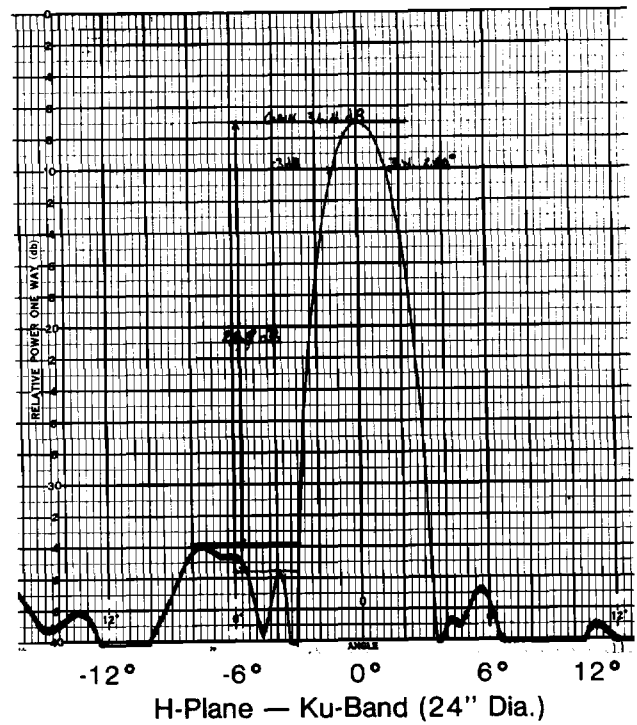
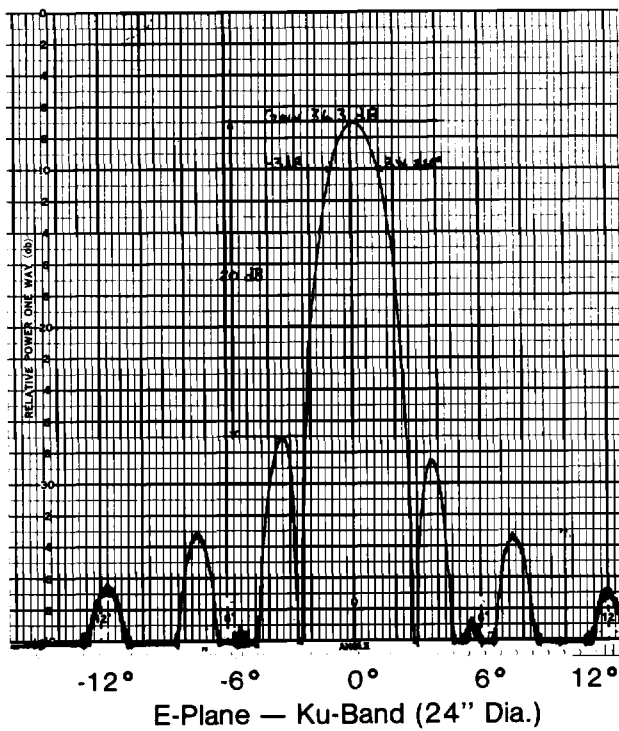
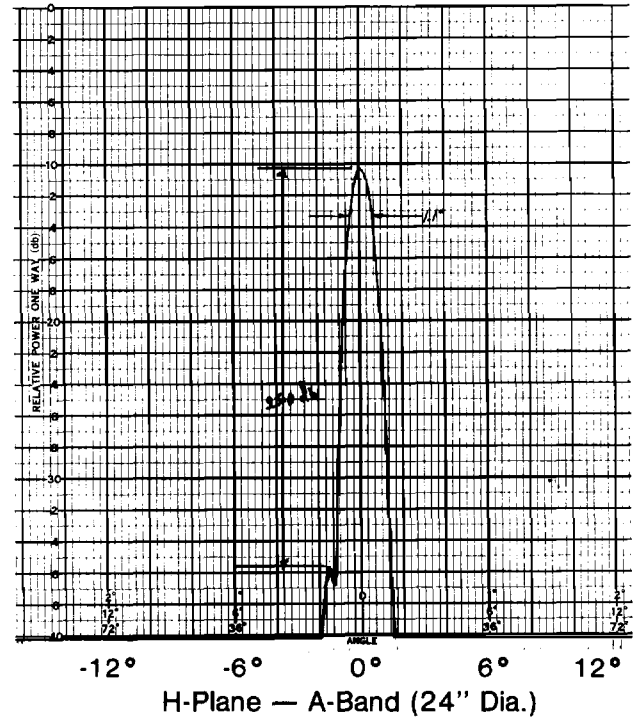
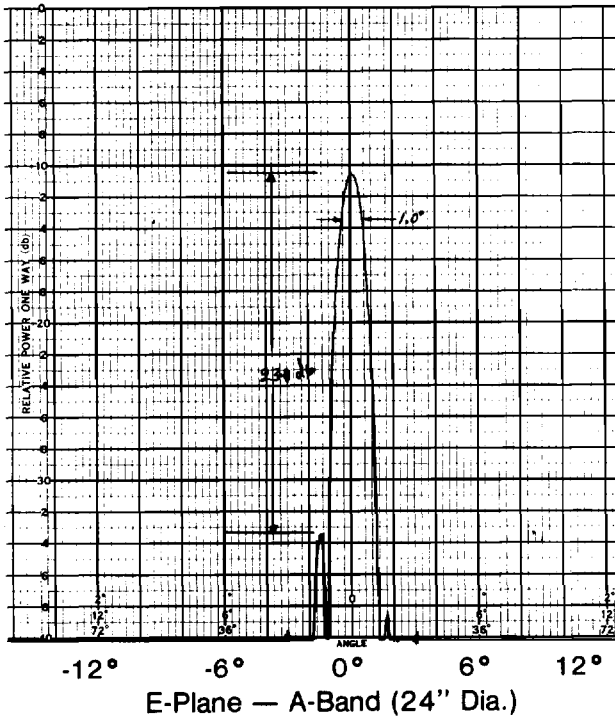

Typical Antenna Patterns for 803 Series Antenna

