





SMT POWER INDUCTORS

Unshielded Drum Core – PG0016NL Series



-  **Current Rating:** up to 8.5A
-  **Inductance Range:** 0.33μH to 220μH
-  **Height:** 4.85 mm Max
-  **Footprint:** 6.0mm x 5.4mm MAX

Electrical Specifications @ 25°C — Operating Temperature -40°C to +130°C⁶

Part ⁵ Number	Inductance @I _{rated} ¹ (μH TYP)	I _{rated} ² (A)	DCR (mΩ)	Inductance @ 0A _{dc} (μH ± 15%)	Saturation Current ³ I _{sat} (A TYP)	Heating Current ⁴ I _{dc} (A TYP)
PG0016.331NL	0.29	8.5	4.3	0.33	13	8.5
PG0016.561NL	0.48	6.6	6.5	0.56	10	6.6
PG0016.681NL	0.68	6.0	7.0	0.68	8.0	6.0
PG0016.821NL	0.71	6.0	11	0.82	7.8	6.0
PG0016.102NL	1.0	4.5	13	1.0	6.8	4.5
PG0016.152NL	1.3	4.0	16	1.5	6.1	4.0
PG0016.222NL	2.1	3.2	23	2.2	5.0	3.2
PG0016.272NL	2.7	2.9	25	2.7	4.2	2.9
PG0016.332NL	3.1	2.6	30	3.3	4.0	2.6
PG0016.472NL	4.2	2.3	34	4.7	3.3	2.3
PG0016.682NL	6.1	1.8	55	6.8	2.9	1.8
PG0016.822NL	7.4	1.7	60	8.2	2.6	1.7
PG0016.103NL	10	1.5	80	10	2.3	1.5
PG0016.123NL	12	1.4	120	12	2.1	1.4
PG0016.153NL	14	1.3	140	15	1.8	1.3
PG0016.183NL	18	1.2	150	18	1.6	1.2
PG0016.223NL	21	1.1	180	22	1.6	1.1
PG0016.273NL	27	0.97	200	27	1.4	0.97
PG0016.333NL	33	0.88	230	33	1.3	0.88
PG0016.393NL	39	0.80	320	39	1.1	0.80
PG0016.473NL	46	0.72	370	47	1.0	0.72
PG0016.563NL	56	0.68	420	56	0.95	0.68
PG0016.683NL	68	0.61	530	68	0.80	0.61
PG0016.823NL	82	0.58	600	82	0.70	0.58
PG0016.104NL	100	0.52	840	100	0.70	0.52
PG0016.124NL	120	0.48	930	120	0.60	0.48
PG0016.154NL	150	0.40	1250	150	0.55	0.40
PG0016.184NL	180	0.38	1400	180	0.50	0.38
PG0016.224NL	217	0.35	1600	220	0.50	0.35

Mechanical

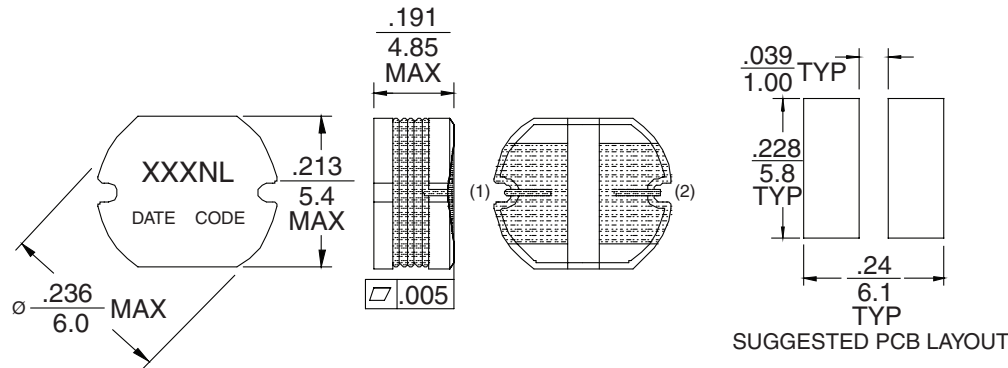

Schematic

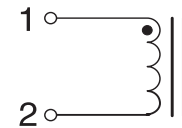

Weight 0.46 grams
Tape & Reel 1400pcs/reel

Dimensions: $\frac{\text{Inches}}{\text{mm}}$
Unless otherwise specified,
all tolerances are $\pm \frac{.004}{0,10}$

SMT POWER INDUCTORS

Unshielded Drum Core – PG0016NL Series



NOTES:

1. Inductance at Irated is a typical inductance value for the component taken at rated current.
2. The rated current listed is the lower of the saturation current @ 25°C or the heating current.
3. The saturation current, Isat, is the current at which the component inductance drops by 10% (typ.) at an ambient temperature of 25°C. This current is determined by placing the component in the specified ambient environment and applying a short duration pulse current (to eliminate self-heating effects) to the component.
4. The heating current, IDC, is the DC current required to raise the component temperature by approximately 40°C. The heating current is determined by mounting the component on a typical PCB and applying current for 30 minutes.
5. Optional Tape & Reel packaging can be ordered by adding a "T" suffix to the part number (i.e. PG0016.331NL becomes PG0016.331NLT). Pulse complies to industry standard tape and reel specification EIA481.
6. The temperature of the component (ambient plus temperature rise) must be within the stated operating temperature range.

Typical Inductance vs. Current Characteristics

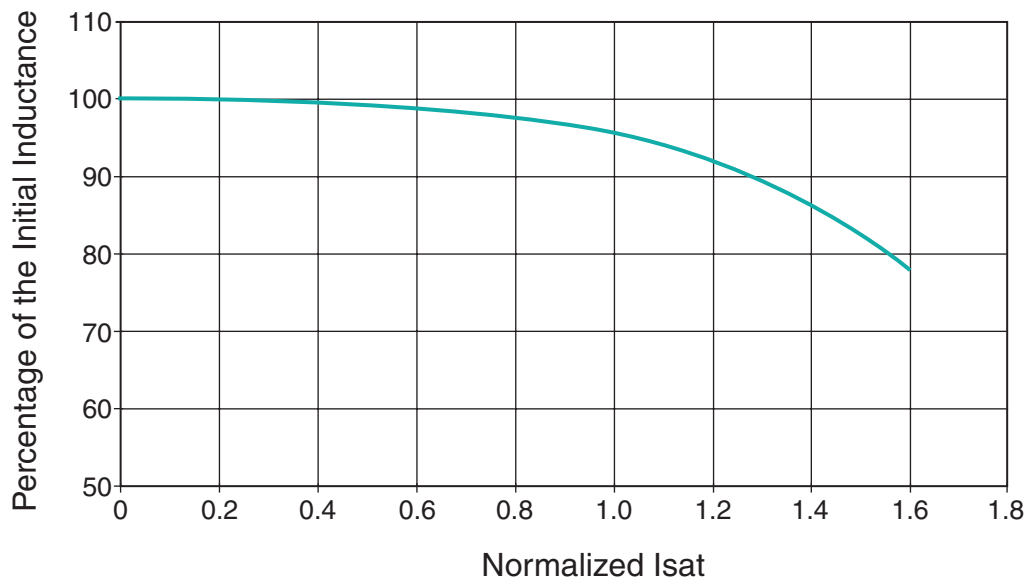

For More Information:

Pulse Worldwide Headquarters	Pulse Europe	Pulse China Headquarters	Pulse North China	Pulse South Asia	Pulse North Asia
12220 World Trade Dr. San Diego, CA 92128 U.S.A.	Einsteinstrasse 1 D-71083 Herrenberg Germany	B402, Shenzhen Academy of Aerospace Technology Bldg. 10th Kejinan Rd. High-Tech Zone Nanshan District Shenzen, PR China 518057	Room 1503 XinYin Building No. 888 YiShan Rd. Shanghai 200233 China	135 Joo Seng Rd. #03-02 PM Industrial Bldg. Singapore 368363	No. 26, Kao Ching Rd. Yang Mei Chen Taoyuan Hsien Taiwan R. O. C.
www.pulseeng.com Tel: 858 674 8100 Fax: 858 674 8262	Tel: 49 7032 7806 0 Fax: 49 7032 7806 135	TEL: 86 755 33966678 FAX: 86 755 33966700	Tel: 86 21 54643211/2 Fax: 86 21 54643210	TEL: 65 6287 8998 FAX: 65 6280 0080	Tel: 886 3 4643715 Fax: 886 3 4641911

Performance warranty of products offered on this data sheet is limited to the parameters specified. Data is subject to change without notice. Other brand and product names mentioned herein may be trademarks or registered trademarks of their respective owners.
© Copyright, 2009. Pulse Engineering, Inc. All rights reserved.