













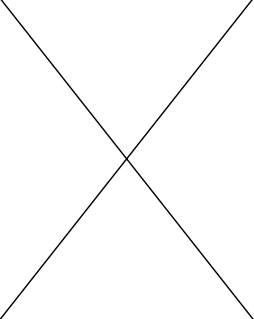







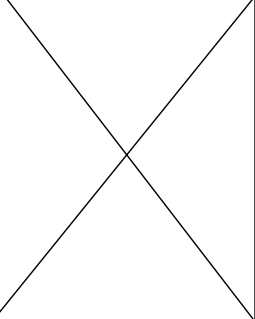



















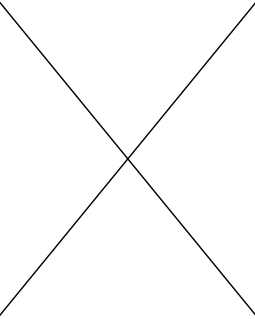







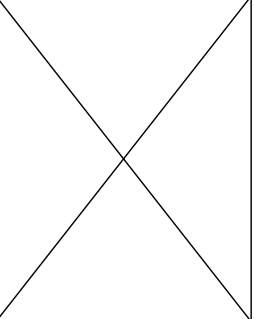



















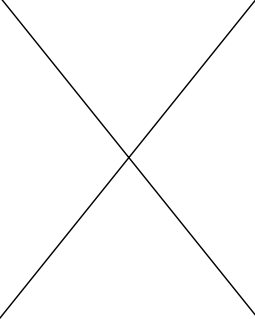







STRAIGHT D-SUB BOARD MOUNT OPTIONS

TERMINATION TYPE

		STANDARD		S OPTION		E OPTION	
		P.C. PINS		SOLDER CUP		EXTENDED P.C. PINS	
H OPTION							
HOLE							
K OPTION							
5.8mm RIVET ATTACHED IN FRONT							
STANDARD							
2.5mm HEX RIVET							
D OPTION							
5.8mm RIVET ATTACHED IN BACK							
A OPTION							
3.8mm RIVET ATTACHED IN BACK							
G OPTION							
5.8mm BOARD LOCK							
U OPTION							
11.9mm BOARD LOCK							
R OPTION ASSEMBLED							
4-40 THREADED RIVET & JACK SCREW							
P OPTION UNASSEMBLED							

MATING FACE OPTIONS

6

5

4

3

2

1

MATERIAL AND FINISH

Insulator: PBT & glass filled reinforced, UL 94V-0 rated.
Shell: Steel, Tin plated.
Pin contact: Brass, Gold Plating over Nickel in contact area, Gold flash on tails.

ELECTRICAL SPECIFICATIONS:

Rated current: 3A
Rated voltage: 250VDC
Insulation resistance: 3000 Mohm min @ 500VDC
Dielectric withstanding voltage: 1000VAC / 1 MIN.
Contact resistance: 15 mohm

ENVIRONMENTAL:

Operating temperature: -55°C to +105°C

NOTES:

Replace first XX in P/N with number of positions.

POSITION	A	B	C
09	16.3	25.0	30.8
15	24.6	33.3	39.2
25	38.3	47.1	53.1
37	54.8	63.5	69.4

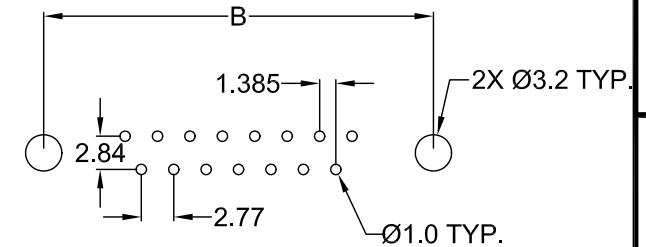
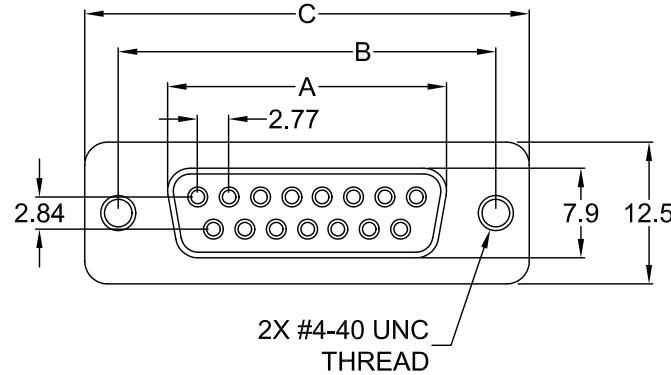

RECOMMENDED PCB LAYOUT (TOP VIEW)

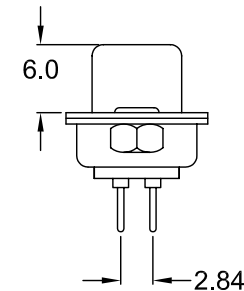
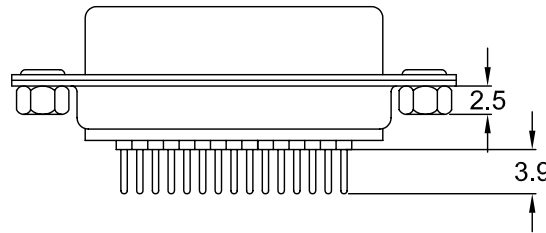

-X-XX: SEE ORDERING CODE FOR OPTIONS

REVISIONS	CHNG	CHK	APPR
	CHANGE		
	REV	DATE	

TOLERANCE UNLESS OTHERWISE SPECIFIED	
X	± 1
X.X	± 0.4
X.XX	± 0.20
DRAWN BY	DF
CHECK BY	
APPR BY	
DATE:	2/9/06
DATE:	
DATE:	

Power Dynamics, Inc.
Phone: 973 560-0019 Whippany, New Jersey Fax: 973 560-0076

PART: STRAIGHT FEMALE D-SUB
PC PINS

PART #: **PDI-XXRS-X-XX**

SCALE: NTS

ALL DIMENSIONS FOR REFERENCE ONLY
DIMENSIONS ARE IN MILLIMETERS

SHEET 1 of 1

REV:

6

5

4

3

2

1

6

5

4

3

2

1

MATERIAL AND FINISH:

Insulator: PBT and Glass-fiber reinforced, UL-94V-0 rated.
Shell: Steel, Tin plated.
Contact: Brass, Gold plated over Nickel.

ELECTRICAL SPECIFICATIONS:

Rated current: 3A
Rated voltage: 250VDC
Insulation resistance: 3000 Mohm min. at 500VDC
Dielectric withstanding voltage: 1000VAC for one minute
Contact resistance: 15 mohm

ENVIRONMENTAL:

Operating temperature: -55°C ~ +105°C

NOTES:

Replace first XX in P/N with number of positions.

POSITION	A	B	C
09	16.92	25.0	30.8
15	25.25	33.3	39.2
25	38.96	47.1	53.1
37	55.42	63.5	69.4

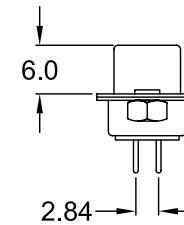
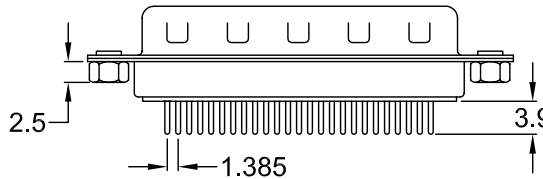
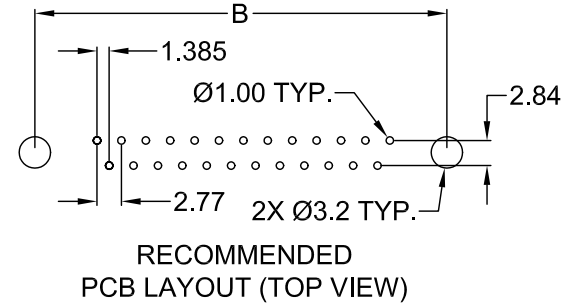
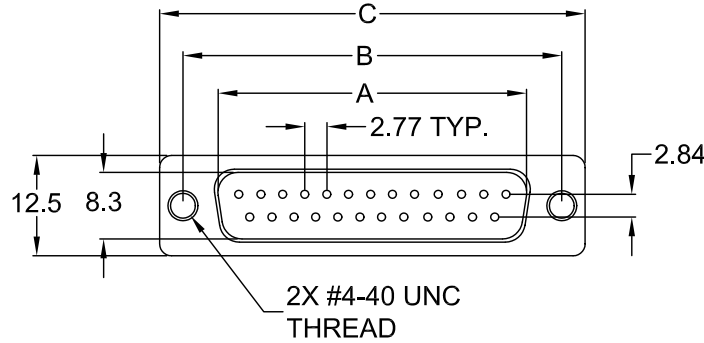

-X-XX: SEE ORDERING CODE FOR OPTIONS

REVISIONS	CHNG	CHK	APPR
	CHANGE		
	REV	DATE	

TOLERANCE UNLESS OTHERWISE SPECIFIED			
X	± 1		
X.X	± 0.4		
X.XX	± 0.20		
DRAWN BY	DF	DATE:	2/9/06
CHECK BY		DATE:	
APPR BY		DATE:	

Power Dynamics, Inc.
Phone: 973 560-0019 Whippany, New Jersey Fax: 973 560-0076

PART: STRAIGHT MALE D-SUB
PC PINS

PART #: PDI-XXSS-X-XX		SHEET 1 of 1
SIZE: A	ALL DIMENSIONS FOR REFERENCE ONLY DIMENSIONS ARE IN MILLIMETERS	REV:
SCALE: NTS		

6

5

4

3

2

1

6

5

4

3

2

1

MATERIAL AND FINISH

Shell: steel, tin plated.

Pin contact: Brass, Gold Plating over Nickel in contact area, tin on tails.

Insulator: PBT & glass filled reinforced, UL 94V-0 rated.

ELECTRICAL SPECIFICATIONS:

Rated current: 3A

Rated voltage: 250VDC

Insulation resistance: 3000 Mohm min @ 500VDC

Dielectric withstanding voltage: 1000VAC / 1 MIN.

Contact resistance: 15 mohm

ENVIRONMENTAL:

Operating temperature: -55°C to +105°C

NOTES:

1. Replace first XX in P/N with number of positions.

POSITION	A	B	C
09	16.3	25.0	30.8
15	24.6	33.3	39.2
25	38.3	47.1	53.1
37	54.8	63.5	69.4

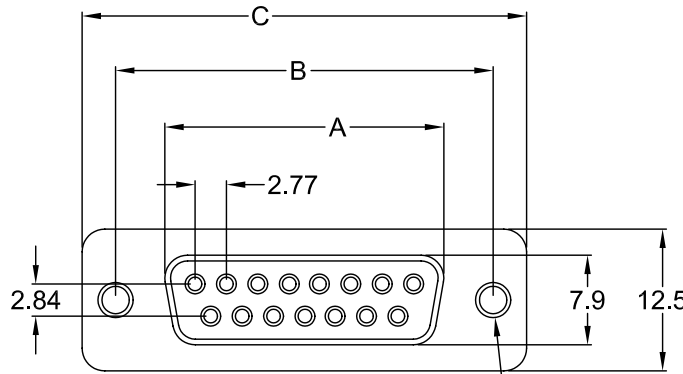

2X #4-40 UNC
THREAD

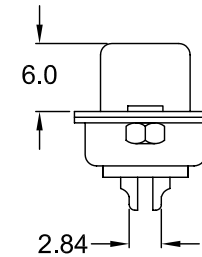
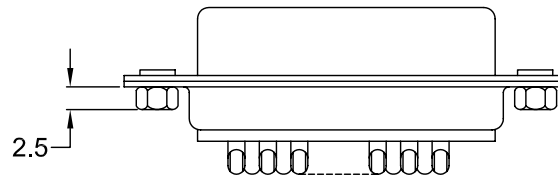

-X-XX: SEE ORDERING CODE FOR OPTIONS

REVISIONS	CHNG	CHK	APPR
	DATE	CHANGE	
REV	DATE	CHANGE	APPR

TOLERANCE UNLESS OTHERWISE SPECIFIED	
X	± 1
X.X	± 0.4
X.XX	± 0.20

Power Dynamics, Inc.
 Phone: 973 560-0019 Whippany, New Jersey Fax: 973 560-0076

PART: STRAIGHT FEMALE D-SUB
 SOLDER CUP

DRAWN BY	DF	DATE:	2/9/06
CHECK BY		DATE:	
APPR BY		DATE:	

PART #:	PDI-XXRS-SX-XX	SHEET	1 of 1
SIZE:	A	ALL DIMENSIONS FOR REFERENCE ONLY DIMENSIONS ARE IN MILLIMETERS	
SCALE:	NTS	REV:	

6

5

4

3

2

1

MATERIAL AND FINISH

Shell: Steel, Tin plated.
 Pin contact: Brass, Gold plating over Nickel.
 Insulator: PBT & Glass filled reinforced, UL 94V-0 rated.

ELECTRICAL SPECIFICATIONS:

Rated current: 3A
 Rated voltage: 250VAC
 Insulation resistance: 3000 Mohm min @ 500VDC
 Dielectric withstanding voltage: 1000VAC / 1 MIN.
 Contact resistance: 15 mohm max.

ENVIRONMENTAL:

Operating temperature: -55°C to +105°C

NOTE: Replace first XX in part number with number of positions

POSITION	A	B	C
09	16.92	25.0	30.8
15	25.25	33.3	39.2
25	38.96	47.1	53.1
37	55.42	63.5	69.4

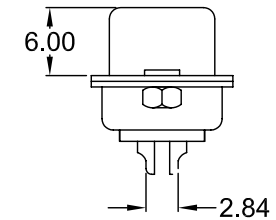
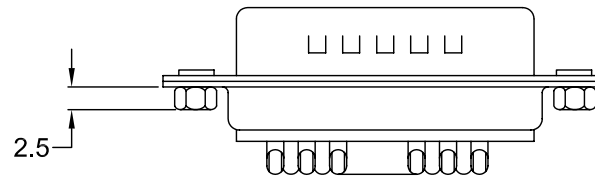
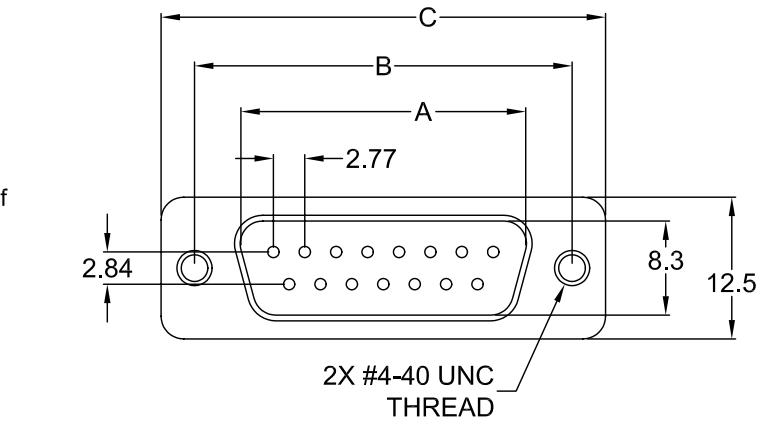

-X-XX: SEE ORDERING CODE FOR OPTIONS

TOLERANCE UNLESS OTHERWISE SPECIFIED	
X	± 1
X.X	± 0.4
X.XX	± 0.20

DRAWN BY: DF	DATE: 2/9/06
CHECK BY:	DATE:
APPR BY:	DATE:

Power Dynamics, Inc.
 Phone: 973 560-0019 Whippany, New Jersey Fax: 973 560-0076

PART: STRAIGHT MALE D-SUB
 SOLDER CUP

PART #: **PDI-XXSS-SX-XX**

SIZE: A
 SCALE: NTS

ALL DIMENSIONS FOR REFERENCE ONLY
 DIMENSIONS ARE IN MILLIMETERS

SHEET 1 of 1
 REV:

REVISIONS	CHNG	CHK	APPR
REV	DATE	CHANGE	

6

5

4

3

2

1

MATERIAL AND FINISH

Shell: steel, tin plated.
Pin contact: Brass, gold Plating over Nickel.
Insulator: PBT & glass filled reinforced, UL 94V-0 rated.

Operating temperature: -55°C to +105°C

ELECTRICAL SPECIFICATIONS:

Rated current: 3A
Rated voltage: 250VAC
Insulation resistance: 3000 Mohm min @ 500VDC
Dielectric withstanding voltage: 1000VAC / 1 MIN.
Contact resistance: 15 mohm

NOTE: Replace first XX in part number with number of positions.

POSITION	A	B	C
09	16.3	25.0	30.8
15	24.6	33.3	39.2
25	38.3	47.1	53.1
37	54.8	63.5	69.4

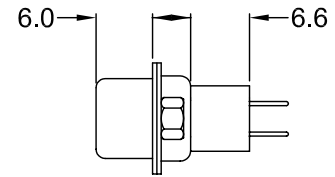
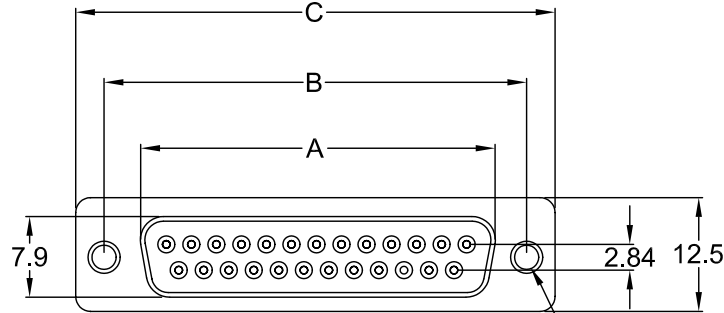

2X #4-40 UNC
THREAD

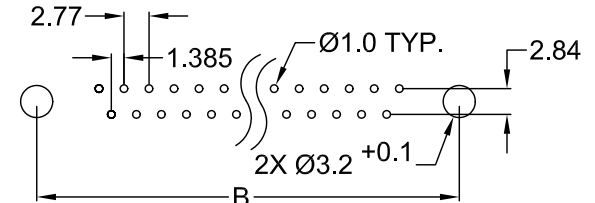
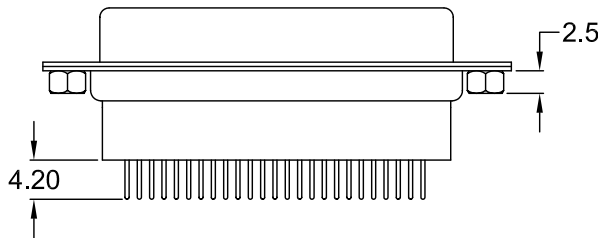

RECOMMENDED
PCB LAYOUT

-X-XX: SEE ORDERING CODE FOR OPTIONS

TOLERANCE UNLESS OTHERWISE SPECIFIED	
X	± 1
X.X	± 0.4
X.XX	± 0.20

Power Dynamics, Inc.
Phone: 973 560-0019 Whippany, New Jersey Fax: 973 560-0076

PART: STRAIGHT FEMALE D-SUB
EXTENDED PC PINS

DRAWN BY	DF	DATE:	2/9/06
CHECK BY		DATE:	
APPR BY		DATE:	

PART #:	PDI-XXRS-EX-XX	SHEET	1 of 1
SIZE:	A	ALL DIMENSIONS FOR REFERENCE ONLY DIMENSIONS ARE IN MILLIMETERS	REV:
SCALE:	NTS		

D

D

C

C

B

B

A

A

6

5

4

3

2

1

REV	DATE	CHANGE	CHKG	CHKD	APPR

REVISIONS

6

5

4

3

2

1

MATERIAL AND FINISH

Shell: Steel, Tin plated.
Pin contact: Brass, Gold plating over Nickel.
Insulator: PBT, UL 94V-0 rated.

ELECTRICAL SPECIFICATIONS:

Rated current: 3A max.
Rated voltage: 250VAC max.
Insulation resistance: 3000 Mohm min. @ 500VDC
Dielectric withstanding voltage: 1000VAC / 1 MIN.
Contact resistance: 15 mohm max.

ENVIRONMENTAL:

Operating temperature: -55°C to +105°C

NOTE: Replace first XX in part number with number of positions.

POSITION	A	B	C
09	16.92	25.0	30.8
15	25.25	33.3	39.2
25	38.96	47.1	53.1
37	55.42	63.5	69.4

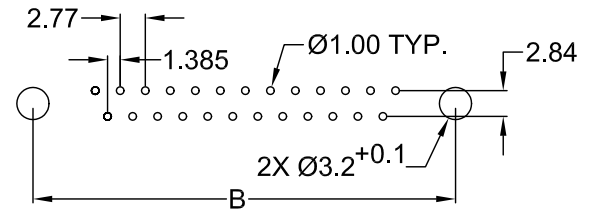
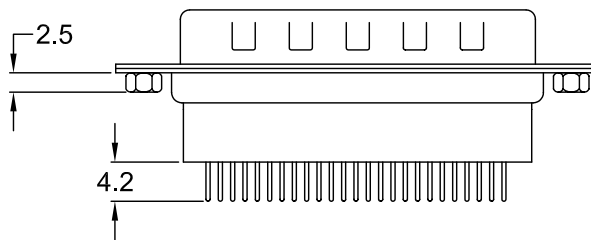
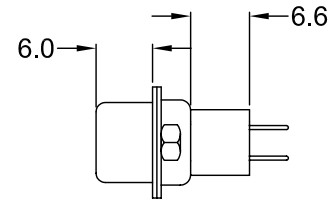
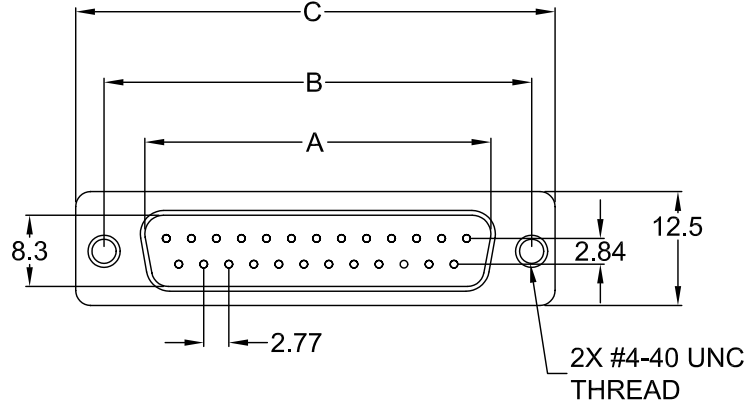

RECOMMENDED PCB LAYOUT

-X-XX: SEE ORDERING CODE FOR OPTIONS

TOLERANCE UNLESS OTHERWISE SPECIFIED	
X	± 1
X.X	± 0.4
X.XX	± 0.20

Power Dynamics, Inc.
Phone: 973 560-0019 Whippany, New Jersey Fax: 973 560-0076

PART: STRAIGHT MALE D-SUB
EXTENDED PC PINS

DRAWN BY	DF	DATE:	2/9/06
CHECK BY		DATE:	
APPR BY		DATE:	

PART #:	PDI-XXSS-EX-XX	SHEET	1 of 1
SIZE:	A	ALL DIMENSIONS FOR REFERENCE ONLY DIMENSIONS ARE IN MILLIMETERS	REV:
SCALE:	NTS		

D

C

B

A

D

C

B

A

6

5

4

3

2

1

REV	DATE	CHANGE	CHKG	CHK	APPR