

8-bit Microcontroller

CMOS

F²MC-8FX MB95200H/210H Series

**MB95F204H/F204K/F203H/F203K/F202H/F202K
MB95F214H/F214K/F213H/F213K/F212H/F212K**

■ DESCRIPTION

MB95200H/210H is a series of general-purpose, single-chip microcontrollers. In addition to a compact instruction set, the microcontrollers of this series contain a variety of peripheral resources.

Note: F²MC is the abbreviation of FUJITSU Flexible Microcontroller.

■ FEATURES

- F²MC-8FX CPU core
 - Instruction set optimized for controllers
 - Multiplication and division instructions
 - 16-bit arithmetic operations
 - Bit test branch instructions
 - Bit manipulation instructions, etc.
- Clock (main OSC clock and sub-OSC clock are only available in **MB95F204H/F204K/F203H/F203K/F202H/F202K**)
 - Selectable main clock source
 - Main OSC clock (up to 16.25 MHz, maximum machine clock frequency: 8.125 MHz)
 - External clock (up to 32.5 MHz, maximum machine clock frequency: 16.25 MHz)
 - Main internal CR clock (1/8/10 MHz ± 3%, maximum machine clock frequency: 10 MHz)
 - Selectable subclock source
 - Sub-OSC clock (32.768 kHz)
 - External clock (32.768 kHz)
 - Sub-internal CR clock (typ: 100 kHz, min: 50 kHz, max: 200 kHz)
- Timer
 - 8/16-bit composite timer
 - Timebase timer
 - Watch prescaler
- LIN-UART (**MB95F204H/F204K/F203H/F203K/F202H/F202K**)
 - Full duplex double buffer
 - Capable of clock-synchronized serial data transfer and clock-asynchronized serial data transfer

(Continued)

MB95200H/210H Series

(Continued)

- External interrupt
 - Interrupt by edge detection (rising edge, falling edge, and both edges can be selected)
 - Can be used to wake up the device from different low-power consumption (standby) modes
- 8/10-bit A/D converter
 - 8-bit or 10-bit resolution can be selected.
- Low power consumption (standby) mode
 - Stop mode
 - Sleep mode
 - Watch mode
 - Timebase timer mode
- I/O port (max: 17) (**MB95F204K/F203K/F202K**)
 - General-purpose I/O ports (max):
CMOS I/O: 15, N-ch open drain: 2
- I/O port (max: 16) (**MB95F204H/F203H/F202H**)
 - General-purpose I/O ports (max):
CMOS I/O: 15, N-ch open drain: 1
- I/O port (max: 5) (**MB95F214K/F213K/F212K**)
 - General-purpose I/O ports (max):
CMOS I/O: 3, N-ch open drain: 2
- I/O port (max: 4) (**MB95F214H/F213H/F212H**)
 - General-purpose I/O ports (max):
CMOS I/O: 3, N-ch open drain: 1
- On-chip debug
 - 1-wire serial control
 - Serial writing supported (asynchronous mode)
- Hardware/software watchdog timer
 - Built-in hardware watchdog timer
- Low-voltage detection reset circuit
 - Built-in low-voltage detector
- Clock supervisor counter
 - Built-in clock supervisor counter function
- Programmable port input voltage level
 - CMOS input level / hysteresis input level
- Flash memory security function
 - Protects the contents of flash memory

MB95200H/210H Series

■ PRODUCT LINE-UP

Part number	MB95 F204H	MB95 F203H	MB95 F202H	MB95 F204K	MB95 F203K	MB95 F202K	MB95 F214H	MB95 F213H	MB95 F212H	MB95 F214K	MB95 F213K	MB95 F212K
Parameter												
Type	Flash memory product											
Clock supervisor counter	It supervises the main clock oscillation.											
ROM capacity	16 KB	8 KB	4 KB	16 KB	8 KB	4 KB	16 KB	8 KB	4 KB	16 KB	8 KB	4 KB
RAM capacity	496 B	496 B	240 B	496 B	496 B	240 B	496 B	496 B	240 B	496 B	496 B	240 B
Low-voltage detection reset	No			Yes			No			Yes		
Reset input	Dedicated			Software select			Dedicated			Software select		
CPU functions	Number of basic instructions : 136 Instruction bit length : 8 bits Instruction length : 1 to 3 bytes Data bit length : 1, 8, and 16 bits Minimum instruction execution time : 61.5 ns (with machine clock = 16.25 MHz) Interrupt processing time : 0.6 μs (with machine clock = 16.25 MHz)											
General-purpose I/O	I/O ports (max): 16 CMOS: 15, N-ch: 1			I/O ports (max): 17 CMOS: 15, N-ch: 2			I/O ports (max): 4 CMOS: 3, N-ch: 1			I/O ports (max): 5 CMOS: 3, N-ch: 2		
Timebase timer	Interrupt cycle : 0.256 ms - 8.3 s (when external clock = 4 MHz)											
Hardware/software watchdog timer	Reset generation cycle Main oscillation clock at 10 MHz : 105 ms (min) The sub-internal CR clock can be used as the source clock of the hardware watchdog.											
Wild register	It can be used to replace three bytes of data.											
LIN-UART	A wide range of communication speed can be selected by a dedicated reload timer. It has a full duplex double buffer. Clock-synchronized serial data transfer and clock-asynchronized serial data transfer is enabled. The LIN function can be used as a LIN master or a LIN slave.						No LIN-UART					
8/10-bit A/D converter	6 ch. 8-bit or 10-bit resolution can be selected.						2 ch.					
8/16-bit composite timer	2 ch.						1 ch. The timer can be configured as an "8-bit timer x 2 channels" or a "16-bit timer x 1 channel". It has built-in timer function, PWC function, PWM function and input capture function. Count clock: it can be selected from internal clocks (seven types) and external clocks. It can output square wave.					
External interrupt	6 ch.						2 ch. Interrupt by edge detection (rising edge, falling edge, or both edges can be selected.) It can be used to wake up the device from standby modes.					
On-chip debug	1-wire serial control It supports serial writing. (asynchronous mode)											

(Continued)

MB95200H/210H Series

(Continued)

Part number	MB95 F204H	MB95 F203H	MB95 F202H	MB95 F204K	MB95 F203K	MB95 F202K	MB95 F214H	MB95 F213H	MB95 F212H	MB95 F214K	MB95 F213K	MB95 F212K
Parameter												
Watch prescaler	Eight different time intervals can be selected.											
Flash memory	<p>It supports automatic programming, Embedded Algorithm, write/erase/erase-suspend/erase-resume commands.</p> <p>It has a flag indicating the completion of the operation of Embedded Algorithm.</p> <p>Number of write/erase cycles (min): 100000</p> <p>Data retention time: 20 years</p> <p>For write/erase, external Vpp(+10 V) input is required.</p> <p>Flash Security Feature for protecting the contents of the flash</p>											
Standby mode	Sleep mode, stop mode, watch mode, timebase timer mode											
Package	SDIP-24 SOP-20						DIP-8 SOP-8					

MB95200H/210H Series

■ PACKAGES AND CORRESPONDING PRODUCTS

Part number / Package	MB95 F204H	MB95 F203H	MB95 F202H	MB95 F204K	MB95 F203K	MB95 F202K	MB95 F214H	MB95 F213H	MB95 F212H	MB95 F214K	MB95 F213K	MB95 F212K
24-pin plastic SDIP	○	○	○	○	○	○	X	X	X	X	X	X
20-pin plastic SOP	○	○	○	○	○	○	X	X	X	X	X	X
8-pin plastic DIP	X	X	X	X	X	X	○	○	○	○	○	○
8-pin plastic SOP	X	X	X	X	X	X	○	○	○	○	○	○

○: Available

X: Unavailable

■ DIFFERENCES AMONG PRODUCTS AND NOTES ON PRODUCT SELECTION

- Current consumption

When using the on-chip debug function, take account of the current consumption of flash erase/program.

For details of current consumption, see “■ ELECTRICAL CHARACTERISTICS”.

- Package

For details of information on each package, see “■ PACKAGES AND CORRESPONDING PRODUCTS” and “■ PACKAGE DIMENSIONS”.

- Operating voltage

The operating voltage varies, depending on whether the on-chip debug function is used or not.

For details of the operating voltage, see “■ ELECTRICAL CHARACTERISTICS”.

- On-chip debug function

The on-chip debug function requires that V_{CC} , V_{SS} and 1 serial-wire be connected to an evaluation tool. In addition, if the flash memory data has to be updated, the RSTX/PF2 pin must also be connected to the same evaluation tool.

■ PIN ASSIGNMENT

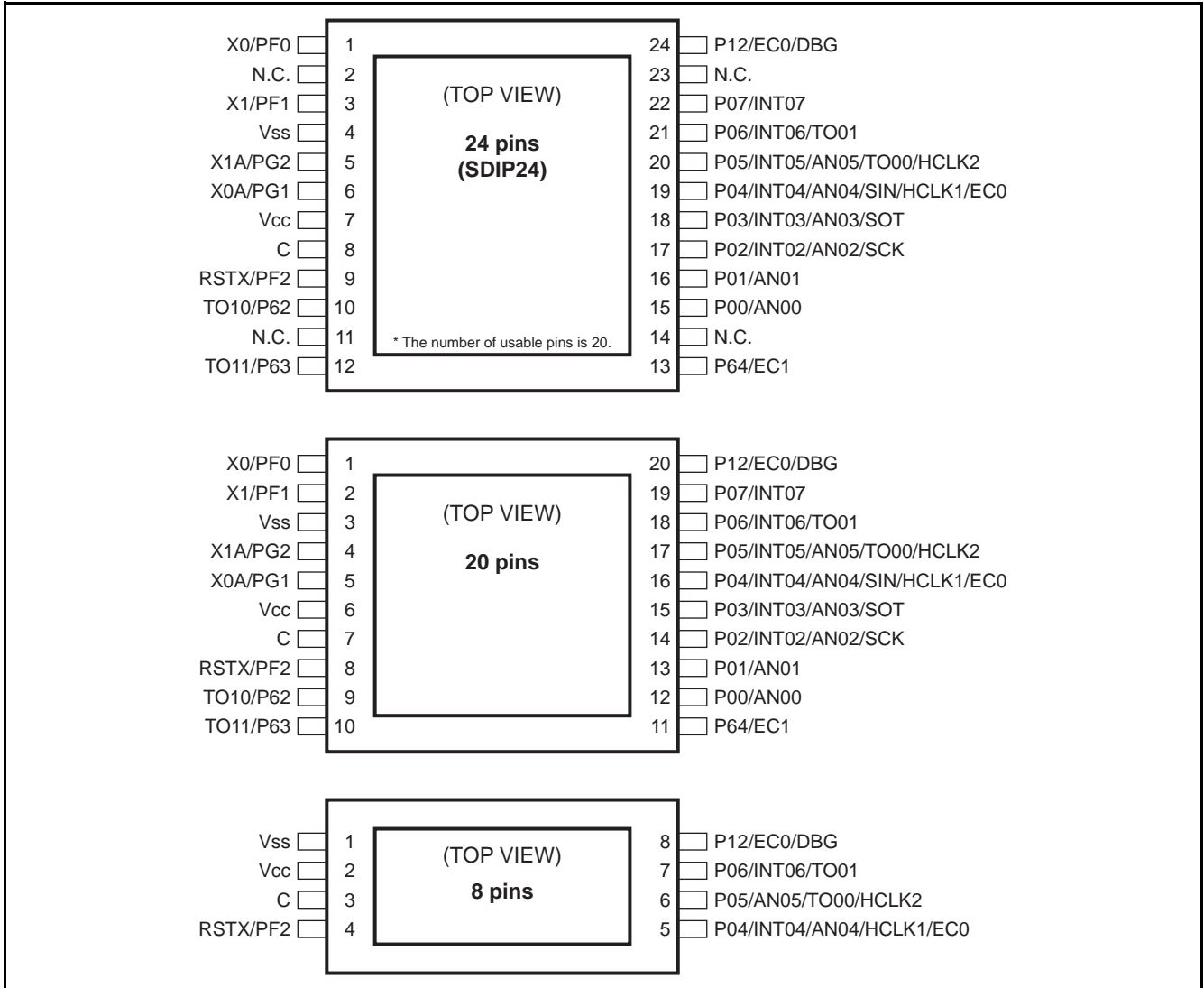

MB95200H/210H Series

■ PIN DESCRIPTION (MB95200H Series)

Pin no.	Pin name	I/O circuit type*	Function
1	PF0/X0	B	General-purpose I/O port This pin is also used as the main clock input oscillation pin.
2	PF1/X1	B	General-purpose I/O port This pin is also used as the main clock input/output oscillation pin.
3	V _{ss}	—	Power supply pin (GND)
4	PG2/X1A	C	General-purpose I/O port This pin is also used as the subclock input/output oscillation pin.
5	PG1/X0A	C	General-purpose I/O port This pin is also used as the subclock input oscillation pin.
6	V _{cc}	—	Power supply pin
7	C	—	Capacitor connection pin
8	PF2/RSTX	A	General-purpose I/O port This pin is also used as a reset pin. This pin is a dedicated reset pin in MB95F204H/F203H/F202H.
9	P62/TO10	D	General-purpose I/O port High-current port This pin is also used as the 8/16-bit composite timer ch. 1 output.
10	P63/TO11	D	General-purpose I/O port High-current port This pin is also used as the 8/16-bit composite timer ch. 1 output.
11	P64/EC1	D	General-purpose I/O port This pin is also used as the 8/16-bit composite timer ch. 1 clock input.
12	P00/AN00	E	General-purpose I/O port This pin is also used as the A/D converter analog input.
13	P01/AN01	E	General-purpose I/O port This pin is also used as the A/D converter analog input.
14	P02/INT02/AN02/ SCK	E	General-purpose I/O port This pin is also used as the external interrupt input. This pin is also used as the A/D converter analog input. This pin is also used as the LIN-UART clock I/O.
15	P03/INT03/AN03/ SOT	E	General-purpose I/O port This pin is also used as the external interrupt input. This pin is also used as the A/D converter analog input. This pin is also used as the LIN-UART data output.
16	P04/INT04/AN04/ SIN/HCLK1/EC0	F	General-purpose I/O port This pin is also used as the external interrupt input. This pin is also used as the A/D converter analog input. This pin is also used as the LIN-UART data input. This pin is also used as the external clock input. This pin is also used as the 8/16-bit composite timer ch. 0 clock input.

(Continued)

MB95200H/210H Series

(Continued)

Pin no.	Pin name	I/O circuit type*	Function
17	P05/INT05/AN05/ TO00/HCLK2	E	General-purpose I/O port High-current port This pin is also used as the external interrupt input. This pin is also used as the A/D converter analog input. This pin is also used as the 8/16-bit composite timer ch. 0 output. This pin is also used as the external clock input.
18	P06/INT06/TO01	G	General-purpose I/O port High-current port This pin is also used as the external interrupt input. This pin is also used as the 8/16-bit composite timer ch. 0 output.
19	P07/INT07	G	General-purpose I/O port This pin is also used as the external interrupt input.
20	P12/EC0/DBG	H	General-purpose I/O port This pin is also used as the DBG input pin. This pin is also used as the 8/16-bit composite timer ch. 0 clock input.

*: For the I/O circuit types, see "■ I/O CIRCUIT TYPE".

MB95200H/210H Series

■ PIN DESCRIPTION (MB95210H Series)

Pin no.	Pin name	I/O circuit type*	Function
1	V _{SS}	—	Power supply pin (GND)
2	V _{CC}	—	Power supply pin
3	C	—	Capacitor connection pin
4	RSTX/PF2	A	General-purpose I/O port This pin is also used as a reset pin. This pin is a dedicated reset pin in MB95F214H/F213H/F212H.
5	P04/INT04/AN04/ HCLK1/EC0	E	General-purpose I/O port This pin is also used as the external interrupt input. This pin is also used as the A/D converter analog input. This pin is also used as the external clock input. This pin is also used as the 8/16-bit composite timer ch. 0 clock input.
6	P05/AN05/TO00/ HCLK2	E	General-purpose I/O port High-current port This pin is also used as the A/D converter analog input. This pin is also used as the 8/16-bit composite timer ch. 0 output. This pin is also used as the external clock input.
7	P06/INT06/TO01	G	General-purpose I/O port High-current port This pin is also used as the external interrupt input. This pin is also used as the 8/16-bit composite timer ch. 0 output.
8	P12/EC0/DBG	H	General-purpose I/O port This pin is also used as the DBG input pin. This pin is also used as the 8/16-bit composite timer ch. 0 clock input.

*: For the I/O circuit types, see "■ I/O CIRCUIT TYPE".

■ I/O CIRCUIT TYPE

Type	Circuit	Remarks
A		<ul style="list-style-type: none"> • N-ch open drain output • Hysteresis input • Reset output
B		<ul style="list-style-type: none"> • Oscillation circuit • High-speed side Feedback resistance: approx. 1 MΩ • CMOS output • Hysteresis input
C		<ul style="list-style-type: none"> • Oscillation circuit • Low-speed side Feedback resistance: approx. 10 MΩ • CMOS output • Hysteresis input • Pull-up control available

(Continued)

MB95200H/210H Series

(Continued)

Type	Circuit	Remarks
D	<p> P-ch Digital output Digital output Standby control Hysteresis input N-ch </p>	<ul style="list-style-type: none"> • CMOS output • Hysteresis input
E	<p> Pull-up control Digital output Digital output Analog input A/D control Standby control Hysteresis input P-ch P-ch N-ch </p>	<ul style="list-style-type: none"> • CMOS output • Hysteresis input • Pull-up control available
F	<p> Pull-up control Digital output Digital output Analog input A/D control Standby control Hysteresis input CMOS input P-ch P-ch N-ch </p>	<ul style="list-style-type: none"> • CMOS output • Hysteresis input • CMOS input • Pull-up control available
G	<p> Pull-up control Digital output Digital output Standby control Hysteresis input P-ch P-ch N-ch </p>	<ul style="list-style-type: none"> • Hysteresis input • CMOS output • Pull-up control available
H	<p> Standby control Hysteresis input Digital output N-ch </p>	<ul style="list-style-type: none"> • N-ch open drain output • Hysteresis input

■ NOTES ON DEVICE HANDLING

• Preventing latch-ups

When using the device, ensure that the voltage applied does not exceed the maximum voltage rating.

In a CMOS IC, if a voltage higher than V_{CC} or a voltage lower than V_{SS} is applied to an input/output pin that is neither a medium-withstand voltage pin nor a high-withstand voltage pin, or if a voltage out of the rating range of power supply voltage mentioned in “1. Absolute Maximum Ratings” of ■ ELECTRICAL CHARACTERISTICS” is applied to the V_{CC} pin or the V_{SS} pin, a latch-up may occur.

When a latch-up occurs, power supply current increases significantly, which may cause a component to be thermally destroyed.

• Stabilizing supply voltage

Supply voltage must be stabilized.

A malfunction may occur when power supply voltage fluctuates rapidly even though the fluctuation is within the guaranteed operating range of the V_{CC} power supply voltage.

As a rule of voltage stabilization, suppress voltage fluctuation so that the fluctuation in V_{CC} ripple (p-p value) at the commercial frequency (50 Hz/60 Hz) does not exceed 10% of the standard V_{CC} value, and the transient fluctuation rate does not exceed 0.1 V/ms at a momentary fluctuation such as switching the power supply.

• Notes on using the external clock

When an external clock is used, oscillation stabilization wait time is required for power-on reset, wake-up from subclock mode or stop mode.

■ PIN CONNECTION

• Treatment of unused pins

If an unused input pin is left unconnected, a component may be permanently damaged due to malfunctions or latch-ups. Always pull up or pull down an unused input pin through a resistor of at least 2 k Ω . Set an unused input/output pin to the output state and leave it unconnected, or set it to the input state and treat it the same as an unused input pin. If there is an unused output pin, leave it unconnected.

• Power supply pins

To reduce unnecessary electro-magnetic emission, prevent malfunctions of strobe signals due to an increase in the ground level, and conform to the total output current standard, always connect the V_{CC} pin and the V_{SS} pin to the power supply and ground outside the device. In addition, connect the current supply source to the V_{CC} pin and the V_{SS} pin with low impedance.

It is also advisable to connect a ceramic bypass capacitor of approximately 0.1 μ F between the V_{CC} pin and the V_{SS} pin at a location close to this device.

• DBG pin

Connect the DBG pin directly to an external pull-up resistor.

To prevent the device from unintentionally entering the debug mode due to noise, minimize the distance between the DBG pin and the V_{CC} or V_{SS} pin when designing the layout of the printed circuit board.

The DBG pin should not stay at “L” level after power-on until the reset output is released.

• RSTX pin

Connect the RSTX pin directly to an external pull-up resistor.

To prevent the device from unintentionally entering the reset mode due to noise, minimize the distance between the RSTX pin and the V_{CC} or V_{SS} pin when designing the layout of the printed circuit board.

The RSTX/PF2 pin functions as the reset input/output pin after power-on. In addition, the reset output can be enabled by the RSTOE bit of the SYSC register, and the reset input function or the general purpose I/O function can be selected by the RSTEN bit of the SYSC register.

MB95200H/210H Series

- C pin

Use a ceramic capacitor or a capacitor with equivalent frequency characteristics. The bypass capacitor for the V_{CC} pin must have a capacitance larger than C_s . For the connection to a smoothing capacitor C_s , see the diagram below. To prevent the device from unintentionally entering an unknown mode due to noise, minimize the distance between the C pin and C_s and the distance between C_s and the V_{SS} pin when designing the layout of a printed circuit board.

- DBG/RSTX/C pin connection diagram

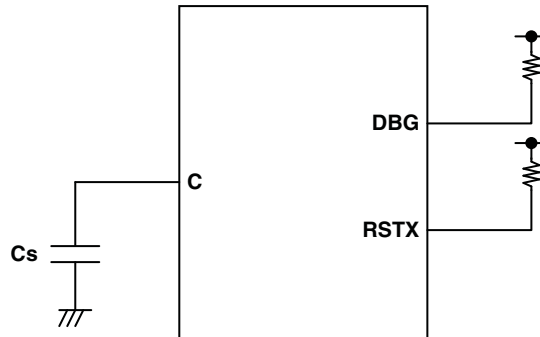

■ BLOCK DIAGRAM (MB95200H Series)

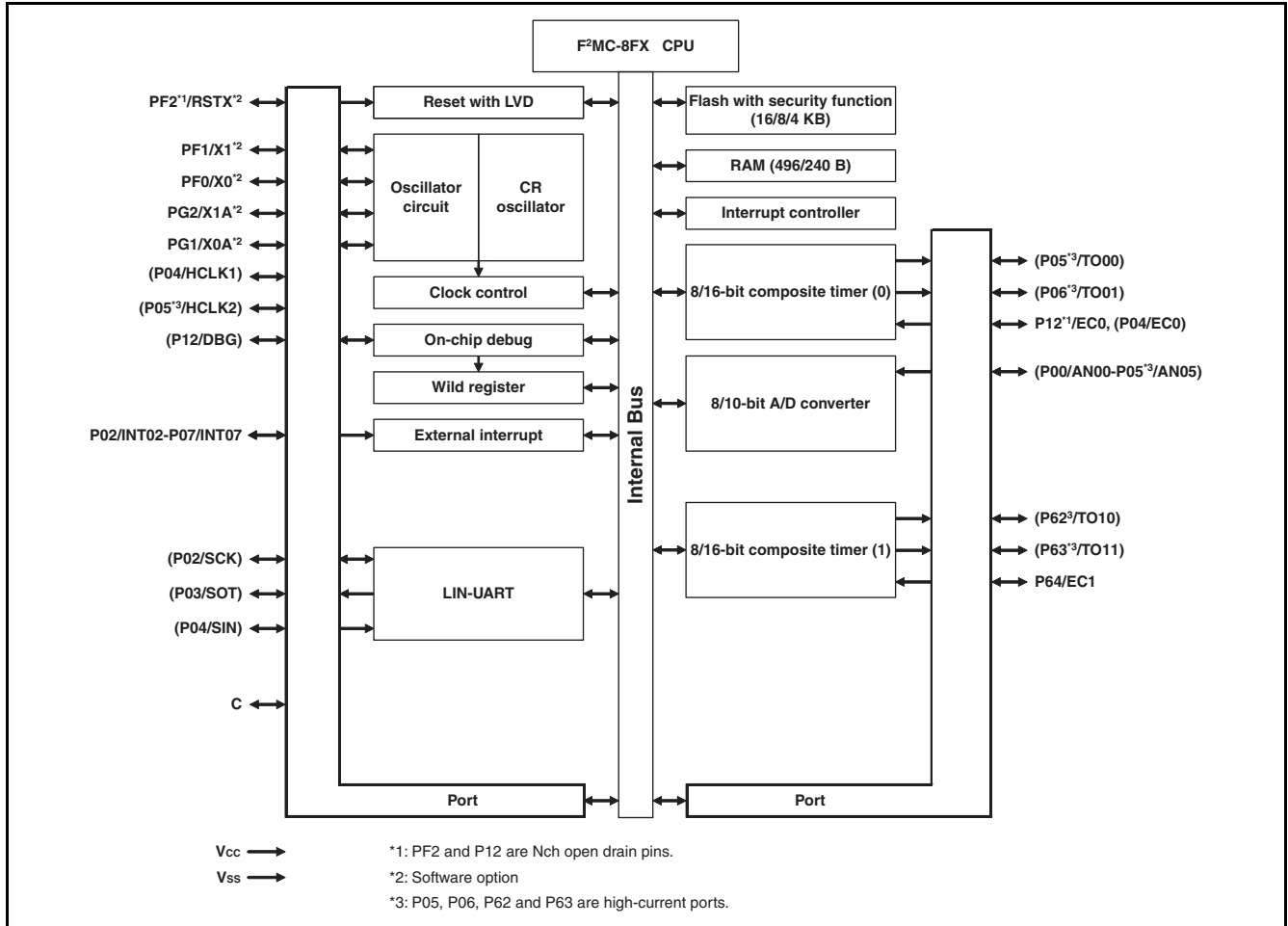

MB95200H/210H Series

■ BLOCK DIAGRAM (MB95210H Series)

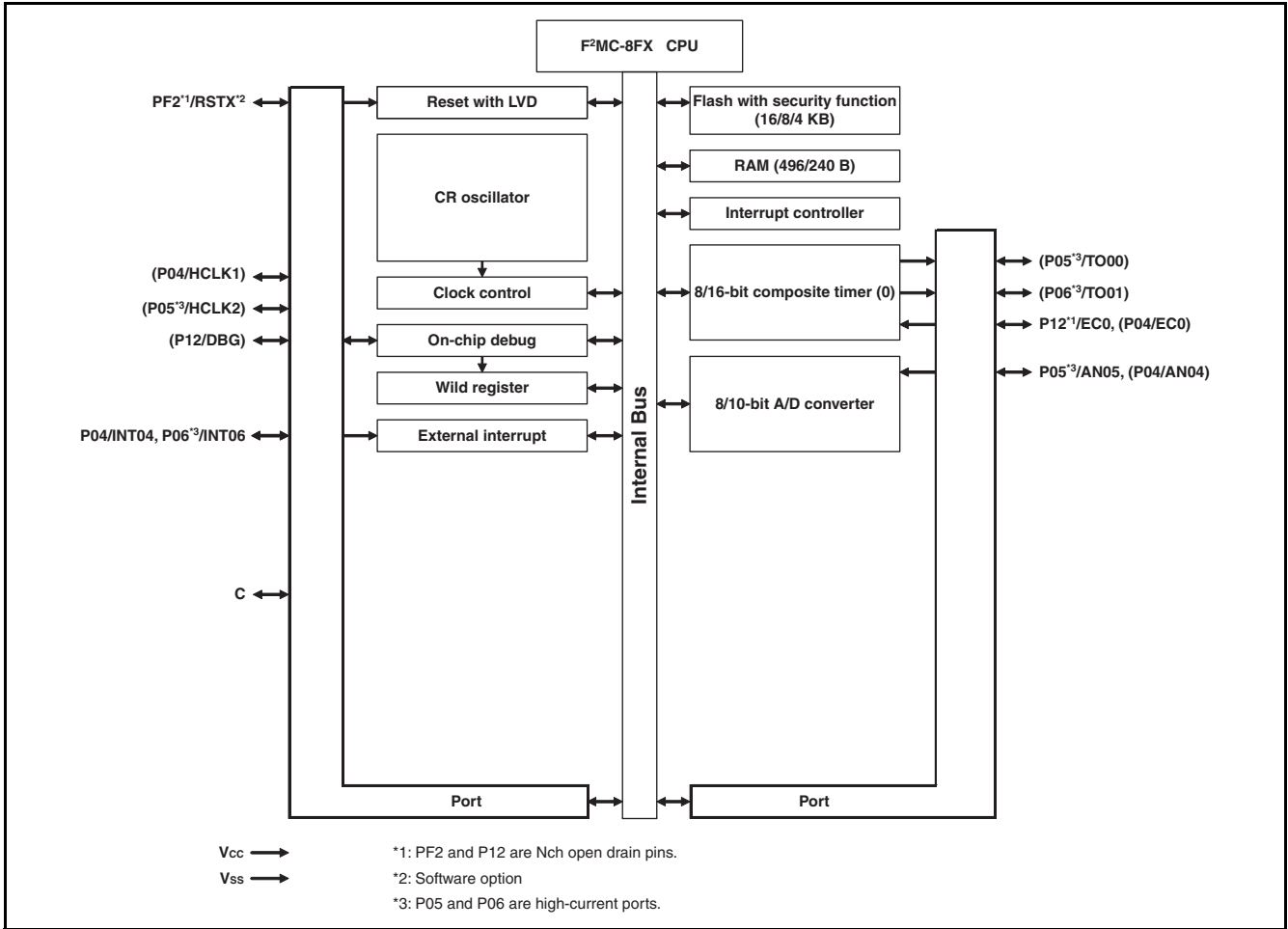

■ CPU CORE

• Memory Space

The memory space of the MB95200H/210H Series is 64 KB in size, and consists of an I/O area, a data area, and a program area. The memory space includes areas intended for specific purposes such as general-purpose registers and a vector table. The memory maps of the MB95200H/210H Series are shown below.

• Memory Maps

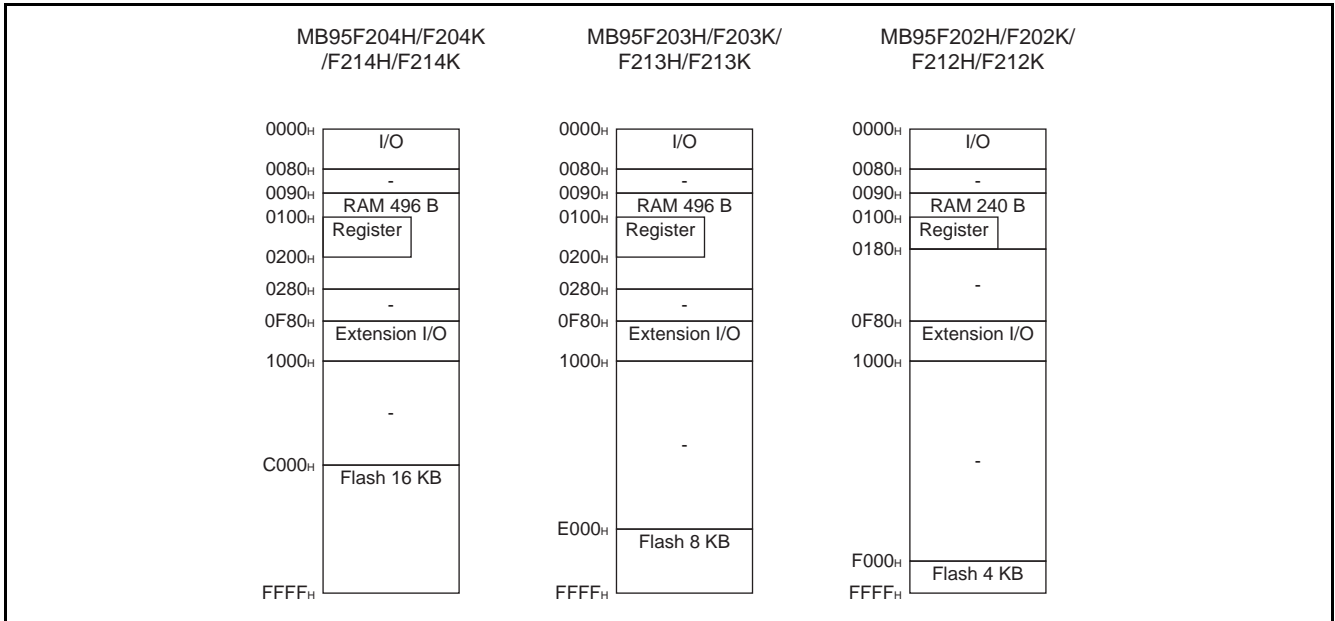

MB95200H/210H Series

■ I/O MAP (MB95200H Series)

Address	Register abbreviation	Register name	R/W	Initial value
0000 _H	PDR0	Port 0 data register	R/W	00000000 _B
0001 _H	DDR0	Port 0 direction register	R/W	00000000 _B
0002 _H	PDR1	Port 1 data register	R/W	00000000 _B
0003 _H	DDR1	Port 1 direction register	R/W	00000000 _B
0004 _H	—	(Disabled)	—	—
0005 _H	WATR	Oscillation stabilization wait time setting register	R/W	11111111 _B
0006 _H	—	(Disabled)	—	—
0007 _H	SYCC	System clock control register	R/W	XXXXXX11 _B
0008 _H	STBC	Standby control register	R/W	0000XXX _B
0009 _H	RSRR	Reset source register	R	XXXXXXXX _B
000A _H	TBTC	Timebase timer control register	R/W	00000000 _B
000B _H	WPCR	Watch prescaler control register	R/W	00000000 _B
000C _H	WDTC	Watchdog timer control register	R/W	00000000 _B
000D _H	SYCC2	System clock control register 2	R/W	XX100011 _B
000E _H to 0015 _H	—	(Disabled)	—	—
0016 _H	PDR6	Port 6 data register	R/W	00000000 _B
0017 _H	DDR6	Port 6 direction register	R/W	00000000 _B
0018 _H to 0027 _H	—	(Disabled)	—	—
0028 _H	PDRF	Port F data register	R/W	00000000 _B
0029 _H	DDRF	Port F direction register	R/W	00000000 _B
002A _H	PDRG	Port G data register	R/W	00000000 _B
002B _H	DDRG	Port G direction register	R/W	00000000 _B
002C _H	PUL0	Port 0 pull-up register	R/W	00000000 _B
002D _H to 0034 _H	—	(Disabled)	—	—
0035 _H	PULG	Port G pull-up register	R/W	00000000 _B
0036 _H	T01CR1	8/16-bit composite timer 01 status control register 1 ch. 0	R/W	00000000 _B
0037 _H	T00CR1	8/16-bit composite timer 00 status control register 1 ch. 0	R/W	00000000 _B
0038 _H	T11CR1	8/16-bit composite timer 11 status control register 1 ch. 1	R/W	00000000 _B
0039 _H	T10CR1	8/16-bit composite timer 10 status control register 1 ch. 1	R/W	00000000 _B
003A _H to 0048 _H	—	(Disabled)	—	—
0049 _H	EIC10	External interrupt circuit control register ch. 2/ch. 3	R/W	00000000 _B

(Continued)

MB95200H/210H Series

Address	Register abbreviation	Register name	R/W	Initial value
004A _H	EIC20	External interrupt circuit control register ch. 4/ch. 5	R/W	00000000 _B
004B _H	EIC30	External interrupt circuit control register ch. 6/ch. 7	R/W	00000000 _B
004C _H to 004F _H	—	(Disabled)	—	—
0050 _H	SCR	LIN-UART serial control register	R/W	00000000 _B
0051 _H	SMR	LIN-UART serial mode register	R/W	00000000 _B
0052 _H	SSR	LIN-UART serial status register	R/W	00001000 _B
0053 _H	RDR/TDR	LIN-UART receive/transmit data register	R/W	00000000 _B
0054 _H	ESCR	LIN-UART extended status control register	R/W	00000100 _B
0055 _H	ECCR	LIN-UART extended communication control register	R/W	000000XX _B
0056 _H to 006B _H	—	(Disabled)	—	—
006C _H	ADC1	8/10-bit A/D converter control register 1	R/W	00000000 _B
006D _H	ADC2	8/10-bit A/D converter control register 2	R/W	00000000 _B
006E _H	ADDH	8/10-bit A/D converter data register (Upper)	R/W	00000000 _B
006F _H	ADDL	8/10-bit A/D converter data register (Lower)	R/W	00000000 _B
0070 _H to 0071 _H	—	(Disabled)	—	—
0072 _H	FSR	Flash memory status register	R/W	000X0000 _B
0073 _H to 0075 _H	—	(Disabled)	—	—
0076 _H	WREN	Wild register address compare enable register	R/W	00000000 _B
0077 _H	WROR	Wild register data test setting register	R/W	00000000 _B
0078 _H	—	Mirror of register bank pointer (RP) and direct bank pointer (DP)	—	—
0079 _H	ILR0	Interrupt level setting register 0	R/W	11111111 _B
007A _H	ILR1	Interrupt level setting register 1	R/W	11111111 _B
007B _H	ILR2	Interrupt level setting register 2	R/W	11111111 _B
007C _H	ILR3	Interrupt level setting register 3	R/W	11111111 _B
007D _H	ILR4	Interrupt level setting register 4	R/W	11111111 _B
007E _H	ILR5	Interrupt level setting register 5	R/W	11111111 _B
007F _H	—	(Disabled)	—	—
0F80 _H	WRARH0	Wild register address setting register (Upper) ch. 0	R/W	00000000 _B

(Continued)

MB95200H/210H Series

Address	Register abbreviation	Register name	R/W	Initial value
0F81 _H	WRARL0	Wild register address setting register (Lower) ch. 0	R/W	00000000 _B
0F82 _H	WRDR0	Wild register data setting register ch. 0	R/W	00000000 _B
0F83 _H	WRARH1	Wild register address setting register (Upper) ch. 1	R/W	00000000 _B
0F84 _H	WRARL1	Wild register address setting register (Lower) ch. 1	R/W	00000000 _B
0F85 _H	WRDR1	Wild register data setting register ch. 1	R/W	00000000 _B
0F86 _H	WRARH2	Wild register address setting register (Upper) ch. 2	R/W	00000000 _B
0F87 _H	WRARL2	Wild register address setting register (Lower) ch. 2	R/W	00000000 _B
0F88 _H	WRDR2	Wild register data setting register ch. 2	R/W	00000000 _B
0F89 _H to 0F91 _H	—	(Disabled)	—	—
0F92 _H	T01CR0	8/16-bit composite timer 01 status control register 0 ch. 0	R/W	00000000 _B
0F93 _H	T00CR0	8/16-bit composite timer 00 status control register 0 ch. 0	R/W	00000000 _B
0F94 _H	T01DR	8/16-bit composite timer 01 data register ch. 0	R/W	00000000 _B
0F95 _H	T00DR	8/16-bit composite timer 00 data register ch. 0	R/W	00000000 _B
0F96 _H	TMCR0	8/16-bit composite timer 00/01 timer mode control register ch. 0	R/W	00000000 _B
0F97 _H	T11CR0	8/16-bit composite timer 11 status control register 0 ch. 1	R/W	00000000 _B
0F98 _H	T10CR0	8/16-bit composite timer 10 status control register 0 ch. 1	R/W	00000000 _B
0F99 _H	T11DR	8/16-bit composite timer 11 data register ch. 1	R/W	00000000 _B
0F9A _H	T10DR	8/16-bit composite timer 10 data register ch. 1	R/W	00000000 _B
0F9B _H	TMCR1	8/16-bit composite timer 10/11 timer mode control register ch. 1	R/W	00000000 _B
0F9C _H to 0FBB _H	—	(Disabled)	—	—
0FBC _H	BGR1	LIN-UART baud rate generator register 1	R/W	00000000 _B
0FBD _H	BGR0	LIN-UART baud rate generator register 0	R/W	00000000 _B
0FBE _H to 0FC2 _H	—	(Disabled)	—	—
0FC3 _H	AIDRL	A/D input disable register (Lower)	R/W	00000000 _B
0FC4 _H to 0FE3 _H	—	(Disabled)	—	—
0FE4 _H	CRTH	Main CR clock trimming register (Upper)	R/W	1XXXXXXX _B
0FE5 _H	CRTL	Main CR clock trimming register (Lower)	R/W	000XXXXX _B

(Continued)

(Continued)

Address	Register abbreviation	Register name	R/W	Initial value
0FE6 _H to 0FE7 _H	—	(Disabled)	—	—
0FE8 _H	SYSC	System configuration register	R/W	11000011 _B
0FE9 _H	CMCR	Clock monitoring control register	R/W	XX000000 _B
0FEA _H	CMDR	Clock monitoring data register	R/W	00000000 _B
0FEB _H	WDTH	Watchdog timer selection ID register (Upper)	R/W	XXXXXXXX _B
0FEC _H	WDTL	Watchdog timer selection ID register (Lower)	R/W	XXXXXXXX _B
0FED _H	—	(Disabled)	—	—
0FEE _H	ILSR	Input level select register	R/W	00000000 _B
0FEF _H to 0FFF _H	—	(Disabled)	—	—

- R/W access symbols

R/W : Readable / Writable

R : Read only

W : Write only

- Initial value symbols

0 : The initial value of this bit is "0".

1 : The initial value of this bit is "1".

X : The initial value of this bit is undefined.

Note: Do not write to an address that is "(Disabled)". If a "(Disabled)" address is read, an undefined value is returned.

MB95200H/210H Series

■ I/O MAP (MB95210H Series)

Address	Register abbreviation	Register name	R/W	Initial value
0000 _H	PDR0	Port 0 data register	R/W	00000000 _B
0001 _H	DDR0	Port 0 direction register	R/W	00000000 _B
0002 _H	PDR1	Port 1 data register	R/W	00000000 _B
0003 _H	DDR1	Port 1 direction register	R/W	00000000 _B
0004 _H	—	(Disabled)	—	—
0005 _H	WATR	Oscillation stabilization wait time setting register	R/W	11111111 _B
0006 _H	—	(Disabled)	—	—
0007 _H	SYCC	System clock control register	R/W	XXXXXX11 _B
0008 _H	STBC	Standby control register	R/W	0000XXX _B
0009 _H	RSRR	Reset source register	R	XXXXXXXX _B
000A _H	TBTC	Timebase timer control register	R/W	00000000 _B
000B _H	WPCR	Watch prescaler control register	R/W	00000000 _B
000C _H	WDTC	Watchdog timer control register	R/W	00000000 _B
000D _H	SYCC2	System clock control register 2	R/W	XX100011 _B
000E _H to 0015 _H	—	(Disabled)	—	—
0016 _H	—	(Disabled)	—	—
0017 _H	—	(Disabled)	—	—
0018 _H to 0027 _H	—	(Disabled)	—	—
0028 _H	PDRF	Port F data register	R/W	00000000 _B
0029 _H	DDRF	Port F direction register	R/W	00000000 _B
002A _H	—	(Disabled)	—	—
002B _H	—	(Disabled)	—	—
002C _H	PUL0	Port 0 pull-up register	R/W	00000000 _B
002D _H to 0034 _H	—	(Disabled)	—	—
0035 _H	—	(Disabled)	—	—
0036 _H	T01CR1	8/16-bit composite timer 01 status control register 1 ch. 0	R/W	00000000 _B
0037 _H	T00CR1	8/16-bit composite timer 00 status control register 1 ch. 0	R/W	00000000 _B
0038 _H	—	(Disabled)	—	—
0039 _H	—	(Disabled)	—	—
003A _H to 0048 _H	—	(Disabled)	—	—
0049 _H	—	(Disabled)	—	—

(Continued)

MB95200H/210H Series

Address	Register abbreviation	Register name	R/W	Initial value
004A _H	EIC20	External interrupt circuit control register ch. 4	R/W	00000000 _B
004B _H	EIC30	External interrupt circuit control register ch. 6	R/W	00000000 _B
004C _H to 004F _H	—	(Disabled)	—	—
0050 _H	—	(Disabled)	—	—
0051 _H	—	(Disabled)	—	—
0052 _H	—	(Disabled)	—	—
0053 _H	—	(Disabled)	—	—
0054 _H	—	(Disabled)	—	—
0055 _H	—	(Disabled)	—	—
0056 _H to 006B _H	—	(Disabled)	—	—
006C _H	ADC1	8/10-bit A/D converter control register 1	R/W	00000000 _B
006D _H	ADC2	8/10-bit A/D converter control register 2	R/W	00000000 _B
006E _H	ADDH	8/10-bit A/D converter data register (Upper)	R/W	00000000 _B
006F _H	ADDL	8/10-bit A/D converter data register (Lower)	R/W	00000000 _B
0070 _H to 0071 _H	—	(Disabled)	—	—
0072 _H	FSR	Flash memory status register	R/W	000X0000 _B
0073 _H to 0075 _H	—	(Disabled)	—	—
0076 _H	WREN	Wild register address compare enable register	R/W	00000000 _B
0077 _H	WROR	Wild register data test setting register	R/W	00000000 _B
0078 _H	—	Mirror of register bank pointer (RP) and direct bank pointer (DP)	—	—
0079 _H	ILR0	Interrupt level setting register 0	R/W	11111111 _B
007A _H	ILR1	Interrupt level setting register 1	R/W	11111111 _B
007B _H	—	(Disabled)	—	—
007C _H	—	(Disabled)	—	—
007D _H	ILR4	Interrupt level setting register 4	R/W	11111111 _B
007E _H	ILR5	Interrupt level setting register 5	R/W	11111111 _B
007F _H	—	(Disabled)	—	—
0F80 _H	WRARH0	Wild register address setting register (Upper) ch. 0	R/W	00000000 _B
0F81 _H	WRARL0	Wild register address setting register (Lower) ch. 0	R/W	00000000 _B
0F82 _H	WRDR0	Wild register data setting register ch. 0	R/W	00000000 _B

(Continued)

MB95200H/210H Series

Address	Register abbreviation	Register name	R/W	Initial value
0F83 _H	WRARH1	Wild register address setting register (Upper) ch. 1	R/W	00000000 _B
0F84 _H	WRARL1	Wild register address setting register (Lower) ch. 1	R/W	00000000 _B
0F85 _H	WRDR1	Wild register data setting register ch. 1	R/W	00000000 _B
0F86 _H	WRARH2	Wild register address setting register (Upper) ch. 2	R/W	00000000 _B
0F87 _H	WRARL2	Wild register address setting register (Lower) ch. 2	R/W	00000000 _B
0F88 _H	WRDR2	Wild register data setting register ch. 2	R/W	00000000 _B
0F89 _H to 0F91 _H	—	(Disabled)	—	—
0F92 _H	T01CR0	8/16-bit composite timer 01 status control register 0 ch. 0	R/W	00000000 _B
0F93 _H	T00CR0	8/16-bit composite timer 00 status control register 0 ch. 0	R/W	00000000 _B
0F94 _H	T01DR	8/16-bit composite timer 01 data register ch. 0	R/W	00000000 _B
0F95 _H	T00DR	8/16-bit composite timer 00 data register ch. 0	R/W	00000000 _B
0F96 _H	TMCR0	8/16-bit composite timer 00/01 timer mode control register ch. 0	R/W	00000000 _B
0F97 _H	—	(Disabled)	—	—
0F98 _H	—	(Disabled)	—	—
0F99 _H	—	(Disabled)	—	—
0F9A _H	—	(Disabled)	—	—
0F9B _H	—	(Disabled)	—	—
0F9C _H to 0FBB _H	—	(Disabled)	—	—
0FBC _H	—	(Disabled)	—	—
0FBD _H	—	(Disabled)	—	—
0FBE _H to 0FC2 _H	—	(Disabled)	—	—
0FC3 _H	AIDRL	A/D input disable register (Lower)	R/W	00000000 _B
0FC4 _H to 0FE3 _H	—	(Disabled)	—	—
0FE4 _H	CRTH	Main CR clock trimming register (Upper)	R/W	1XXXXXXX _B
0FE5 _H	CRTL	Main CR clock trimming register (Lower)	R/W	000XXXXX _B
0FE6 _H to 0FE7 _H	—	(Disabled)	—	—
0FE8 _H	SYSC	System configuration register	R/W	11000011 _B

(Continued)

(Continued)

Address	Register abbreviation	Register name	R/W	Initial value
0FE9 _H	CMCR	Clock monitoring control register	R/W	XX000000 _B
0FEA _H	CMDR	Clock monitoring data register	R/W	00000000 _B
0FEB _H	WDTH	Watchdog timer selection ID register (Upper)	R/W	XXXXXXXX _B
0FEC _H	WDTL	Watchdog timer selection ID register (Lower)	R/W	XXXXXXXX _B
0FED _H	—	(Disabled)	—	—
0FEE _H	ILSR	Input level select register	R/W	00000000 _B
0FEF _H to 0FFF _H	—	(Disabled)	—	—

- R/W access symbols

R/W : Readable / Writable

R : Read only

W : Write only

- Initial value symbols

0 : The initial value of this bit is “0”.

1 : The initial value of this bit is “1”.

X : The initial value of this bit is undefined.

Note: Do not write to an address that is “(Disabled)”. If a “(Disabled)” address is read, an undefined value is returned.

MB95200H/210H Series

■ INTERRUPT SOURCE TABLE (MB95200H Series)

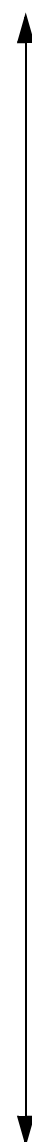
Interrupt source	Interrupt request number	Vector table address		Bit name of interrupt level setting register	Priority order of interrupt sources of the same level (occurring simultaneously)
		Upper	Lower		
External interrupt ch. 4	IRQ0	FFFA _H	FFFB _H	L00 [1:0]	<div style="text-align: center;">High</div>  <div style="text-align: center;">Low</div>
External interrupt ch. 5	IRQ1	FFF8 _H	FFF9 _H	L01 [1:0]	
External interrupt ch. 2	IRQ2	FFF6 _H	FFF7 _H	L02 [1:0]	
External interrupt ch. 6					
External interrupt ch. 3	IRQ3	FFF4 _H	FFF5 _H	L03 [1:0]	
External interrupt ch. 7					
—	IRQ4	FFF2 _H	FFF3 _H	L04 [1:0]	
8/16-bit composite timer ch. 0 (Lower)	IRQ5	FFF0 _H	FFF1 _H	L05 [1:0]	
8/16-bit composite timer ch. 0 (Upper)	IRQ6	FFEE _H	FFEF _H	L06 [1:0]	
LIN-UART (reception)	IRQ7	FFEC _H	FFED _H	L07 [1:0]	
LIN-UART (transmission)	IRQ8	FFEA _H	FFEB _H	L08 [1:0]	
—	IRQ9	FFE8 _H	FFE9 _H	L09 [1:0]	
—	IRQ10	FFE6 _H	FFE7 _H	L10 [1:0]	
—	IRQ11	FFE4 _H	FFE5 _H	L11 [1:0]	
—	IRQ12	FFE2 _H	FFE3 _H	L12 [1:0]	
—	IRQ13	FFE0 _H	FFE1 _H	L13 [1:0]	
8/16-bit composite timer ch. 1 (Upper)	IRQ14	FFDE _H	FFDF _H	L14 [1:0]	
—	IRQ15	FFDC _H	FFDD _H	L15 [1:0]	
—	IRQ16	FFDA _H	FFDB _H	L16 [1:0]	
—	IRQ17	FFD8 _H	FFD9 _H	L17 [1:0]	
8/10-bit A/D converter	IRQ18	FFD6 _H	FFD7 _H	L18 [1:0]	
Timebase timer	IRQ19	FFD4 _H	FFD5 _H	L19 [1:0]	
Watch prescaler	IRQ20	FFD2 _H	FFD3 _H	L20 [1:0]	
—	IRQ21	FFD0 _H	FFD1 _H	L21 [1:0]	
8/16-bit composite timer ch. 1 (Lower)	IRQ22	FFCE _H	FFCF _H	L22 [1:0]	
Flash memory	IRQ23	FFCC _H	FFCD _H	L23 [1:0]	

■ INTERRUPT SOURCE TABLE (MB95210H Series)

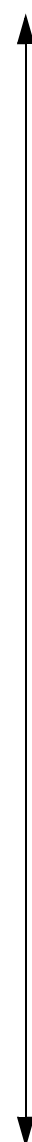
Interrupt source	Interrupt request number	Vector table address		Bit name of interrupt level setting register	Priority order of interrupt sources of the same level (occurring simultaneously)
		Upper	Lower		
External interrupt ch. 4	IRQ0	FFFA _H	FFFB _H	L00 [1:0]	<div style="text-align: center;">High</div>  <div style="text-align: center;">Low</div>
—	IRQ1	FFF8 _H	FFF9 _H	L01 [1:0]	
—	IRQ2	FFF6 _H	FFF7 _H	L02 [1:0]	
External interrupt ch. 6					
—	IRQ3	FFF4 _H	FFF5 _H	L03 [1:0]	
—					
—	IRQ4	FFF2 _H	FFF3 _H	L04 [1:0]	
8/16-bit composite timer ch. 0 (Lower)	IRQ5	FFF0 _H	FFF1 _H	L05 [1:0]	
8/16-bit composite timer ch. 0 (Upper)	IRQ6	FFEE _H	FFEF _H	L06 [1:0]	
—	IRQ7	FFEC _H	FFED _H	L07 [1:0]	
—	IRQ8	FFEA _H	FFEB _H	L08 [1:0]	
—	IRQ9	FFE8 _H	FFE9 _H	L09 [1:0]	
—	IRQ10	FFE6 _H	FFE7 _H	L10 [1:0]	
—	IRQ11	FFE4 _H	FFE5 _H	L11 [1:0]	
—	IRQ12	FFE2 _H	FFE3 _H	L12 [1:0]	
—	IRQ13	FFE0 _H	FFE1 _H	L13 [1:0]	
—	IRQ14	FFDE _H	FFDF _H	L14 [1:0]	
—	IRQ15	FFDC _H	FFDD _H	L15 [1:0]	
—	IRQ16	FFDA _H	FFDB _H	L16 [1:0]	
—	IRQ17	FFD8 _H	FFD9 _H	L17 [1:0]	
8/10-bit A/D converter	IRQ18	FFD6 _H	FFD7 _H	L18 [1:0]	
Timebase timer	IRQ19	FFD4 _H	FFD5 _H	L19 [1:0]	
Watch prescaler	IRQ20	FFD2 _H	FFD3 _H	L20 [1:0]	
—	IRQ21	FFD0 _H	FFD1 _H	L21 [1:0]	
—	IRQ22	FFCE _H	FFCF _H	L22 [1:0]	
Flash memory	IRQ23	FFCC _H	FFCD _H	L23 [1:0]	

MB95200H/210H Series

■ ELECTRICAL CHARACTERISTICS

1. Absolute Maximum Ratings

Parameter	Symbol	Rating		Unit	Remarks
		Min	Max		
Power supply voltage*1	V_{CC}	$V_{SS}-0.3$	$V_{SS}+6$	V	
Input voltage*1	V_I	$V_{SS}-0.3$	$V_{SS}+6$	V	*2
Output voltage*1	V_O	$V_{SS}-0.3$	$V_{SS}+6$	V	*2
Maximum clamp current	I_{CLAMP}	-2	+2	mA	Applicable to pins listed in *3
Total maximum clamp current	$\Sigma I_{CLAMP} $	—	20	mA	Applicable to pins listed in *3
“L” level maximum output current	I_{OL1}	—	15	mA	Other than P05, P06, P62 and P63*4
	I_{OL2}		15		P05, P06, P62 and P63*4
“L” level average current	I_{OLAV1}	—	4	mA	Other than P05, P06, P62 and P63*4 Average output current = operating current × operating ratio (1 pin)
	I_{OLAV2}		12		P05, P06, P62 and P63*4 Average output current = operating current × operating ratio (1 pin)
“L” level total maximum output current	ΣI_{OL}	—	100	mA	
“L” level total average output current	ΣI_{OLAV}	—	50	mA	Total average output current = operating current × operating ratio (Total number of pins)
“H” level maximum output current	I_{OH1}	—	-15	mA	Other than P05, P06, P62 and P63*4
	I_{OH2}		-15		P05, P06, P62 and P63*4
“H” level average current	I_{OHAV1}	—	-4	mA	Other than P05, P06, P62 and P63*4 Average output current = operating current × operating ratio (1 pin)
	I_{OHAV2}		-8		P05, P06, P62 and P63*4 Average output current = operating current × operating ratio (1 pin)
“H” level total maximum output current	ΣI_{OH}	—	-100	mA	
“H” level total average output current	ΣI_{OHAV}	—	-50	mA	Total average output current = operating current × operating ratio (Total number of pins)
Power consumption	P_d	—	320	mW	
Operating temperature	T_A	-40	+85	°C	
Storage temperature	T_{stg}	-55	+150	°C	

- *1: The parameter is based on $V_{SS} = 0.0$ V.
- *2: V_I and V_O must not exceed $V_{CC}+0.3$ V. V_I must not exceed the rated voltage. However, if the maximum current to/from an input is limited by means of an external component, the I_{CLAMP} rating is used instead of the V_I rating.
- *3: Applicable to the following pins: P00 to P07, P62 to P64, PG1, PG2, PF0, PF1 (P00 to P03, P07, P62 to P64, PG1, PG2, PF0 and PF1 are available in MB95F204H/F203H/F202H/F204K/F203K/F202K.)
 - Use under recommended operating conditions.
 - Use with DC voltage (current).
 - The HV (High Voltage) signal is an input signal exceeding the V_{CC} voltage. Always connect a limiting resistor between the HV (High Voltage) signal and the microcontroller before applying the HV (High Voltage) signal.
 - The value of the limiting resistor should be set to a value at which the current to be input to the microcontroller pin when the HV (High Voltage) signal is input is below the standard value, irrespective of whether the current is transient current or stationary current.
 - When the microcontroller drive current is low, such as in low power consumption modes, the HV (High Voltage) input potential may pass through the protective diode to increase the potential of the V_{CC} pin, affecting other devices.
 - If the HV (High Voltage) signal is input when the microcontroller power supply is off (not fixed at 0 V), since power is supplied from the pins, incomplete operations may be executed.
 - If the HV (High Voltage) input is input after power-on, since power is supplied from the pins, the voltage of power supply may not be sufficient to enable a power-on reset.
 - Do not leave the HV (High Voltage) input pin unconnected.
 - Example of a recommended circuit:

- Input/Output Equivalent Circuit

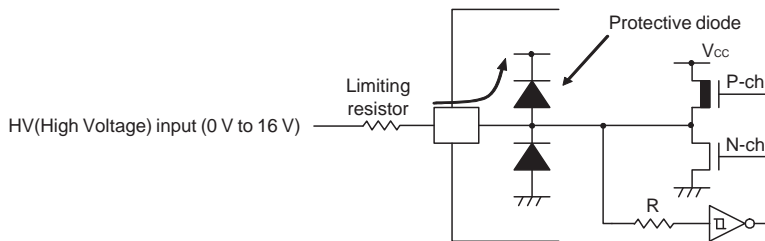

- *4: P62 and P63 are available in MB95F204H/F203H/F202H/F204K/F203K/F202K.

WARNING: A semiconductor device may be damaged by applying stress (voltage, current, temperature, etc.) in excess of the absolute maximum rating. Therefore, ensure that not a single parameter exceeds its absolute maximum rating.

MB95200H/210H Series

2. Recommended Operating Conditions

(V_{SS}=0.0 V)

Parameter	Symbol	Value		Unit	Remarks	
		Min	Max			
Power supply voltage	V _{CC}	2.4*1*2	5.5*1	V	In normal operation	Other than on-chip debug mode
		2.3	5.5		Hold condition in stop mode	
		2.9	5.5		In normal operation	On-chip debug mode
		2.3	5.5		Hold condition in stop mode	
Smoothing capacitor	C _S	0.022	1	μF	*3	
Operating temperature	T _A	-40	+85	°C	Other than on-chip debug function	
		+5	+35		On-chip debug function	

*1: The value varies depending on the operating frequency, the machine clock and the analog guaranteed range.

*2: The value is 2.88 V when the low-voltage detection reset is used.

*3: Use a ceramic capacitor or a capacitor with equivalent frequency characteristics. The bypass capacitor for the V_{CC} pin must have a capacitance larger than C_S. For the connection to a smoothing capacitor C_S, see the diagram below. To prevent the device from unintentionally entering an unknown mode due to noise, minimize the distance between the C pin and C_S and the distance between C_S and the V_{SS} pin when designing the layout of a printed circuit board.

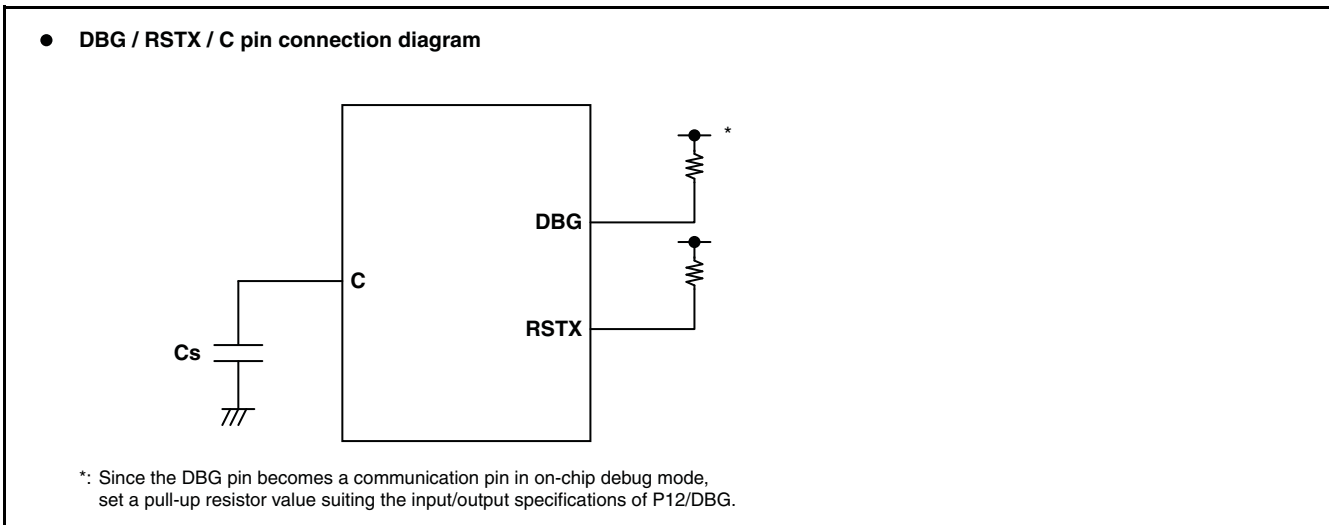

WARNING: The recommended operating conditions are required in order to ensure the normal operation of the semiconductor device. All of the electrical characteristics of the device are warranted when the device is operated within these ranges.

Always use semiconductor devices within their recommended operating condition ranges. Operation outside these ranges may adversely affect reliability and could result in device failure.

No warranty is made with respect to uses, operating conditions, or combinations not represented on the data sheet. Users considering application outside the listed conditions are advised to contact sales representatives beforehand.

MB95200H/210H Series

3. DC Characteristics

($V_{CC} = 5.0\text{ V} \pm 10\%$, $V_{SS} = 0.0\text{ V}$, $T_A = -40^\circ\text{C}$ to $+85^\circ\text{C}$)

Parameter	Symbol	Pin name	Condition	Value			Unit	Remarks
				Min	Typ	Max		
"H" level input voltage	V_{IH1}	P04	*1	$0.7 V_{CC}$	—	$V_{CC}+0.3$	V	When CMOS input level (hysteresis input) is selected
	V_{IHS}	P00 to P07, P12, P62 to P64, PF0 to PF1, PG1 to PG2	*1	$0.8 V_{CC}$	—	$V_{CC}+0.3$	V	Hysteresis input
	V_{IHM}	PF2	—	$0.7 V_{CC}$	—	$V_{CC}+0.3$	V	Hysteresis input
"L" level input voltage	V_{IL}	P04	*1	$V_{SS}-0.3$	—	$0.3 V_{CC}$	V	When CMOS input level (hysteresis input) is selected
	V_{ILS}	P00 to P07, P12, P62 to P64, PF0 to PF1, PG1 to PG2	*1	$V_{SS}-0.3$	—	$0.2 V_{CC}$	V	Hysteresis input
	V_{ILM}	PF2	—	$V_{SS}-0.3$	—	$0.3 V_{CC}$	V	Hysteresis input
Open-drain output application voltage	V_D	PF2, P12	—	$V_{SS}-0.3$	—	$0.2 V_{CC}$	V	
"H" level output voltage	V_{OH1}	Output pins other than P05, P06, P62, P63, PF2 and P12 ²	$I_{OH} = -4\text{ mA}$	$V_{CC}-0.5$	—	—	V	
	V_{OH2}	P05, P06, P62, P63 ²	$I_{OH} = -8\text{ mA}$	$V_{CC}-0.5$	—	—	V	
"L" level output voltage	V_{OL1}	Output pins other than P05, P06, P62 and P63 ²	$I_{OL} = 4\text{ mA}$	—	—	0.4	V	
	V_{OL2}	P05, P06, P62, P63 ²	$I_{OL} = 2\text{ mA}$	—	—	0.4	V	
Input leak current (Hi-Z output leak current)	I_{LI}	All input pins	$0.0\text{ V} < V_i < V_{CC}$	-5	—	+5	μA	When pull-up resistance is disabled
Pull-up resistance	R_{PULL}	P00 to P07, PG1, PG2 ³	$V_i = 0\text{ V}$	25	50	100	k Ω	When pull-up resistance is enabled

(Continued)

MB95200H/210H Series

($V_{CC} = 5.0\text{ V} \pm 10\%$, $V_{SS} = 0.0\text{ V}$, $T_A = -40^\circ\text{C}$ to $+85^\circ\text{C}$)

Parameter	Symbol	Pin name	Condition	Value			Unit	Remarks
				Min	Typ	Max		
Input capacitance	C_{IN}	Other than V_{CC} and V_{SS}	$f = 1\text{ MHz}$	—	5	15	pF	
Power supply current*4	I_{CC}	V_{CC} (External clock operation)	$V_{CC} = 5.5\text{ V}$ $F_{CH} = 32\text{ MHz}$ $F_{MP} = 16\text{ MHz}$ Main clock mode (divided by 2)	—	13	17	mA	Flash memory product (except writing and erasing)
				—	33.5	39.5	mA	Flash memory product (at writing and erasing)
				—	15	21	mA	At A/D conversion
	I_{CCS}		$V_{CC} = 5.5\text{ V}$ $F_{CH} = 32\text{ MHz}$ $F_{MP} = 16\text{ MHz}$ Main sleep mode (divided by 2)	—	5.5	9	mA	
	I_{CCL}		$V_{CC} = 5.5\text{ V}$ $F_{CL} = 32\text{ kHz}$ $F_{MPL} = 16\text{ kHz}$ Subclock mode (divided by 2) $T_A = +25^\circ\text{C}$	—	65	153	μA	
	I_{CCLS}		$V_{CC} = 5.5\text{ V}$ $F_{CL} = 32\text{ kHz}$ $F_{MPL} = 16\text{ kHz}$ Subsleep mode (divided by 2) $T_A = +25^\circ\text{C}$	—	10	84	μA	
I_{CCT}	$V_{CC} = 5.5\text{ V}$ $F_{CL} = 32\text{ kHz}$ Watch mode Main stop mode $T_A = +25^\circ\text{C}$	—	5	30	μA			

(Continued)

MB95200H/210H Series

($V_{CC} = 5.0\text{ V} \pm 10\%$, $V_{SS} = 0.0\text{ V}$, $T_A = -40^\circ\text{C}$ to $+85^\circ\text{C}$)

Parameter	Symbol	Pin name	Condition	Value			Unit	Remarks
				Min	Typ	Max		
Power supply current*4	I _{CCMCR}	V _{CC}	V _{CC} = 5.5 V F _{CRH} = 10 MHz F _{MP} = 10 MHz Main CR clock mode	—	8.6	—	mA	
	I _{CCSCR}		V _{CC} = 5.5 V Sub-CR clock mode (divided by 2) T _A = +25 °C	—	110	410	μA	
	I _{CCTS}	V _{CC} (External clock operation)	V _{CC} = 5.5 V F _{CH} = 32 MHz Timebase timer mode T _A = +25 °C	—	1.1	3	mA	
	I _{CCCH}		V _{CC} = 5.5 V Substop mode T _A = +25 °C	—	3.5	22.5	μA	Main stop mode for single clock selection
	I _{LVD}	V _{CC}	Current consumption for low-voltage detection circuit only	—	37	54	μA	
	I _{CRH}		Current consumption for the internal main CR oscillator	—	0.5	0.6	mA	
	I _{CRL}		Current consumption for the internal sub-CR oscillator oscillating at 100 kHz	—	20	72	μA	

*1: The input level of P04 can be switched between “CMOS input level” and “hysteresis input level”. The input level selection register (ILSR) is used to switch between the two input levels.

*2: P62 and P63 are available in MB95F204H/F203H/F202H/F204K/F203K/F202K.

*3: P00 to P03, P07, PG1 and PG2 are available in MB95F204H/F203H/F202H/F204K/F203K/F202K.

(Continued)

MB95200H/210H Series

(Continued)

- *4: • The power supply current is determined by the external clock. When the low-voltage detection option is selected, the power-supply current will be the sum of adding the current consumption of the low-voltage detection circuit (I_{LVD}) to a specified value. In addition, when both the low-voltage detection option and the internal CR oscillator are selected, the power supply current will be the sum of adding up the current consumption of the low-voltage detection circuit, the current consumption of the internal CR oscillators (I_{CRH} , I_{CRL}) and a specified value. In on-chip debug mode, the internal CR oscillator (I_{CRH}) and the low-voltage detection circuit are always enabled, and current consumption therefore increases accordingly.
- See "4. AC Characteristics: (1) Clock Timing" for F_{CH} and F_{CL} .
- See "4. AC Characteristics: (2) Source Clock/Machine Clock" for F_{MP} and F_{MPL} .

MB95200H/210H Series

4. AC Characteristics

(1) Clock Timing

($V_{CC} = 2.4\text{ V to }5.5\text{ V}$, $V_{SS} = 0.0\text{ V}$, $T_A = -40^\circ\text{C to }+85^\circ\text{C}$)

Parameter	Symbol	Pin name	Condition	Value			Unit	Remarks					
				Min	Typ	Max							
Clock frequency	F _{CH}	X0, X1	—	1	—	16.25	MHz	When the main oscillation circuit is used					
		X0, HCLK1, HCLK2	X1 open	1	—	12	MHz	When the main external clock is used					
		X0, X1, HCLK1, HCLK2	—	1	—	32.5	MHz						
	F _{CRH}	—	—	—	9.7	10	10.3	MHz	When the main internal clock is used 3.3 V ≤ V _{CC} ≤ 5.5 V (-40 °C ≤ T _A ≤ 40 °C) 2.4 V ≤ V _{CC} < 3.3 V (0 °C ≤ T _A ≤ 40 °C)				
					7.76	8	8.24	MHz					
					0.97	1	1.03	MHz					
					F _{CRH}	—	—	—	9.55	10	10.45	MHz	When the main internal clock is used 3.3 V ≤ V _{CC} ≤ 5.5 V (40 °C < T _A ≤ 85 °C)
									7.64	8	8.36	MHz	
									0.955	1	1.045	MHz	
									9.5	10	10.5	MHz	When the main internal clock is used 2.4 V ≤ V _{CC} < 3.3 V (-40 °C ≤ T _A < 0 °C, 40 °C < T _A ≤ 85 °C)
									7.6	8	8.4	MHz	
									0.95	1	1.05	MHz	
	F _{CL}	X0A, X1A	—	—	—	32.768	—	kHz	When the main oscillation circuit is used				
—					32.768	—	kHz	When the sub-external clock is used					
F _{CRL}	—	—	—	50	100	200	kHz	When the sub-internal CR clock is used					
Clock cycle time	t _{HCYL}	X0, X1	—	61.5	—	1000	ns	When the main oscillation circuit is used					
		X0, HCLK1, HCLK2	X1 open	83.4	—	1000	ns	When the external clock is used					
		X0, X1, HCLK1, HCLK2	—	30.8	—	1000	ns						
	t _{LCYL}	X0A, X1A	—	—	30.5	—	μs	When the subclock is used					

(Continued)

MB95200H/210H Series

(Continued)

($V_{CC} = 2.4\text{ V to }5.5\text{ V}$, $V_{SS} = 0.0\text{ V}$, $T_A = -40^\circ\text{C to }+85^\circ\text{C}$)

Parameter	Symbol	Pin name	Condition	Value			Unit	Remarks
				Min	Typ	Max		
Input clock pulse width	t_{WH1}	X0, HCLK1, HCLK2	X1 open	33.4	—	—	ns	When the external clock is used, the duty ratio should range between 40% and 60%.
	t_{WL1}	X0, X1, HCLK1, HCLK2	—	12.4	—	—	ns	
	t_{WH2} t_{WL2}	X0A	—	—	15.2	—	μs	
Input clock rise time and fall time	t_{CR}	X0, HCLK1, HCLK2	X1 open	—	—	5	ns	When the external clock is used
	t_{CF}	X0, X1, HCLK1, HCLK2	—	—	—	5	ns	
Internal CR oscillation start time	t_{CRHWK}	—	—	—	—	80	μs	When the main internal CR clock is used
	t_{CRLWK}	—	—	—	—	10	μs	When the sub-internal CR clock is used

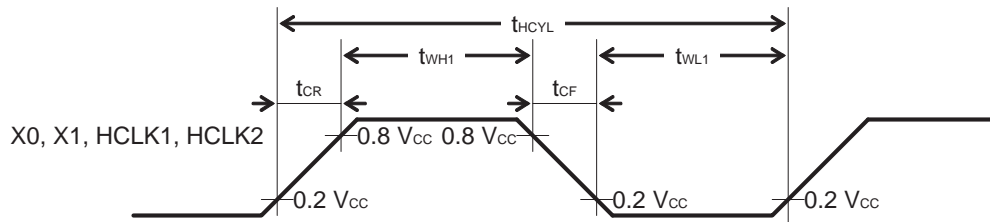

- Figure of main clock input port external connection

When a crystal oscillator or a ceramic oscillator is used

When the external clock is used (X1 is open)

When the external clock is used

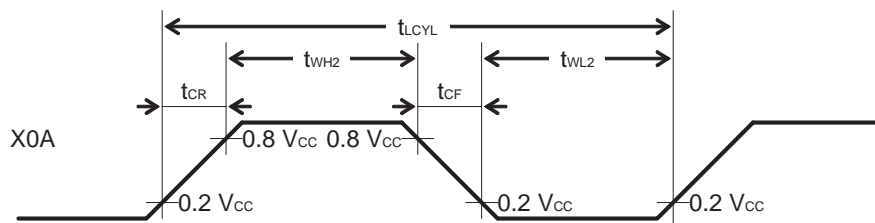
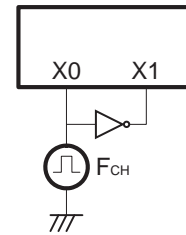
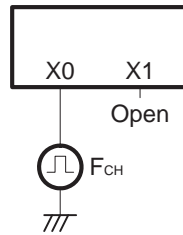
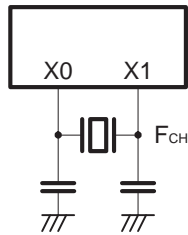

- Figure of subclock input port external connection

When a crystal oscillator or a ceramic oscillator is used

When the external clock is used

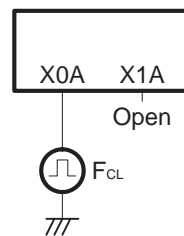
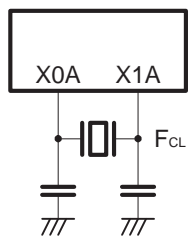

MB95200H/210H Series

(2) Source Clock/Machine Clock

($V_{CC} = 5.0 V \pm 10\%$, $V_{SS} = 0.0 V$, $T_A = -40^\circ C$ to $+85^\circ C$)

Parameter	Symbol	Pin name	Value			Unit	Remarks
			Min	Typ	Max		
Source clock cycle time*1 (clock before division)	t _{SCLK}	—	61.5	—	2000	ns	When the main external clock is used Min: F _{CH} = 32.5 MHz, divided by 2 Max: F _{CH} = 1 MHz, divided by 2
			100	—	1000	ns	When the main CR clock is used Min: F _{CRH} = 10 MHz Max: F _{CRH} = 1 MHz
			—	61	—	μs	When the sub-oscillation clock is used F _{CL} = 32.768 kHz, divided by 2
			—	20	—	μs	When the sub-oscillation clock is used F _{CRL} = 100 kHz, divided by 2
Source clock frequency	F _{SP}	—	0.5	—	16.25	MHz	When the main oscillation clock is used
			1	—	10	MHz	When the main CR clock is used
	—		16.384	—	kHz	When the sub-oscillation clock is used	
	—		50	—	kHz	When the sub-CR clock is used F _{CRL} = 100 kHz, divided by 2	
Machine clock cycle time*2 (minimum instruction execution time)	t _{MCLK}	—	61.5	—	32000	ns	When the main oscillation clock is used Min: F _{SP} = 16.25 MHz, no division Max: F _{SP} = 0.5 MHz, divided by 16
			100	—	16000	ns	When the main CR clock is used Min: F _{SP} = 10 MHz Max: F _{SP} = 1 MHz, divided by 16
			61	—	976.5	μs	When the sub-oscillation clock is used Min: F _{SPL} = 16.384 kHz, no division Max: F _{SPL} = 16.384 kHz, divided by 16
			20	—	320	μs	When the sub-CR clock is used Min: F _{SPL} = 50 kHz, no division Max: F _{SPL} = 50 kHz, divided by 16
Machine clock frequency	F _{MP}	—	0.031	—	16.25	MHz	When the main oscillation clock is used
			0.0625	—	10	MHz	When the main CR clock is used
	1.024		—	16.384	kHz	When the sub-oscillation clock is used	
	3.125		—	50	kHz	When the sub-CR clock is used F _{CRL} = 100 kHz	

*1: This is the clock before it is divided according to the division ratio set by the machine clock division ratio selection bits (SYCC : DIV1 and DIV0) . This source clock is divided to become a machine clock according to the division ratio set by the machine clock division ratio selection bits (SYCC : DIV1 and DIV0) . In addition, a source clock can be selected from the following.

- Main clock divided by 2
- Main CR clock
- Subclock divided by 2
- Sub-CR clock divided by 2

(Continued)

(Continued)

*2: This is the operating clock of the microcontroller. A machine clock can be selected from the following.

- Source clock (no division)
- Source clock divided by 4
- Source clock divided by 8
- Source clock divided by 16

MB95200H/210H Series

- Schematic diagram of the clock generation block

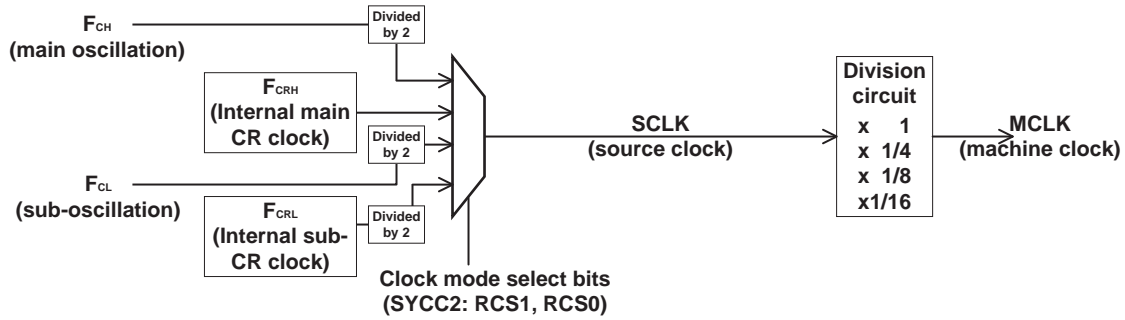

- Operating voltage - Operating frequency (When $T_A = -40^\circ\text{C}$ to $+85^\circ\text{C}$)
 - MB95200H/210H (without the on-chip debug function)

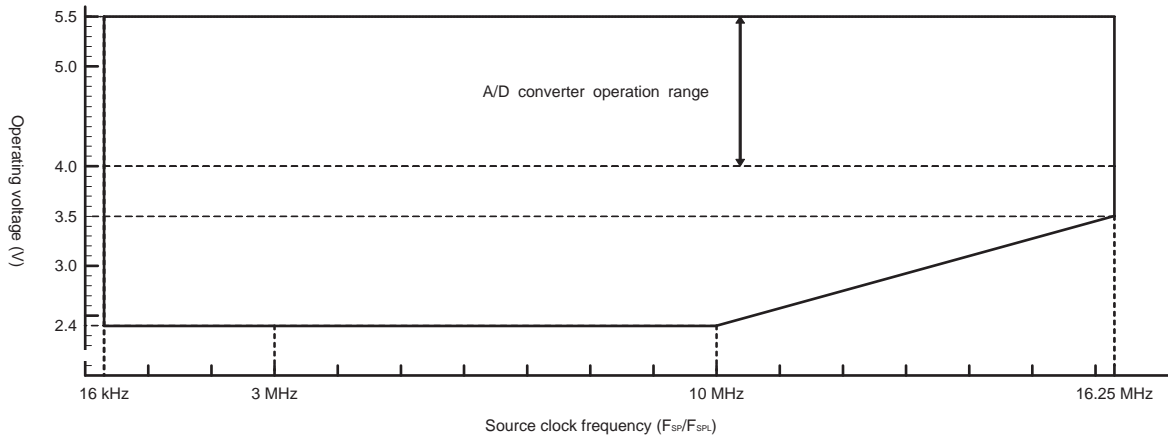

- Operating voltage - Operating frequency (When $T_A = +5^\circ\text{C}$ to $+35^\circ\text{C}$)
 - MB95200H/210H (with the on-chip debug function)

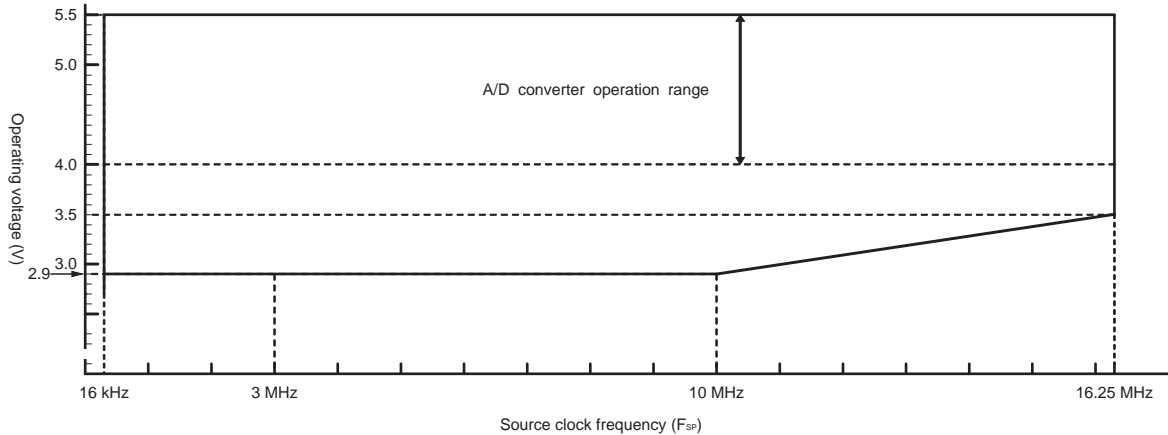

(3) External Reset

($V_{CC} = 5.0 V \pm 10\%$, $V_{SS} = 0.0 V$, $T_A = -40^\circ C$ to $+85^\circ C$)

Parameter	Symbol	Value		Unit	Remarks
		Min	Max		
RSTX "L" level pulse width	t_{RSTL}	$2 t_{MCLK}^{*1}$	—	ns	In normal operation
		Oscillation time of the oscillator ^{*2} +100	—	μs	In stop mode, subclock mode, sub-sleep mode, and watch mode
		100	—	μs	In timebase timer mode

*1: See "(2) Source Clock/Machine Clock" for t_{MCLK} .

*2: The oscillation time of an oscillator is the time that the amplitude reaches 90%. The crystal oscillator has an oscillation time of between several ms and tens of ms. The ceramic oscillator has an oscillation time of between hundreds of μs and several ms. The external clock has an oscillation time of 0 ms. The CR oscillator clock has an oscillation time of between several μs and several ms.

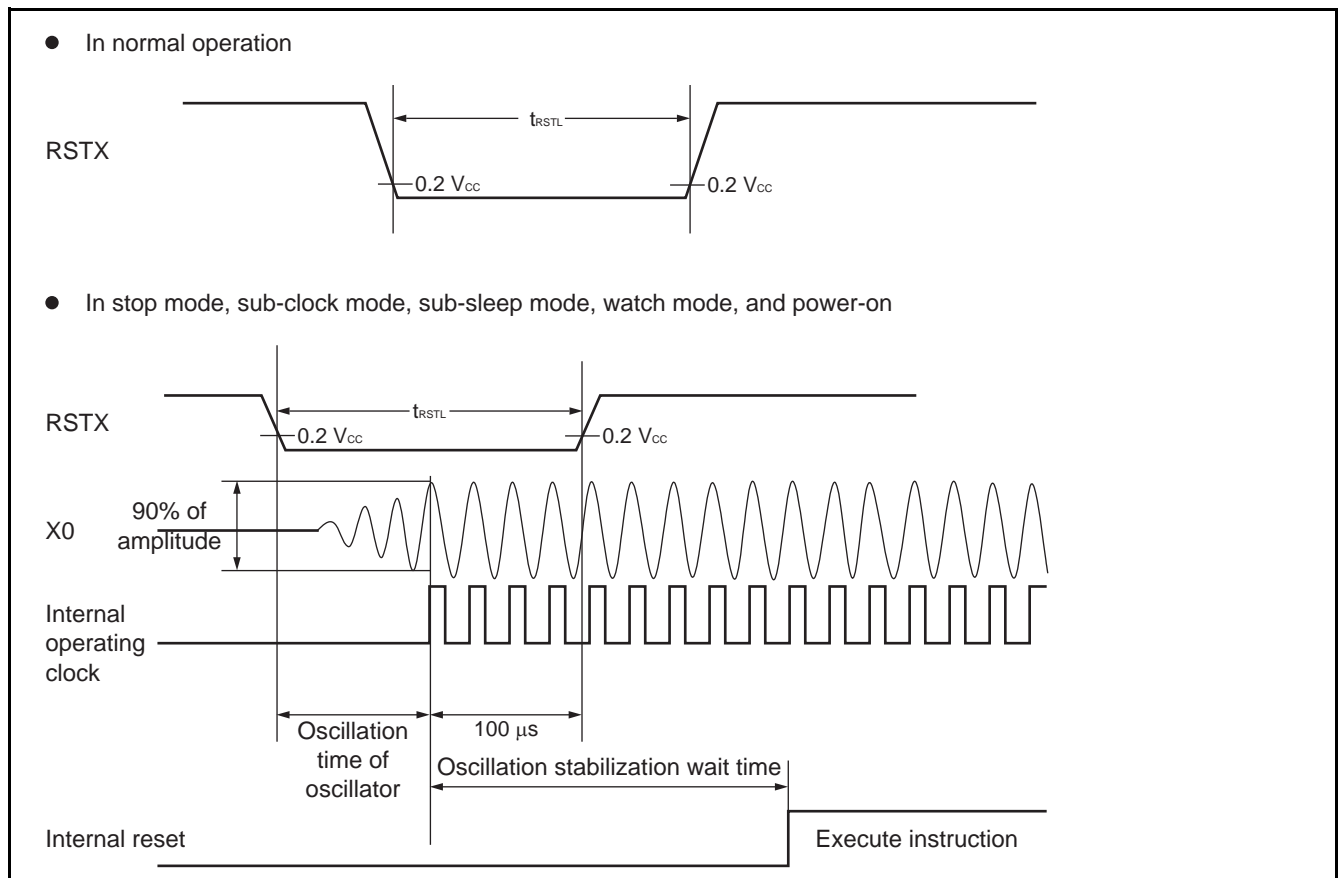

MB95200H/210H Series

(4) Power-on Reset

($V_{SS} = 0.0\text{ V}$, $T_A = -40^\circ\text{C}$ to $+85^\circ\text{C}$)

Parameter	Symbol	Condition	Value		Unit	Remarks
			Min	Max		
Power supply rising time	t_R	—	—	50	ms	
Power supply cutoff time	t_{OFF}	—	1	—	ms	Wait time until power-on

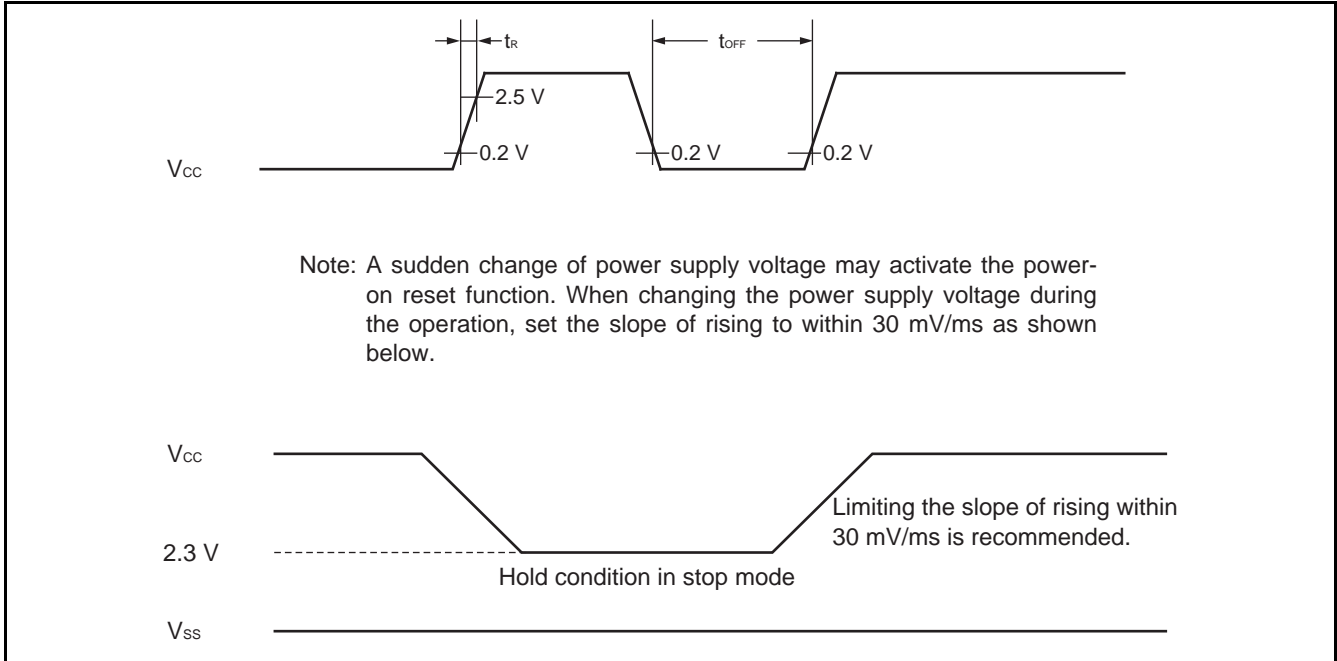

(5) Peripheral Input Timing

($V_{CC} = 5.0\text{ V} \pm 10\%$, $V_{SS} = 0.0\text{ V}$, $T_A = -40^\circ\text{C}$ to $+85^\circ\text{C}$)

Parameter	Symbol	Pin name	Value		Unit
			Min	Max	
Peripheral input "H" pulse width	t_{LH}	INT02 to INT07, EC0, EC1 ^{*2}	$2 t_{MCLK}^{*1}$	—	ns
Peripheral input "L" pulse width	t_{HL}		$2 t_{MCLK}^{*1}$	—	ns

*1: See "(2) Source Clock/Machine Clock" for t_{MCLK} .

*2: INT02, INT03, INT05, INT07 and EC1 are available in MB95F204H/F203H/F202H/F204K/F203K/F202K.

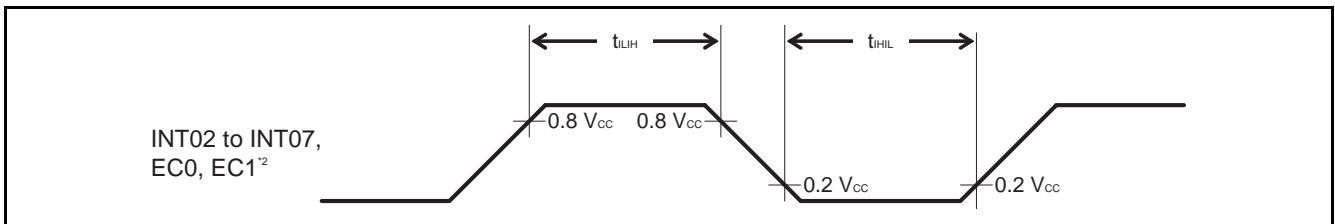

MB95200H/210H Series

(6) LIN-UART Timing (Available in MB95F204H/F203H/F202H/F204K/F203K/F202K only)

Sampling is executed at the rising edge of the sampling clock*¹, and serial clock delay is disabled*².
(ESCR register : SCES bit = 0, ECCR register : SCDE bit = 0)

(V_{CC} = 5.0 V±10%, AV_{SS} = V_{SS} = 0.0 V, T_A = -40°C to +85°C)

Parameter	Symbol	Pin name	Condition	Value		Unit
				Min	Max	
Serial clock cycle time	t _{SCYC}	SCK	Internal clock operation output pin: C _L = 80 pF+1 TTL	5 t _{MCLK} * ³	—	ns
SCK ↓→ SOT delay time	t _{SLOVI}	SCK, SOT		-95	+95	ns
Valid SIN → SCK ↑	t _{IVSHI}	SCK, SIN		t _{MCLK} * ³ +190	—	ns
SCK ↑→ valid SIN hold time	t _{SHIXI}	SCK, SIN		0	—	ns
Serial clock “L” pulse width	t _{SLSH}	SCK	External clock operation output pin: C _L = 80 pF+1 TTL	3 t _{MCLK} * ³ -t _R	—	ns
Serial clock “H” pulse width	t _{SHSL}	SCK		t _{MCLK} * ³ +95	—	ns
SCK ↓→ SOT delay time	t _{SLOVE}	SCK, SOT		—	2 t _{MCLK} * ³ +95	ns
Valid SIN → SCK ↑	t _{IVSHE}	SCK, SIN		190	—	ns
SCK ↑→ valid SIN hold time	t _{SHIXE}	SCK, SIN		t _{MCLK} * ³ +95	—	ns
SCK fall time	t _F	SCK		—	10	ns
SCK rise time	t _R	SCK		—	10	ns

*1: There is a function used to choose whether the sampling of reception data is performed at a rising edge or a falling edge of the serial clock.

*2: The serial clock delay function is a function used to delay the output signal of the serial clock for half the clock.

*3: See “(2) Source Clock/Machine Clock” for t_{MCLK}.

● Internal shift clock mode

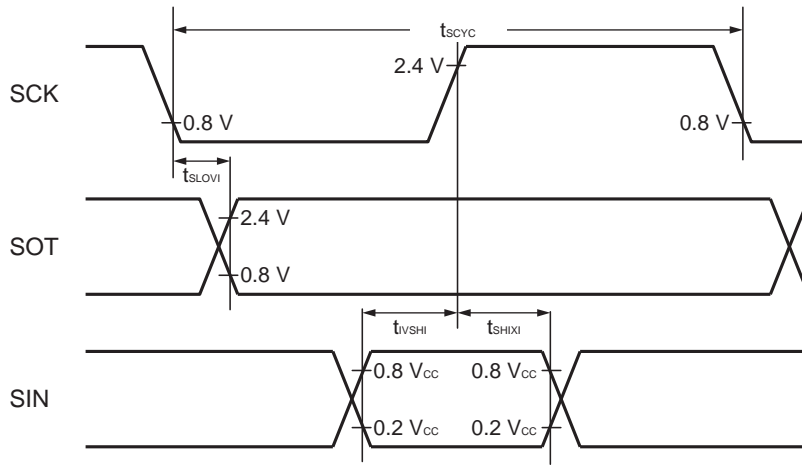

● External shift clock mode

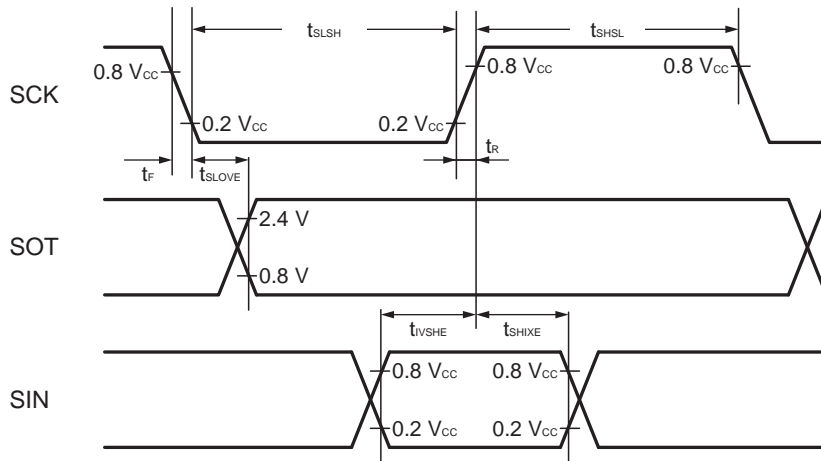

MB95200H/210H Series

Sampling is executed at the falling edge of the sampling clock*1, and serial clock delay is disabled*2.
(ESCR register : SCES bit = 1, ECCR register : SCDE bit = 0)

($V_{CC} = 5.0 V \pm 10\%$, $V_{SS} = 0.0 V$, $T_A = -40^\circ C$ to $+85^\circ C$)

Parameter	Symbol	Pin name	Condition	Value		Unit
				Min	Max	
Serial clock cycle time	t_{SCYC}	SCK	Internal clock operation output pin: $C_L = 80 \text{ pF} + 1 \text{ TTL}$	$5 t_{MCLK}^{*3}$	—	ns
SCK $\uparrow \rightarrow$ SOT delay time	t_{SHOVI}	SCK, SOT		-95	+95	ns
Valid SIN \rightarrow SCK \downarrow	t_{IVSLI}	SCK, SIN		$t_{MCLK}^{*3} + 190$	—	ns
SCK $\downarrow \rightarrow$ valid SIN hold time	t_{SLIXI}	SCK, SIN		0	—	ns
Serial clock "H" pulse width	t_{SHSL}	SCK	External clock operation output pin: $C_L = 80 \text{ pF} + 1 \text{ TTL}$	$3 t_{MCLK}^{*3} - t_R$	—	ns
Serial clock "L" pulse width	t_{SLSH}	SCK		$t_{MCLK}^{*3} + 95$	—	ns
SCK $\uparrow \rightarrow$ SOT delay time	t_{SHOVE}	SCK, SOT		—	$2 t_{MCLK}^{*3} + 95$	ns
Valid SIN \rightarrow SCK \downarrow	t_{IVSLE}	SCK, SIN		190	—	ns
SCK $\downarrow \rightarrow$ valid SIN hold time	t_{SLIXE}	SCK, SIN		$t_{MCLK}^{*3} + 95$	—	ns
SCK fall time	t_F	SCK		—	10	ns
SCK rise time	t_R	SCK		—	10	ns

*1: There is a function used to choose whether the sampling of reception data is performed at a rising edge or a falling edge of the serial clock.

*2: The serial clock delay function is a function used to delay the output signal of the serial clock for half the clock.

*3: See "(2) Source Clock/Machine Clock" for t_{MCLK} .

● Internal shift clock mode

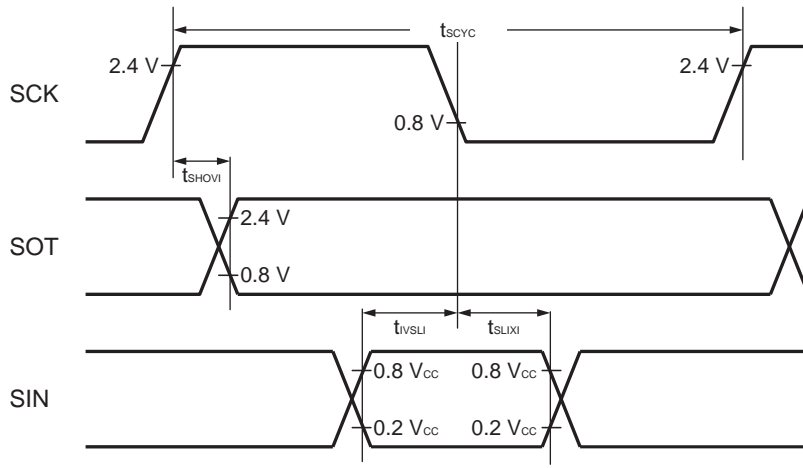

● External shift clock mode

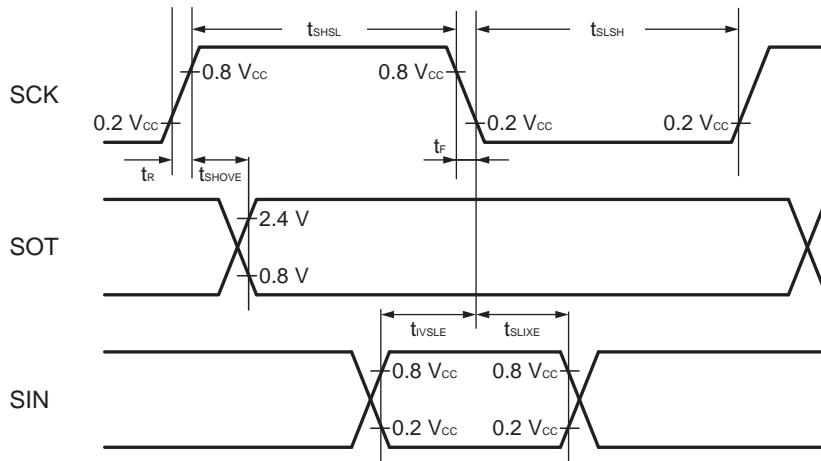

MB95200H/210H Series

Sampling is executed at the rising edge of the sampling clock*¹, and serial clock delay is enabled*².
 (ESCR register : SCES bit = 0, ECCR register : SCDE bit = 1)

($V_{CC} = 5.0\text{ V} \pm 10\%$, $V_{SS} = 0.0\text{ V}$, $T_A = -40^\circ\text{C}$ to $+85^\circ\text{C}$)

Parameter	Symbol	Pin name	Condition	Value		Unit
				Min	Max	
Serial clock cycle time	t_{SCYC}	SCK	Internal clock operation output pin: $C_L = 80\text{ pF} + 1\text{ TTL}$	$5 t_{MCLK}^{*3}$	—	ns
SCK $\uparrow \rightarrow$ SOT delay time	t_{SHOVI}	SCK, SOT		-95	+95	ns
Valid SIN \rightarrow SCK \downarrow	t_{IVSLI}	SCK, SIN		$t_{MCLK}^{*3} + 190$	—	ns
SCK $\downarrow \rightarrow$ valid SIN hold time	t_{SLIXI}	SCK, SIN		0	—	ns
SOT \rightarrow SCK \downarrow delay time	t_{SOVLI}	SCK, SOT		—	$4 t_{MCLK}^{*3}$	ns

*1: There is a function used to choose whether the sampling of reception data is performed at a rising edge or a falling edge of the serial clock.

*2: The serial clock delay function is a function that delays the output signal of the serial clock for half clock.

*3: See "(2) Source Clock/Machine Clock" for t_{MCLK} .

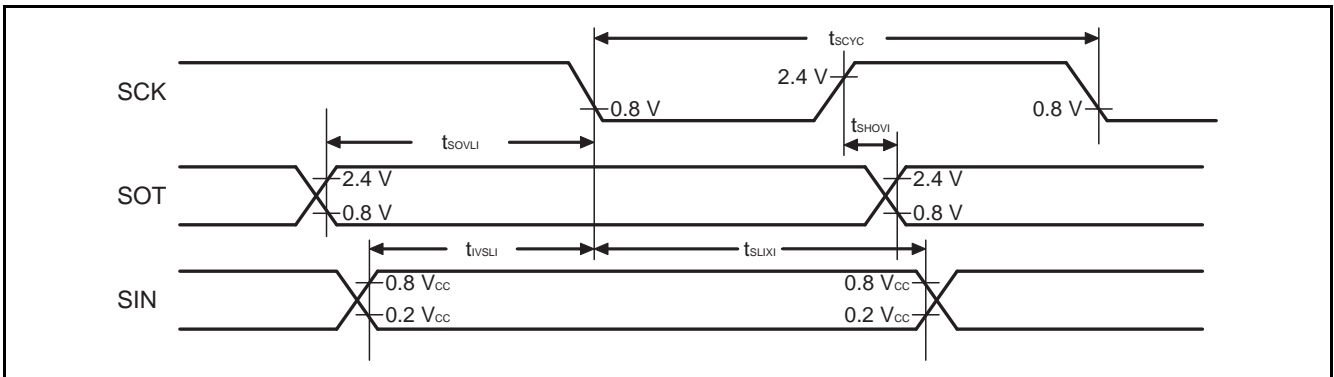

MB95200H/210H Series

Sampling is executed at the falling edge of the sampling clock*¹, and serial clock delay is enabled*².
 (ESCR register : SCES bit = 1, ECCR register : SCDE bit = 1)

($V_{CC} = 5.0\text{ V} \pm 10\%$, $V_{SS} = 0.0\text{ V}$, $T_A = -40^\circ\text{C}$ to $+85^\circ\text{C}$)

Parameter	Symbol	Pin name	Condition	Value		Unit
				Min	Max	
Serial clock cycle time	t_{SCYC}	SCK	Internal clock operation output pin: $C_L = 80\text{ pF} + 1\text{ TTL}$	$5 t_{MCLK}^{*3}$	—	ns
SCK ↓ → SOT delay time	t_{SLOVI}	SCK, SOT		-95	+95	ns
Valid SIN → SCK ↑	t_{VSHI}	SCK, SIN		$t_{MCLK}^{*3} + 190$	—	ns
SCK ↑ → valid SIN hold time	t_{SHIXI}	SCK, SIN		0	—	ns
SOT → SCK ↑ delay time	t_{SOVHI}	SCK, SOT		—	$4 t_{MCLK}^{*3}$	ns

*1: There is a function used to choose whether the sampling of reception data is performed at a rising edge or a falling edge of the serial clock.

*2: The serial clock delay function is a function that delays the output signal of the serial clock for half clock.

*3: See “(2) Source Clock/Machine Clock” for t_{MCLK} .

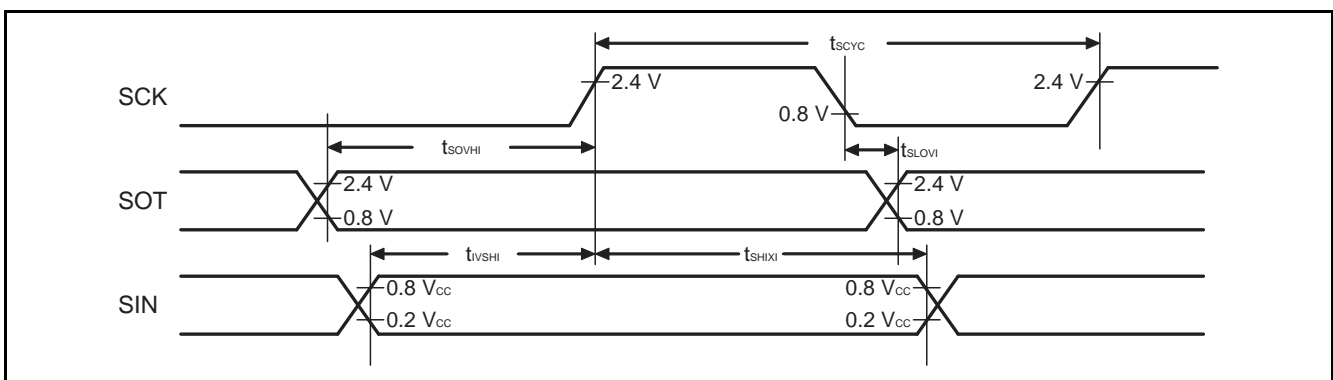

MB95200H/210H Series

(7) Low-voltage Detection

($V_{SS} = 0.0\text{ V}$, $T_A = -40^\circ\text{C}$ to $+85^\circ\text{C}$)

Parameter	Symbol	Value			Unit	Remarks
		Min	Typ	Max		
Release voltage	V_{DL+}	2.52	2.7	2.88	V	At power supply rise
Detection voltage	V_{DL-}	2.42	2.6	2.78	V	At power supply fall
Hysteresis width	V_{HYS}	70	100	—	mV	
Power supply start voltage	V_{off}	—	—	2.3	V	
Power supply end voltage	V_{on}	4.9	—	—	V	
Power supply voltage change time (at power supply rise)	t_r	1	—	—	μs	Slope of power supply that the reset release signal generates
		—	3000	—	μs	Slope of power supply that the reset release signal generates within the rating (V_{DL+})
Power supply voltage change time (at power supply fall)	t_r	300	—	—	μs	Slope of power supply that the reset detection signal generates
		—	300	—	μs	Slope of power supply that the reset detection signal generates within the rating (V_{DL-})
Reset release delay time	t_{d1}	—	—	300	μs	
Reset detection delay time	t_{d2}	—	—	20	μs	

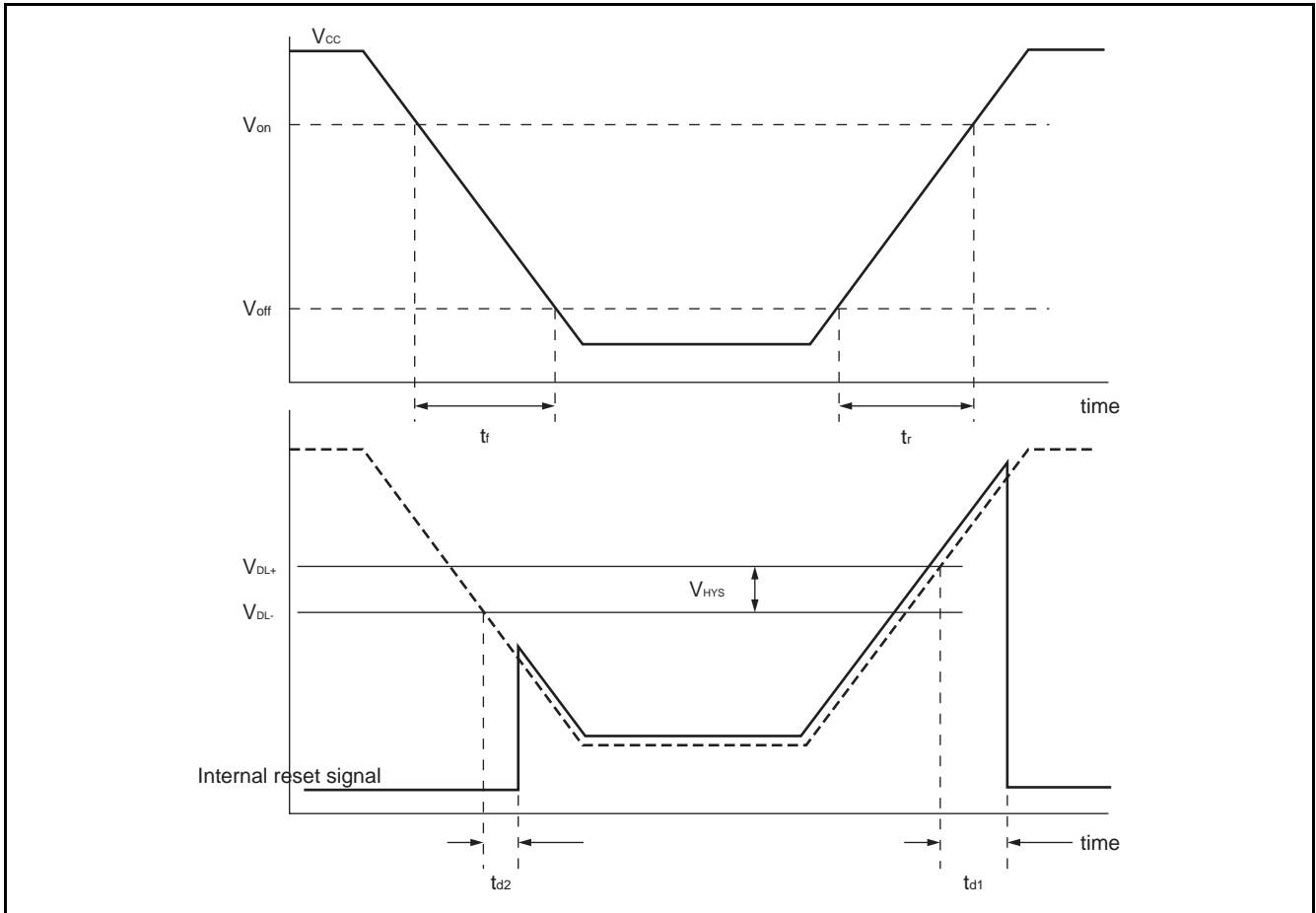

MB95200H/210H Series

5. A/D Converter

(1) A/D Converter Electrical Characteristics

($V_{CC} = 4.0\text{ V to }5.5\text{ V}$, $V_{SS} = 0.0\text{ V}$, $T_A = -40^\circ\text{C to }+85^\circ\text{C}$)

Parameter	Symbol	Value			Unit	Remarks
		Min	Typ	Max		
Resolution	—	—	—	10	bit	
Total error		-3	—	+3	LSB	
Linearity error		-2.5	—	+2.5	LSB	
Differential linear error		-1.9	—	+1.9	LSB	
Zero transition voltage	V_{OT}	$V_{SS}-1.5\text{ LSB}$	$V_{SS}+0.5\text{ LSB}$	$V_{SS}+2.5\text{ LSB}$	V	
Full-scale transition voltage	V_{FST}	$V_{CC}-4.5\text{ LSB}$	$V_{CC}-2\text{ LSB}$	$V_{CC}+0.5\text{ LSB}$	V	
Compare time	—	0.9	—	16500	μs	$4.5\text{ V} \leq V_{CC} \leq 5.5\text{ V}$
		1.8	—	16500	μs	$4.0\text{ V} \leq V_{CC} < 4.5\text{ V}$
Sampling time	—	0.6	—	∞	μs	$4.5\text{ V} \leq V_{CC} \leq 5.5\text{ V}$, with external impedance $< 5.4\text{ k}\Omega$
		1.2	—	∞	μs	$4.0\text{ V} \leq V_{CC} \leq 4.5\text{ V}$, with external impedance $< 2.4\text{ k}\Omega$
Analog input current	I_{AIN}	-0.3	—	+0.3	μA	
Analog input voltage	V_{AIN}	V_{SS}	—	V_{CC}	V	

(2) Notes on Using the A/D Converter

• External impedance of analog input and its sampling time

- The A/D converter has a sample and hold circuit. If the external impedance is too high to keep sufficient sampling time, the analog voltage charged to the internal sample and hold capacitor is insufficient, adversely affecting A/D conversion precision. Therefore, to satisfy the A/D conversion precision standard, considering the relationship between the external impedance and minimum sampling time, either adjust the register value and operating frequency or decrease the external impedance so that the sampling time is longer than the minimum value. In addition, if sufficient sampling time cannot be secured, connect a capacitor of about 0.1 μF to the analog input pin.

• Analog input equivalent circuit

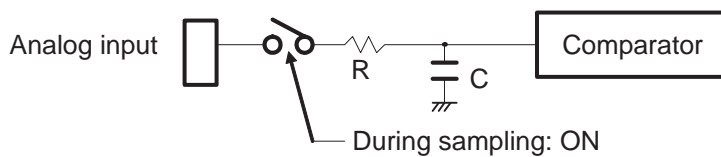

$$4.5 \text{ V} \leq V_{\text{CC}} \leq 5.5 \text{ V} : R \approx 1.95 \text{ k}\Omega \text{ (max)}, C \approx 17 \text{ pF (max)}$$

$$4.0 \text{ V} \leq V_{\text{CC}} < 4.5 \text{ V} : R \approx 8.98 \text{ k}\Omega \text{ (max)}, C \approx 17 \text{ pF (max)}$$

Note: The values are reference values.

• Relationship between external impedance and minimum sampling time

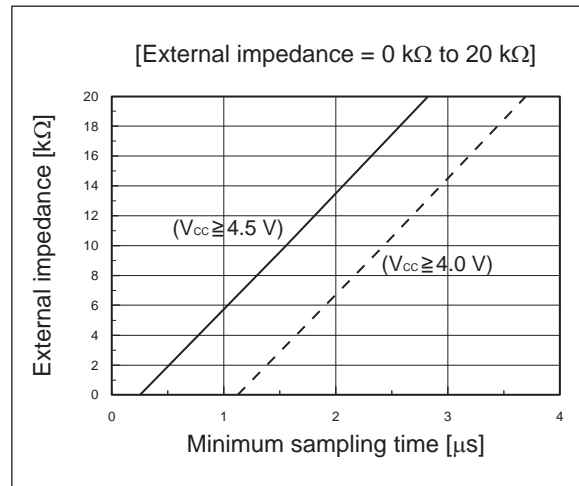
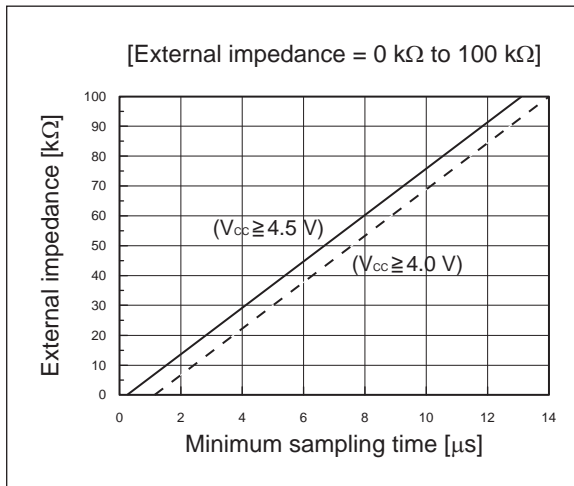

• A/D conversion error

As $V_{\text{CC}} - V_{\text{SS1}}$ decreases, the A/D conversion error increases proportionately.

(3) Definitions of A/D Converter Terms

- Resolution
It indicates the level of analog variation that can be distinguished by the A/D converter.
When the number of bits is 10, analog voltage can be divided into $2^{10} = 1024$.
- Linearity error (unit: LSB)
It indicates how much an actual conversion value deviates from the straight line connecting the zero transition point ("00 0000 0000" \leftrightarrow "00 0000 0001") of a device to the full-scale transition point ("11 1111 1111" \leftrightarrow "11 1111 1110") of the same device.
- Differential linear error (unit: LSB)
It indicates how much the input voltage required to change the output code by 1 LSB deviates from an ideal value.
- Total error (unit: LSB)
It indicates the difference between an actual value and a theoretical value. The error can be caused by a zero transition error, a full-scale transition errors, a linearity error, a quantum error, or noise.

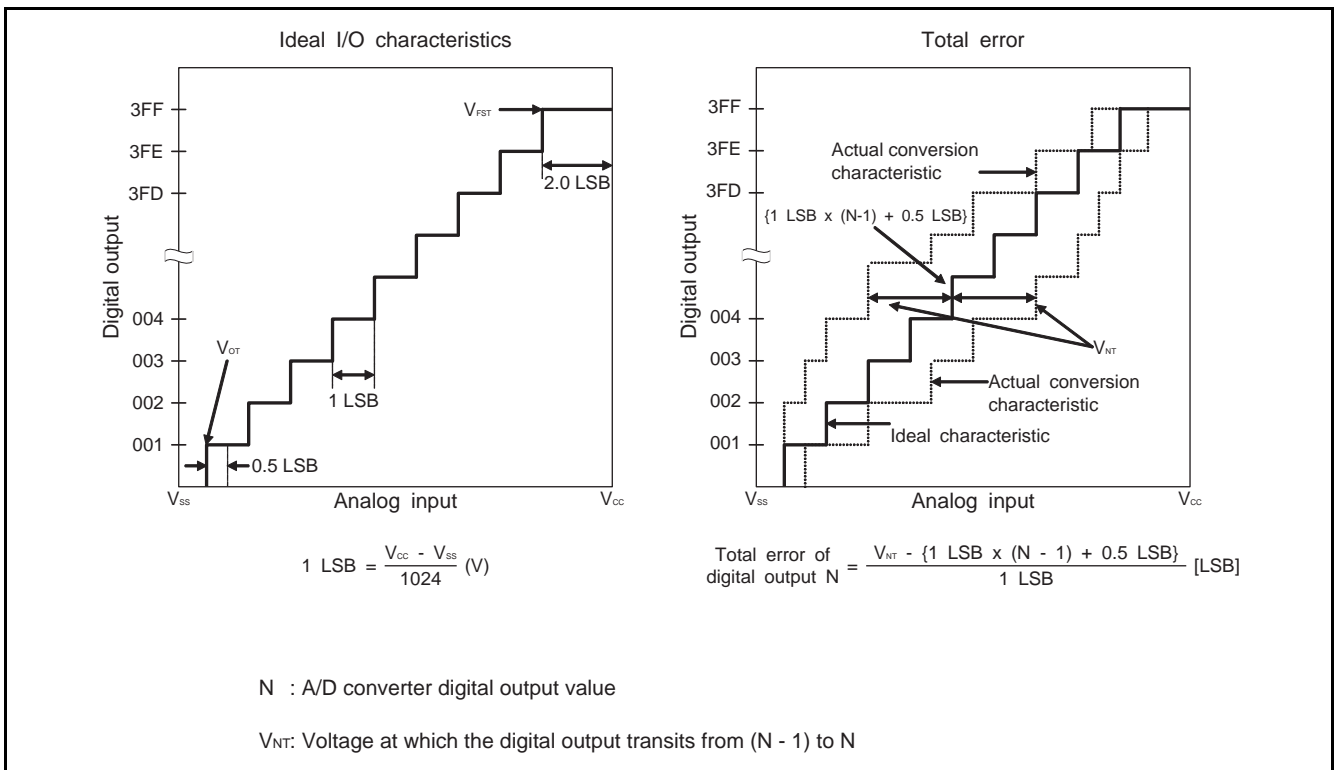

(Continued)

(Continued)

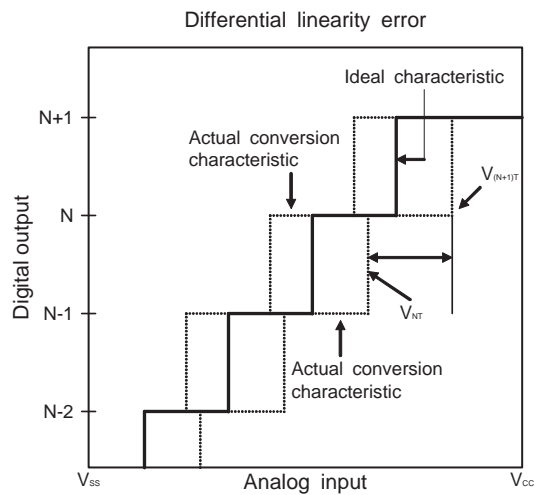
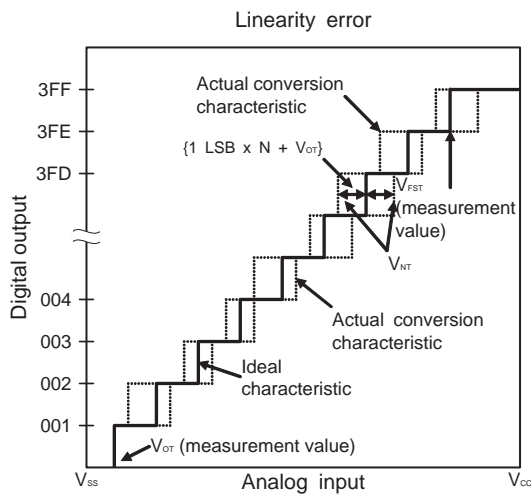
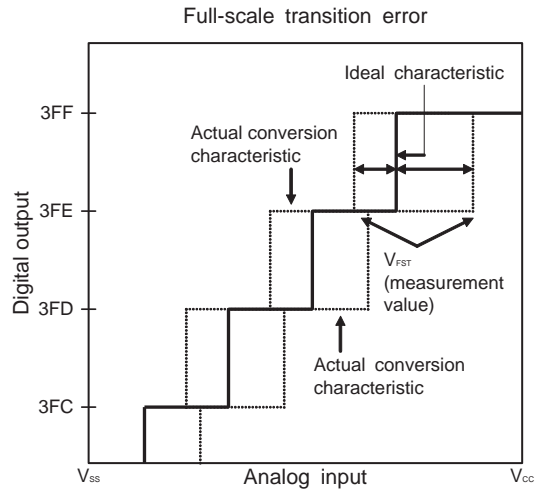
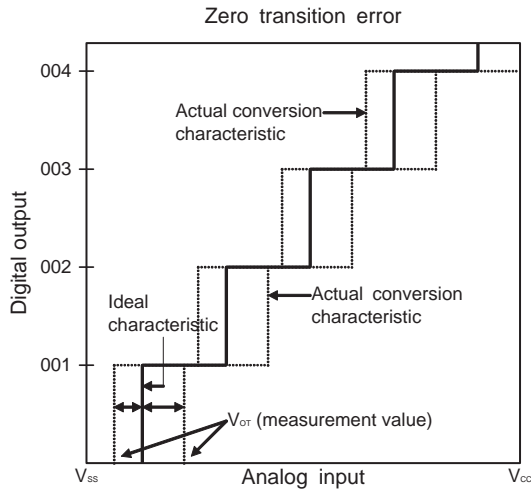

$$\text{Linearity error of digital output } N = \frac{V_{NT} - \{1 \text{ LSB} \times N + V_{OT}\}}{1 \text{ LSB}}$$

$$\text{Differential linear error of digital output } N = \frac{V_{(N+1)T} - V_{NT}}{1 \text{ LSB}} - 1$$

N : A/D converter digital output value

V_{NT} : Voltage at which the digital output transits from (N - 1) to N

V_{OT} (ideal value) = $V_{SS} + 0.5 \text{ LSB}$ [V]

V_{FST} (ideal value) = $V_{CC} - 2.0 \text{ LSB}$ [V]

MB95200H/210H Series

6. Flash Memory Program/Erase Characteristics

Parameter	Value			Unit	Remarks
	Min	Typ	Max		
Chip erase time	—	1*1	15*2	s	00H programming time prior to erasure is excluded.
Byte programming time	—	32	3600	μs	System-level overhead is excluded.
Erase/program voltage	9.5	10	10.5	V	The erase/program voltage must be applied to the RSTX pin in erase/program.
Erase/program cycle	—	100000	—	cycle	
Power supply voltage at erase/program	4.5	—	5.5	V	
Flash memory data retention time	20*3	—	—	year	Average T _A = +85°C

*1: T_A = +25°C, V_{CC} = 5.0 V, 100000 cycles

*2: T_A = +85°C, V_{CC} = 4.5 V, 100000 cycles

*3: This value is converted from the result of a technology reliability assessment. (The value is converted from the result of a high temperature accelerated test by using the Arrhenius equation with the average temperature being +85°C).

■ SAMPLE ELECTRICAL CHARACTERISTICS

- Power supply current • temperature

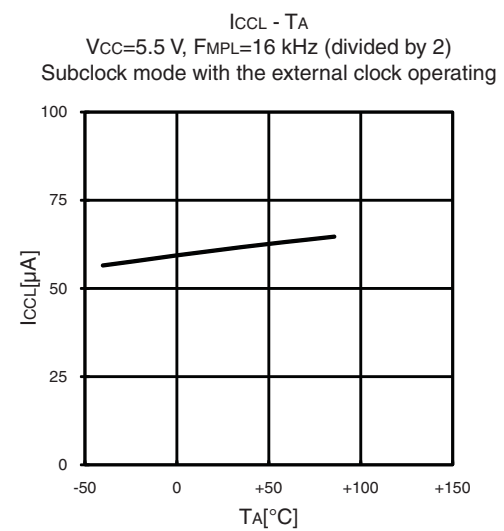
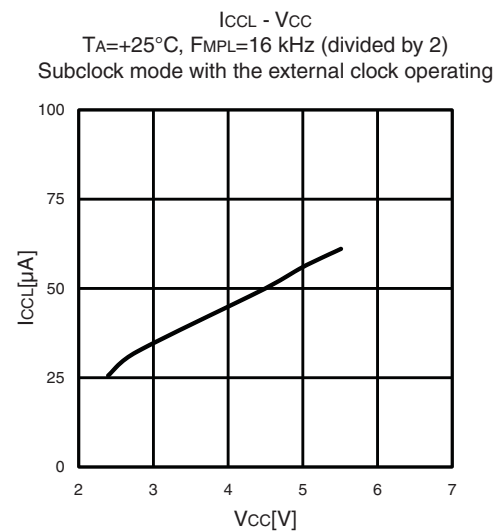
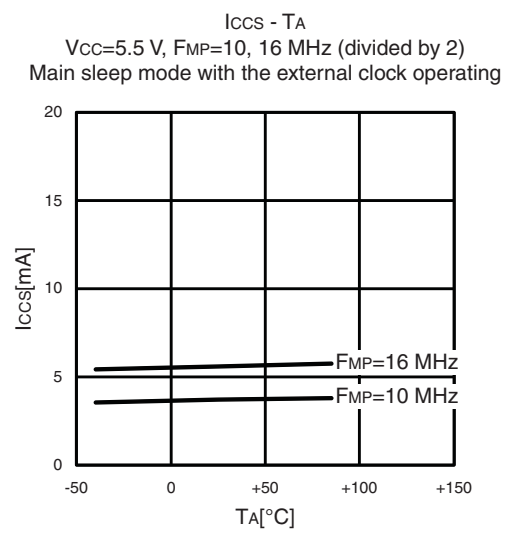
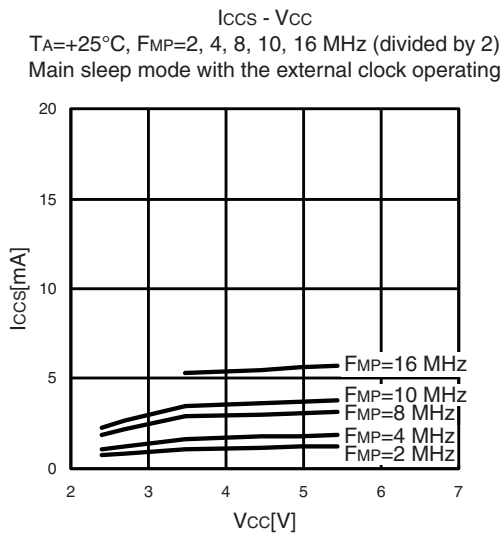
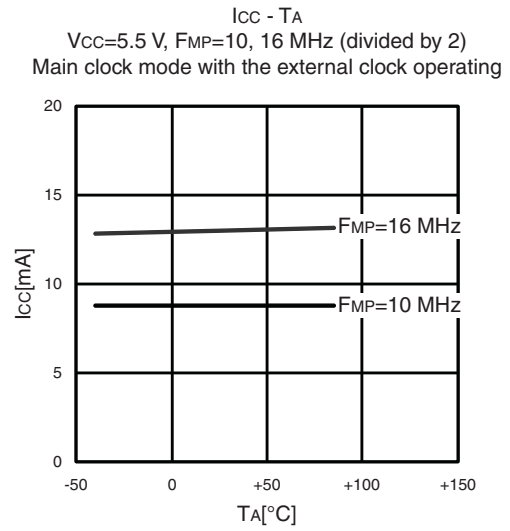
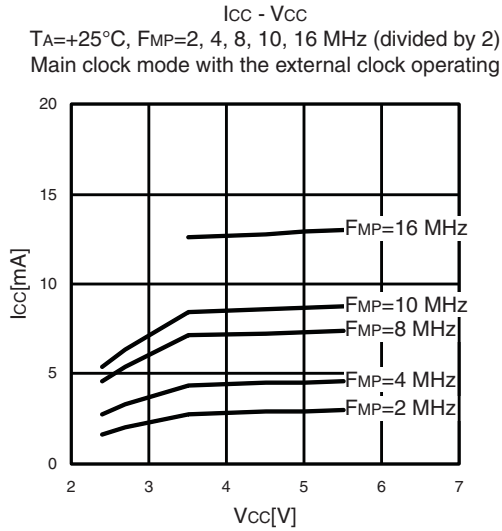

(Continued)

MB95200H/210H Series

(Continued)

I_{CCLS} - V_{CC}
 T_A=+25°C, F_{MPL}=16 kHz (divided by 2)
 Subsleep mode with the external clock operating

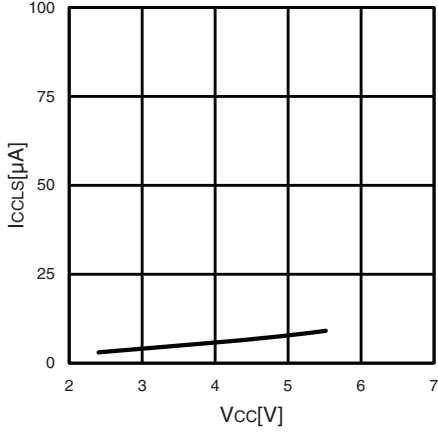

I_{CCLS} - T_A
 V_{CC}=5.5 V, F_{MPL}=16 kHz (divided by 2)
 Subsleep mode with the external clock operating

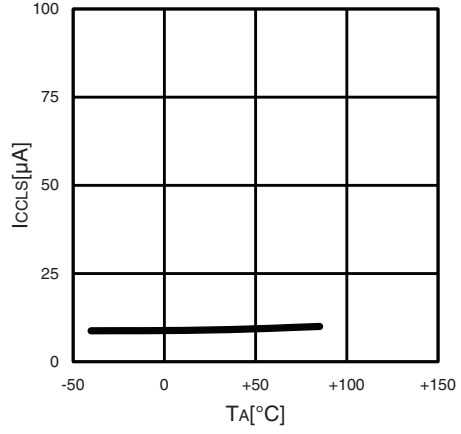

I_{CCCT} - V_{CC}
 T_A=+25°C, F_{MPL}=16 kHz (divided by 2)
 Clock mode with the external clock operating

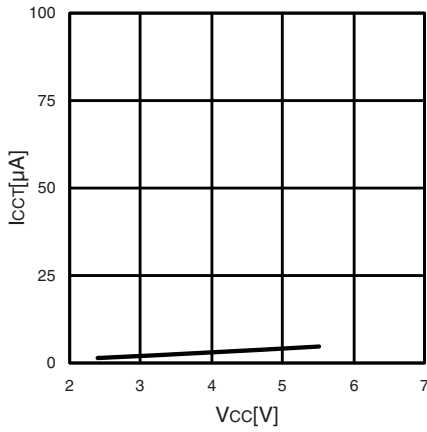

I_{CCCT} - T_A
 V=5.5 V, F_{MPL}=16 kHz (divided by 2)
 Clock mode with the external clock operating

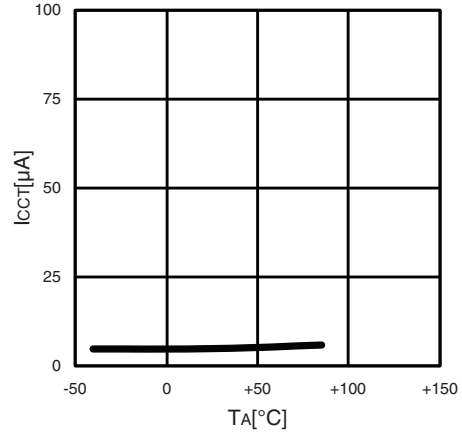

I_{CTS} - V_{CC}
 T_A=+25°C, F_{MP}=2, 4, 8, 10, 16 MHz (divided by 2)
 Timebase timer mode with the external clock operating

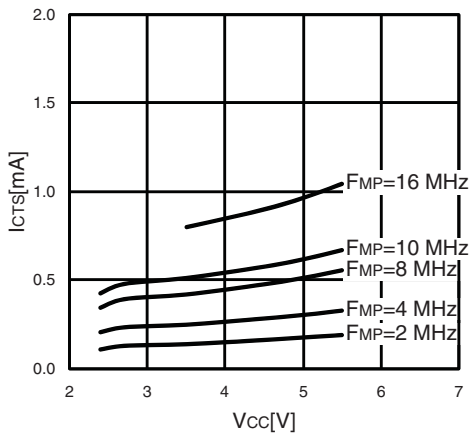

I_{CTS} - T_A
 V=5.5 V, F_{MP}=10, 16 MHz (divided by 2)
 Timebase timer mode with the external clock operating

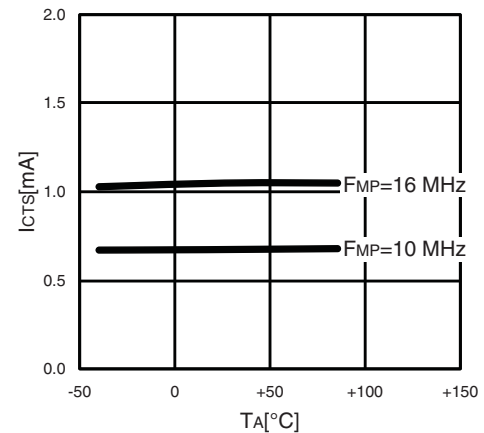

(Continued)

(Continued)

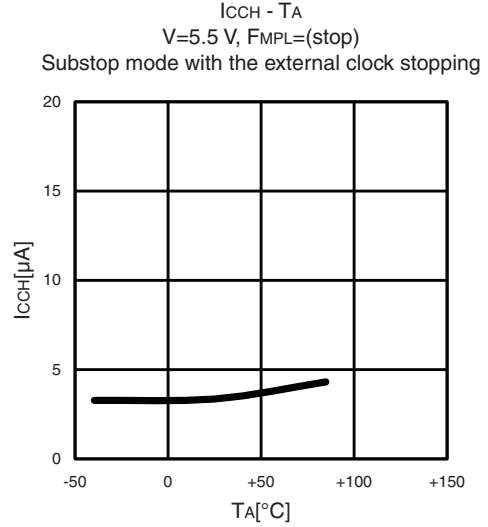
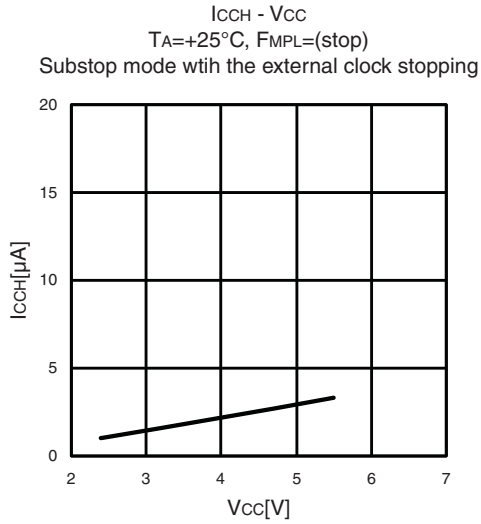

ICCMCR - Vcc
 TA=+25°C, FMP=1, 8, 10 MHz (no division)
 Main clock mode with the internal main CR clock operating

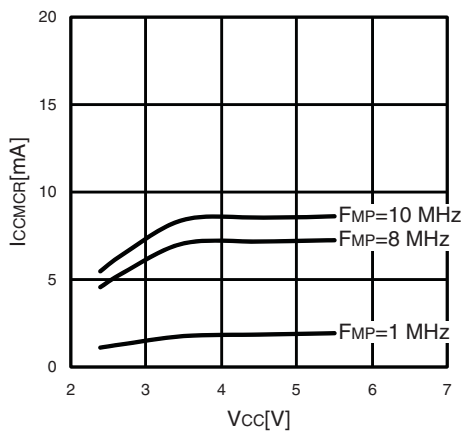

ICCMCR - TA
 V=5.5 V, FMP=1, 8, 10 MHz (no division)
 Main clock mode with the internal main CR clock operating

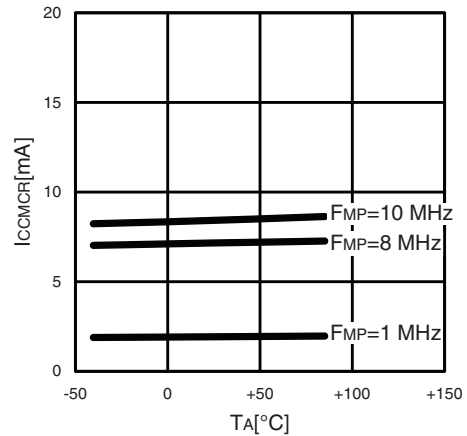

IcCSCR - Vcc
 TA=+25°C, FMPL=50 kHz (divided by 2)
 Subclock mode with the internal sub-CR clock operating

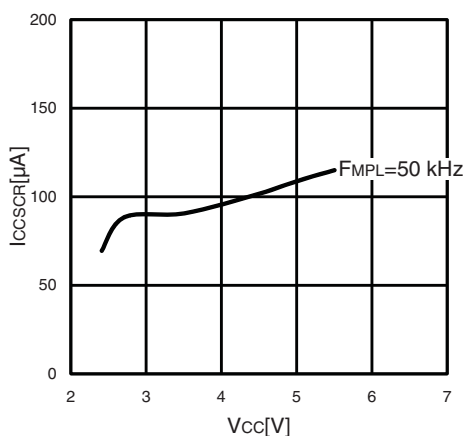

IcCSCR - TA
 Vcc=5.5 V, FMPL=50 kHz (divided by 2)
 Subclock mode with the internal sub-CR clock operating

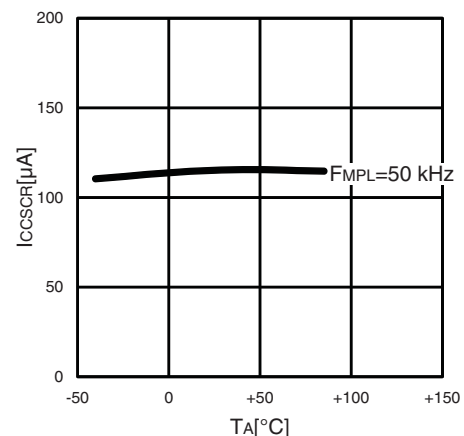

MB95200H/210H Series

• Input voltage

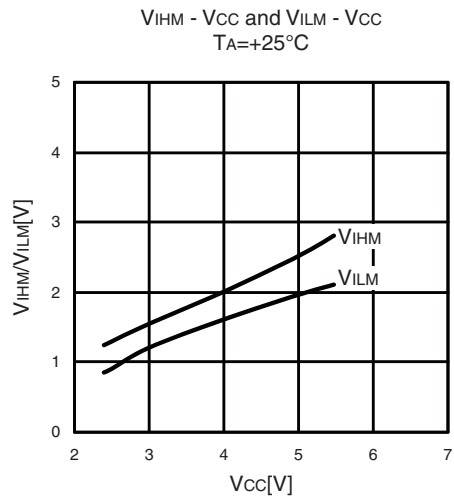
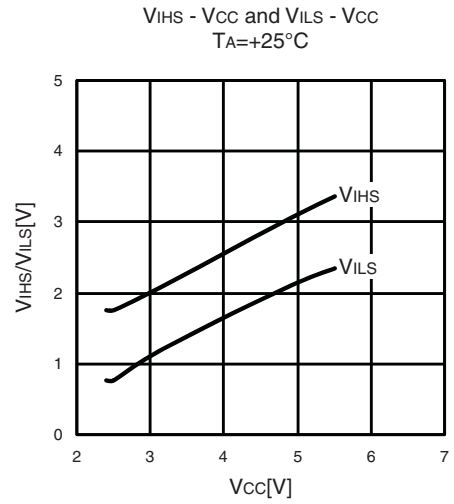
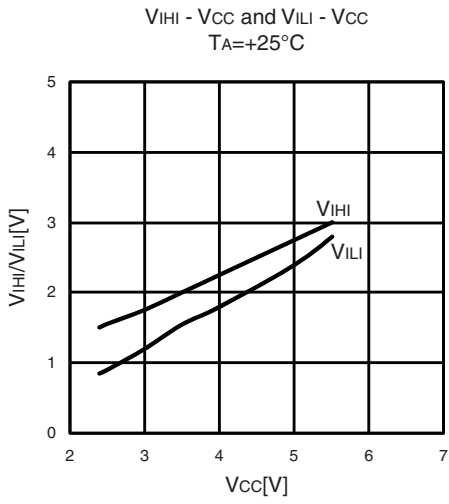

• Output voltage

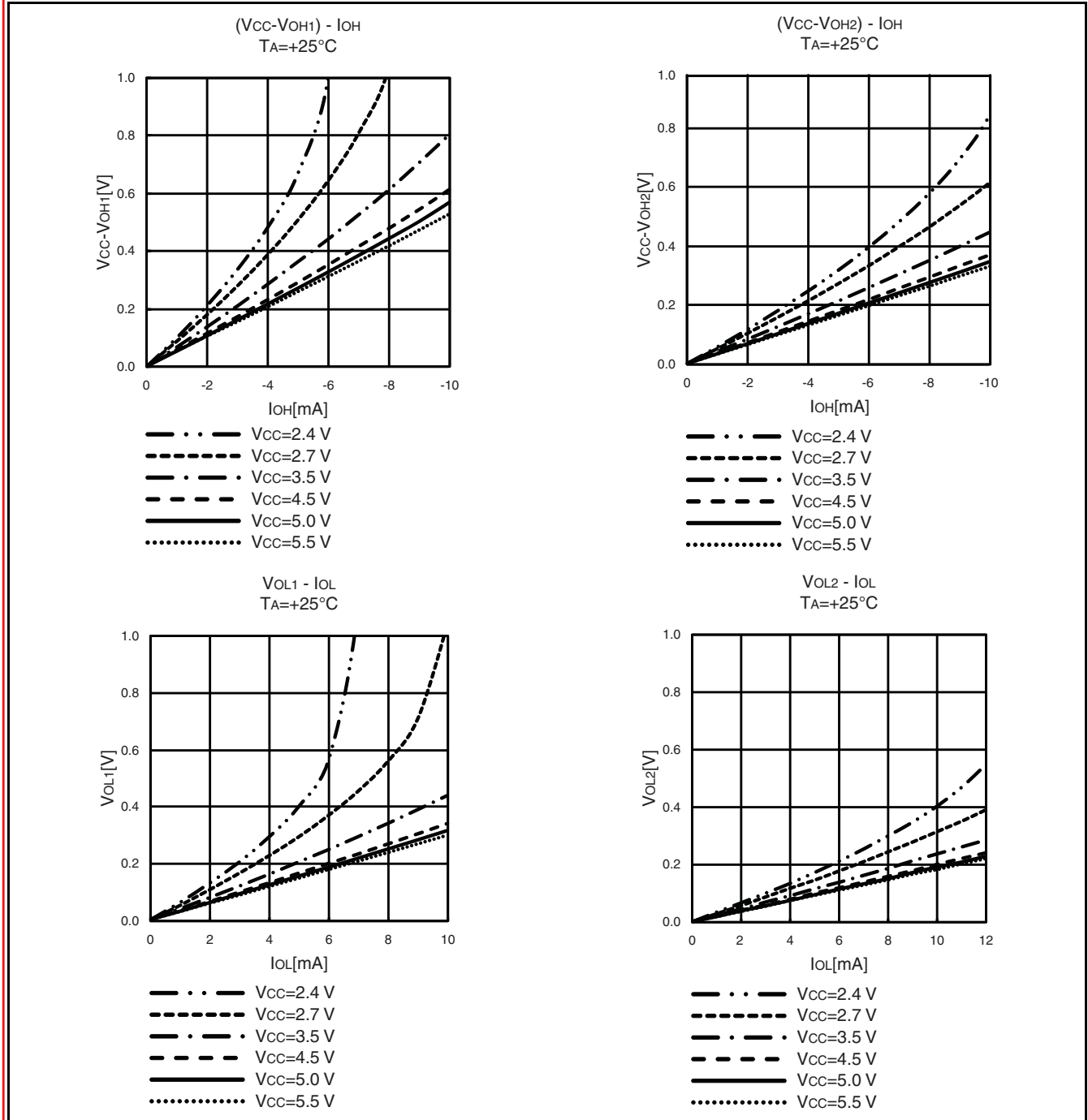

MB95200H/210H Series

- Pull-up

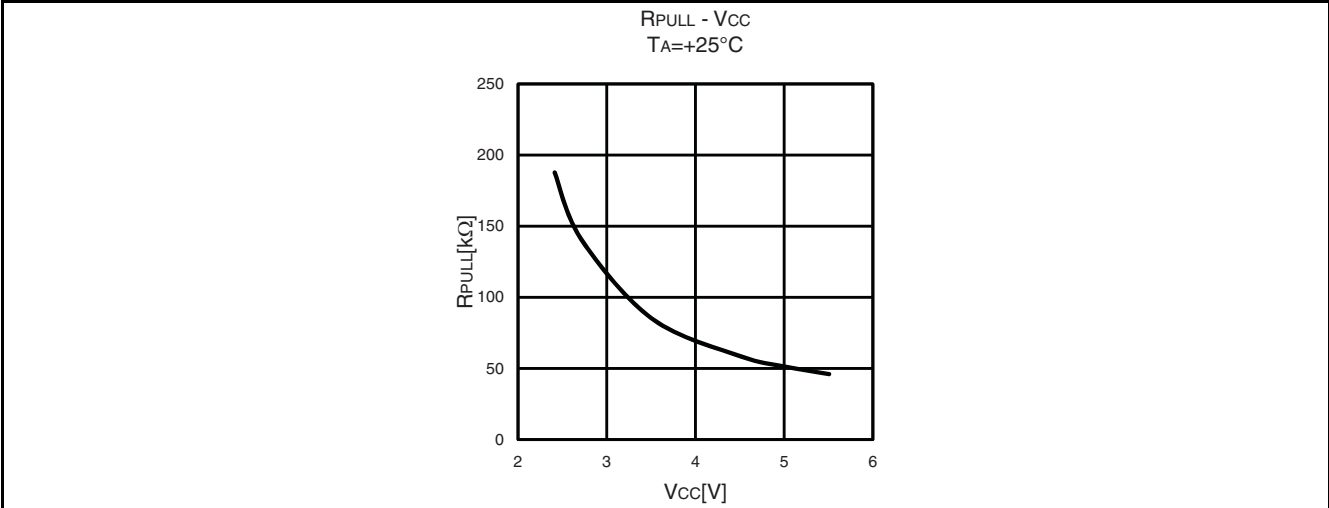

■ MASK OPTIONS

No.	Part Number	MB95F204H MB95F203H MB95F202H MB95F214H MB95F213H MB95F212H	MB95F204K MB95F203K MB95F202K MB95F214K MB95F213K MB95F212K
	Selection Method	Setting disabled	Setting disabled
1	Low-voltage detection reset <ul style="list-style-type: none"> • With low-voltage detection reset • Without low-voltage detection reset 	Without low-voltage detection reset	With low-voltage detection reset
2	Reset <ul style="list-style-type: none"> • With dedicated reset input • Without dedicated reset input 	With dedicated reset input	Without dedicated reset input

MB95200H/210H Series

■ ORDERING INFORMATION

Part Number	Package
MB95F204HP-G-SH-SNE2 MB95F204KP-G-SH-SNE2 MB95F203HP-G-SH-SNE2 MB95F203KP-G-SH-SNE2 MB95F202HP-G-SH-SNE2 MB95F202KP-G-SH-SNE2	24-pin plastic SDIP (DIP-24P-M07)
MB95F204HPF-G-SNE2 MB95F204KPF-G-SNE2 MB95F203HPF-G-SNE2 MB95F203KPF-G-SNE2 MB95F202HPF-G-SNE2 MB95F202KPF-G-SNE2	20-pin plastic SOP (FPT-20P-M09)
MB95F214HPH-G-SNE2 MB95F214KPH-G-SNE2 MB95F213HPH-G-SNE2 MB95F213KPH-G-SNE2 MB95F212HPH-G-SNE2 MB95F212KPH-G-SNE2	8-pin plastic DIP (DIP-8P-M03)
MB95F214HPF-G-SNE2 MB95F214KPF-G-SNE2 MB95F213HPF-G-SNE2 MB95F213KPF-G-SNE2 MB95F212HPF-G-SNE2 MB95F212KPF-G-SNE2	8-pin plastic SOP (FPT-8P-M08)

MB95200H/210H Series

■ PACKAGE DIMENSIONS

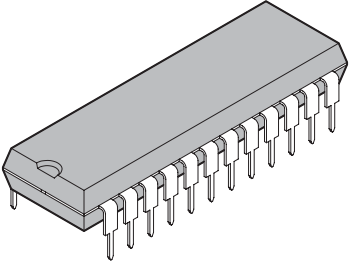
<p>24-pin plastic DIP</p>  <p>(DIP-24P-M07)</p>	Lead pitch	1.778 mm	
	Package width package length	6.40 mm 22.86 mm	
	Sealing method	Plastic mold	
	Mounting height	4.80 mm Max	

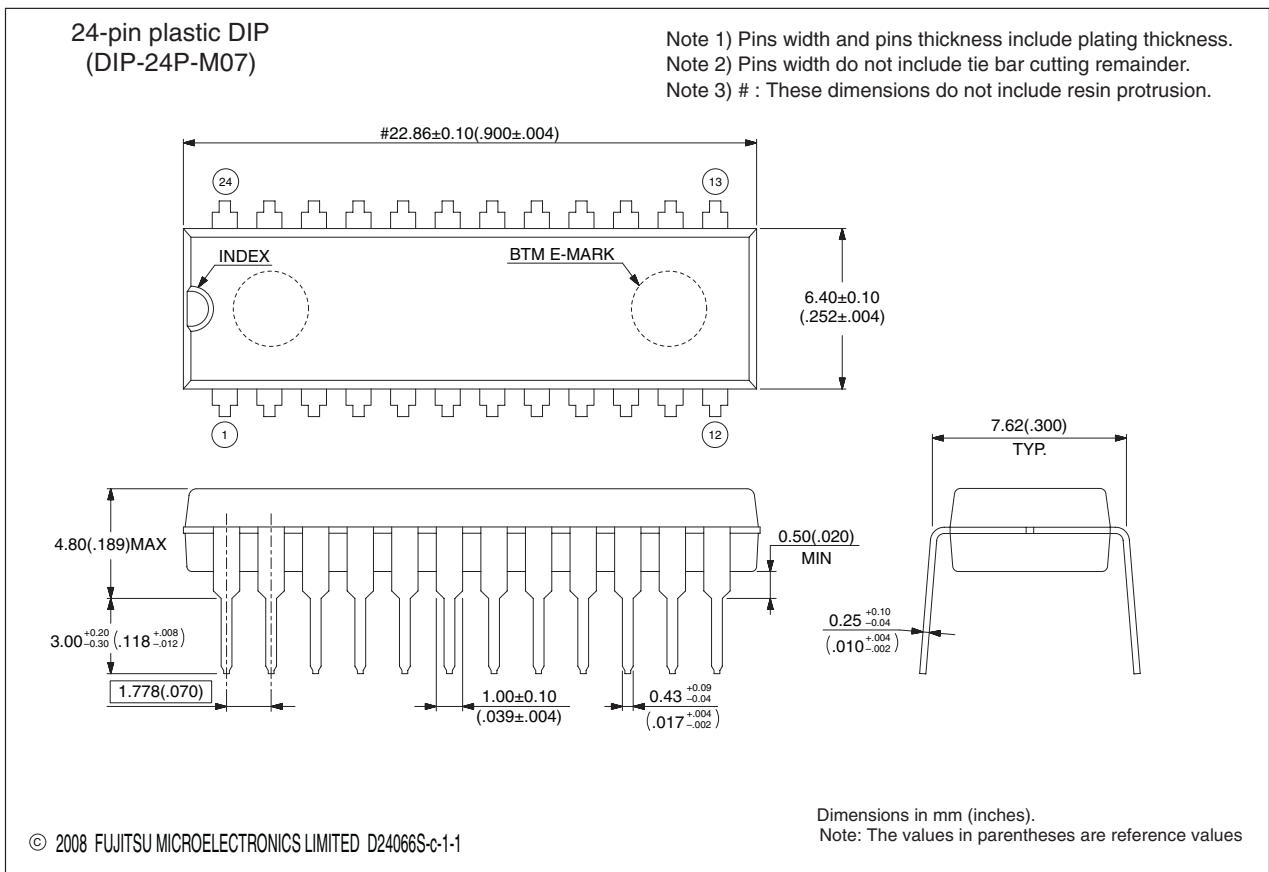

Please check the latest package dimensions at the following URL.
<http://edevice.fujitsu.com/package/en-search/>

(Continued)

MB95200H/210H Series

(Continued)

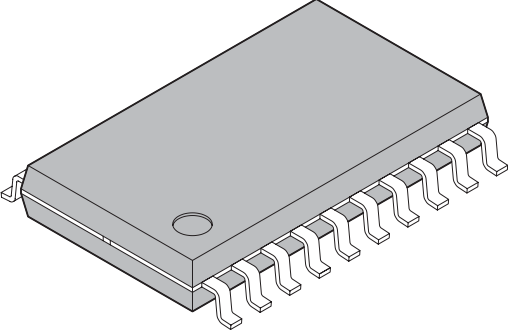
<p>20-pin plastic SOP</p>  <p>(FPT-20P-M09)</p>	Lead pitch	1.27 mm
	Package width package length	7.50 mm 12.70 mm
	Lead shape	Gullwing
	Lead bend direction	Normal bend
	Sealing method	Plastic mold
	Mounting height	2.65 mm Max

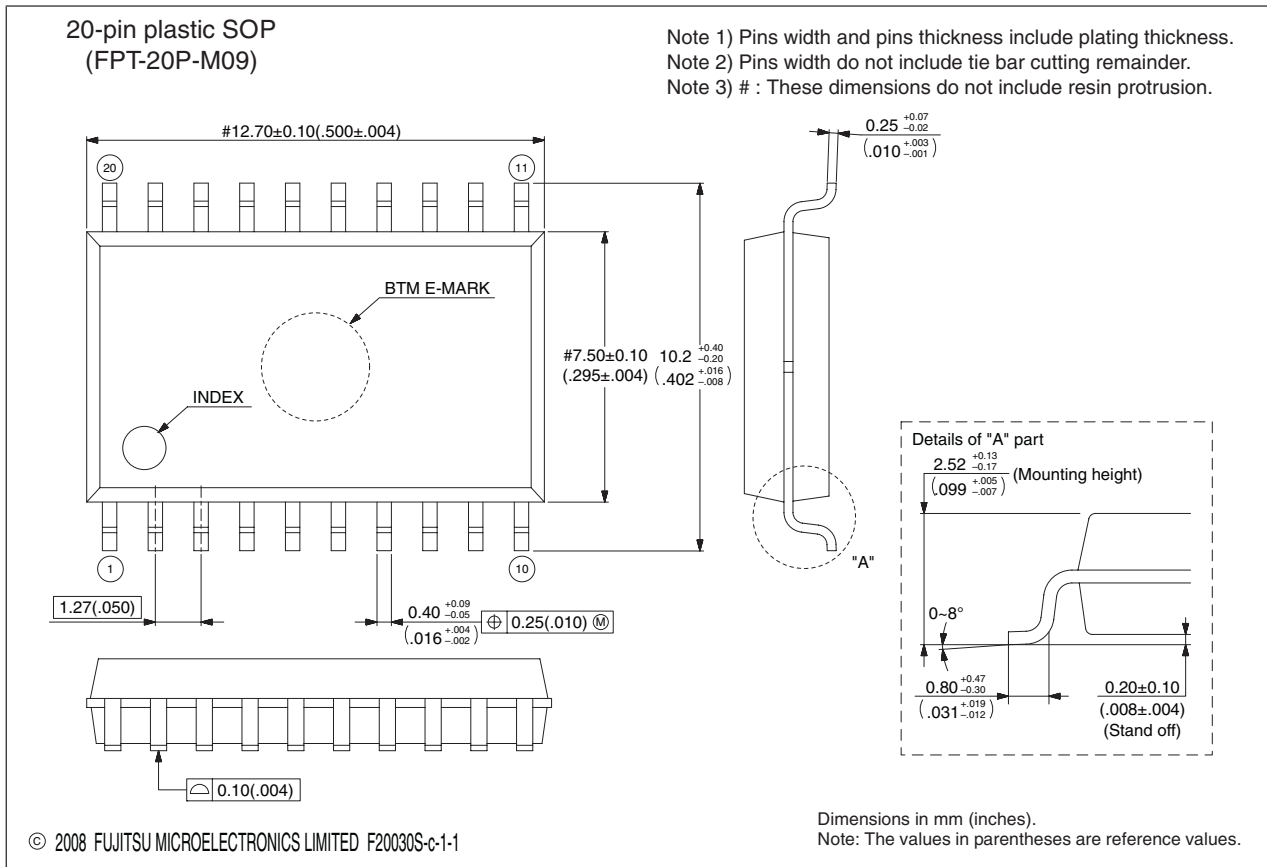

Please check the latest package dimensions at the following URL.
<http://edevice.fujitsu.com/package/en-search/>

(Continued)

MB95200H/210H Series

(Continued)

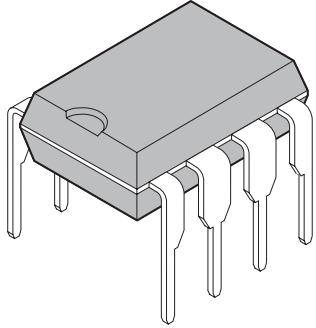
<p>8-pin plastic DIP</p>  <p>(DIP-8P-M03)</p>	Lead pitch	2.54 mm
	Sealing method	Plastic mold

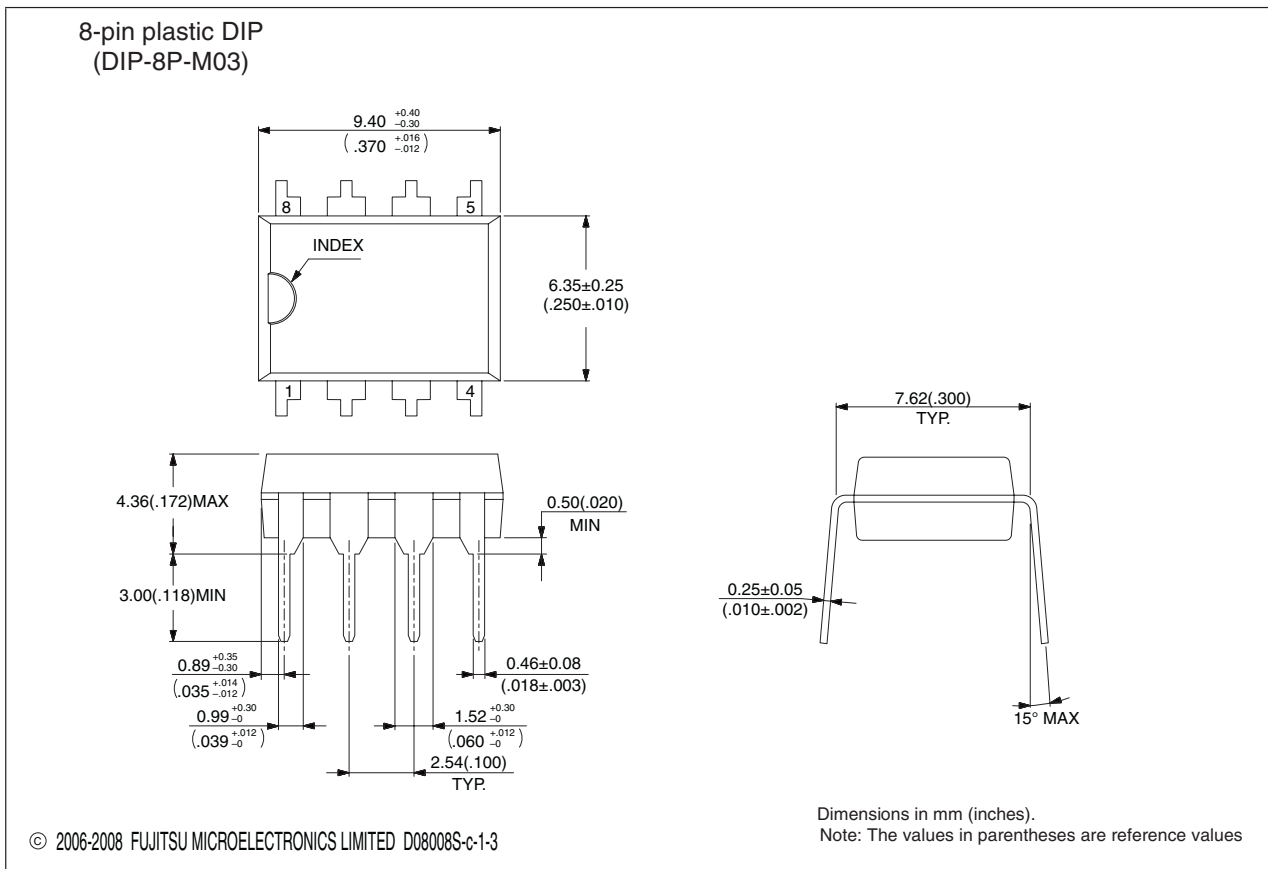

Please check the latest package dimensions at the following URL.
<http://edevice.fujitsu.com/package/en-search/>

(Continued)

MB95200H/210H Series

(Continued)

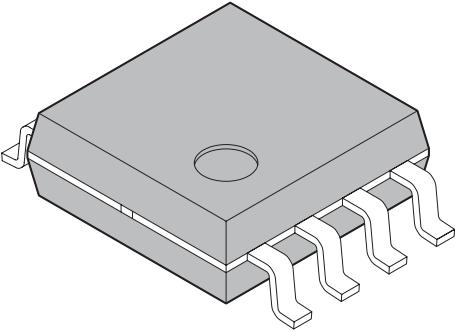
<p>8-pin plastic SOP</p>  <p>(FPT-8P-M08)</p>	Lead pitch	1.27 mm
	Package width package length	5.30 mm 5.24 mm
	Lead shape	Gullwing
	Lead bend direction	Normal bend
	Sealing method	Plastic mold
	Mounting height	2.10 mm Max

8-pin plastic SOP
(FPT-8P-M08)

Note 1) Pins width and pins thickness include plating thickness.
Note 2) Pins width do not include tie bar cutting remainder.
Note 3) # : These dimensions do not include resin protrusion.

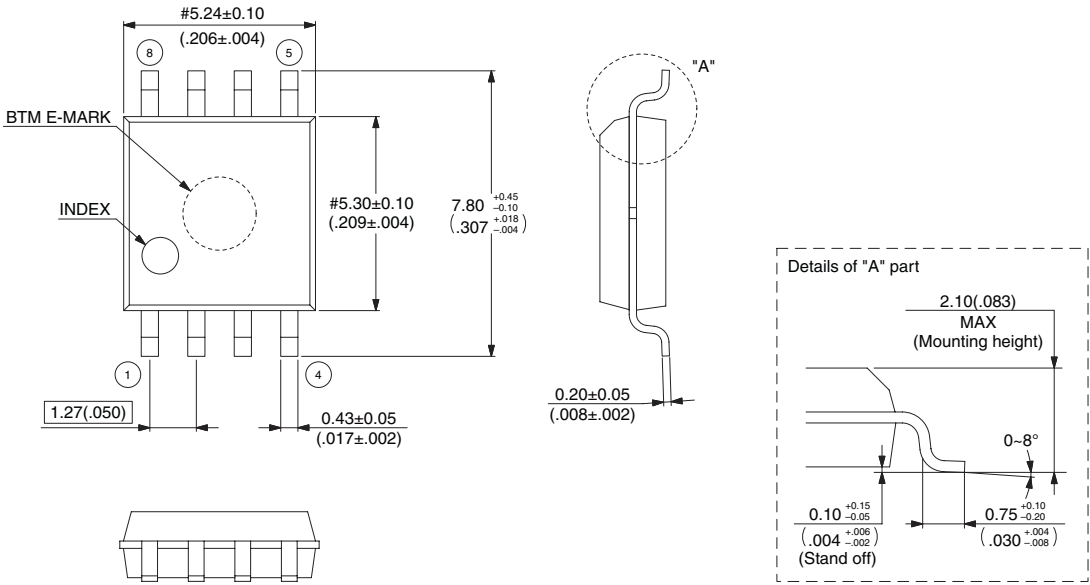

Top view dimensions:
 Pin pitch: 1.27(.050)
 Pin width: 0.43±0.05 (.017±.002)
 Pin thickness: 0.20±0.05 (.008±.002)
 Package width: #5.24±0.10 (.206±.004)
 Package length: #5.30±0.10 (.209±.004)
 Total length: 7.80^{+0.45}/_{-0.10} (.307^{+0.018}/_{-.004})

Side view dimensions:
 Mounting height: 2.10(.083) MAX
 Stand off: 0.10^{+0.15}/_{-0.05} (.004^{+0.006}/_{-.002})
 Lead length: 0.75^{+0.10}/_{-0.20} (.030^{+0.004}/_{-.008})
 Lead angle: 0-8°

© 2008 FUJITSU MICROELECTRONICS LIMITED F08016S-c-1-1

Dimensions in mm (inches).
Note: The values in parentheses are reference values.

Please check the latest package dimensions at the following URL.
<http://edevice.fujitsu.com/package/en-search/>

■ MAJOR REVISIONS IN THIS EDITION

Page	Section	Revision Details
—	—	Preliminary Data Sheet → Data Sheet
—	■PROGRAMMING FLASH MEMORY MICROCONTROLLERS USING SERIAL PROGRAMMER	This section was deleted.
57 to 62	■SAMPLE ELECTRICAL CHARACTERISTICS	This is a new section.

MEMO

MEMO

MB95200H/210H Series

FUJITSU MICROELECTRONICS LIMITED

Shinjuku Dai-Ichi Seimei Bldg., 7-1, Nishishinjuku 2-chome,
Shinjuku-ku, Tokyo 163-0722, Japan
Tel: +81-3-5322-3347 Fax: +81-3-5322-3387
<http://jp.fujitsu.com/fml/en/>

For further information please contact:

North and South America

FUJITSU MICROELECTRONICS AMERICA, INC.
1250 E. Arques Avenue, M/S 333
Sunnyvale, CA 94085-5401, U.S.A.
Tel: +1-408-737-5600 Fax: +1-408-737-5999
<http://www.fma.fujitsu.com/>

Asia Pacific

FUJITSU MICROELECTRONICS ASIA PTE. LTD.
151 Lorong Chuan,
#05-08 New Tech Park 556741 Singapore
Tel : +65-6281-0770 Fax : +65-6281-0220
<http://www.fmal.fujitsu.com/>

Europe

FUJITSU MICROELECTRONICS EUROPE GmbH
Pittlerstrasse 47, 63225 Langen, Germany
Tel: +49-6103-690-0 Fax: +49-6103-690-122
<http://emea.fujitsu.com/microelectronics/>

FUJITSU MICROELECTRONICS SHANGHAI CO., LTD.

Rm. 3102, Bund Center, No.222 Yan An Road (E),
Shanghai 200002, China
Tel : +86-21-6146-3688 Fax : +86-21-6335-1605
<http://cn.fujitsu.com/fmc/>

Korea

FUJITSU MICROELECTRONICS KOREA LTD.
206 Kosmo Tower Building, 1002 Daechi-Dong,
Gangnam-Gu, Seoul 135-280, Republic of Korea
Tel: +82-2-3484-7100 Fax: +82-2-3484-7111
<http://kr.fujitsu.com/fmk/>

FUJITSU MICROELECTRONICS PACIFIC ASIA LTD.

10/F., World Commerce Centre, 11 Canton Road,
Tsimshatsui, Kowloon, Hong Kong
Tel : +852-2377-0226 Fax : +852-2376-3269
<http://cn.fujitsu.com/fmc/en/>

Specifications are subject to change without notice. For further information please contact each office.

All Rights Reserved.

The contents of this document are subject to change without notice.

Customers are advised to consult with sales representatives before ordering.

The information, such as descriptions of function and application circuit examples, in this document are presented solely for the purpose of reference to show examples of operations and uses of FUJITSU MICROELECTRONICS device; FUJITSU MICROELECTRONICS does not warrant proper operation of the device with respect to use based on such information. When you develop equipment incorporating the device based on such information, you must assume any responsibility arising out of such use of the information.

FUJITSU MICROELECTRONICS assumes no liability for any damages whatsoever arising out of the use of the information.

Any information in this document, including descriptions of function and schematic diagrams, shall not be construed as license of the use or exercise of any intellectual property right, such as patent right or copyright, or any other right of FUJITSU MICROELECTRONICS or any third party or does FUJITSU MICROELECTRONICS warrant non-infringement of any third-party's intellectual property right or other right by using such information. FUJITSU MICROELECTRONICS assumes no liability for any infringement of the intellectual property rights or other rights of third parties which would result from the use of information contained herein.

The products described in this document are designed, developed and manufactured as contemplated for general use, including without limitation, ordinary industrial use, general office use, personal use, and household use, but are not designed, developed and manufactured as contemplated (1) for use accompanying fatal risks or dangers that, unless extremely high safety is secured, could have a serious effect to the public, and could lead directly to death, personal injury, severe physical damage or other loss (i.e., nuclear reaction control in nuclear facility, aircraft flight control, air traffic control, mass transport control, medical life support system, missile launch control in weapon system), or (2) for use requiring extremely high reliability (i.e., submersible repeater and artificial satellite).

Please note that FUJITSU MICROELECTRONICS will not be liable against you and/or any third party for any claims or damages arising in connection with above-mentioned uses of the products.

Any semiconductor devices have an inherent chance of failure. You must protect against injury, damage or loss from such failures by incorporating safety design measures into your facility and equipment such as redundancy, fire protection, and prevention of over-current levels and other abnormal operating conditions.

Exportation/release of any products described in this document may require necessary procedures in accordance with the regulations of the Foreign Exchange and Foreign Trade Control Law of Japan and/or US export control laws.

The company names and brand names herein are the trademarks or registered trademarks of their respective owners.