

CMOS Generic 24-Pin Reprogrammable Logic Device

Features

- **Fast**
 - Commercial: $t_{PD} = 15$ ns, $t_{CO} = 10$ ns, $t_S = 12$ ns
 - Military: $t_{PD} = 20$ ns, $t_{CO} = 15$ ns, $t_S = 15$ ns
- **Low power**
 - I_{CC} max.: 70 mA, commercial
 - I_{CC} max.: 100 mA, military
- **Commercial and military temperature range**
- **User-programmable output cells**
 - Selectable for registered or combinatorial operation
 - Output polarity control
 - Output enable source selectable from pin 13 or product term

- **Generic architecture to replace standard logic functions including: 20L10, 20L8, 20R8, 20R6, 20R4, 12L10, 14L8, 16L6, 18L4, 20L2, and 20V8**
- **Eight product terms and one OE product term per output**
- **CMOS EPROM technology for reprogrammability**
- **Highly reliable**
 - Uses proven EPROM technology
 - Fully AC and DC tested
 - Security feature prevents logic pattern duplication
 - $\pm 10\%$ power supply voltage and higher noise immunity

Functional Description

Cypress PLD devices are high-speed electrically programmable logic devices. These devices utilize the sum-of-products (AND-OR) structure providing users the ability to program custom logic functions for unique requirements.

In an unprogrammed state the AND gates are connected via EPROM cells to both the true and complement of every input. By selectively programming the EPROM cells, AND gates may be connected to either the true or complement or disconnected from both true and complement inputs.

Cypress PLDC20G10 uses an advanced 0.8-micron CMOS technology and a proven EPROM cell as the programmable element. This technology and the inherent

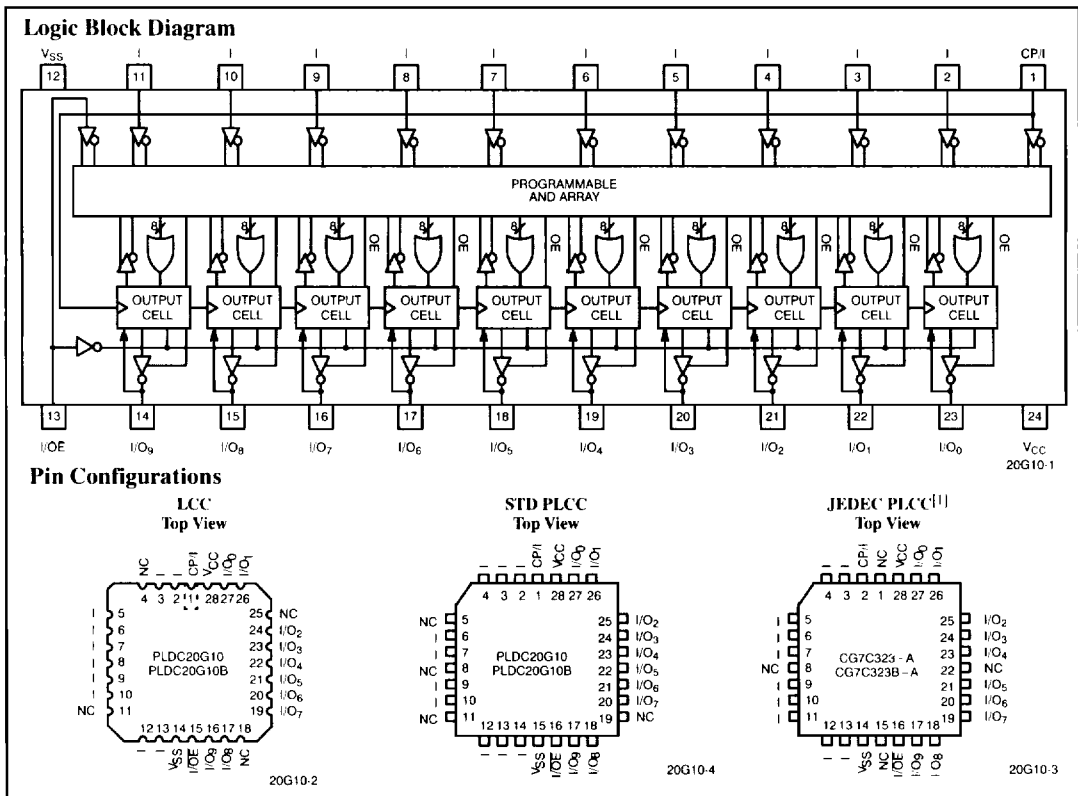

Note:

1. The CG7C323 is the PLDC20G10 packaged in the JEDEC-compatible 28-pin PLCC pinout. Pin function and pin order is identical for

both PLCC pinouts. The difference is in the location of the "no connect" or NC pins.

Selection Guide

Generic Part Number	I _{CC} (mA)		t _{PD} (ns)		t _S (ns)		t _{CO} (ns)	
	Com/Ind	Mil	Com/Ind	Mil	Com/Ind	Mil	Com/Ind	Mil
20G10B-15	70		15		12		10	
20G10B-20	70	100	20	20	12	15	12	15
20G10B-25		100		25		18		15
20G10-25	55		25		15		15	
20G10-30		80		30		20		20
20G10-35	55		35		30		25	
20G10-40		80		40		35		25

Functional Description (continued)

advantage of being able to program and erase each cell enhances the reliability and testability of the circuit. This reduces the burden on the customer to test and to handle rejects.

A preload function allows the registered outputs to be preset to any pattern during testing. Preload is important for testing the functionality of the Cypress PLD device.

20G10 Functional Description

The PLDC20G10 is a generic 24-pin device that can be programmed to logic functions that include but are not limited to: 20L10, 20L8, 20R8, 20R6, 20R4, 12L10, 14L8, 16L6, 18L4, 20L2, and 20V8. Thus, the PLDC20G10 provides significant design, inventory and programming flexibility over dedicated 24-pin devices. It is executed in a 24-pin 300-mil molded DIP and a 300-mil windowed cerDIP. It provides up to 22 inputs and 10 outputs. When the windowed cerDIP is exposed to UV light, the 20G10 is erased and then can be reprogrammed.

The programmable output cell provides the capability of defining the architecture of each output individually. Each of the 10 output cells may be configured with registered or combinatorial outputs, active HIGH or active LOW outputs, and product term or Pin 13 generated output enables. Three architecture bits determine the configurations as shown in the Configuration Table and in Figures 1 through 8. A total of eight different configurations are possible,

with the two most common shown in Figure 3 and Figure 5. The default or unprogrammed state is registered/active/LOW/Pin 11 OE. The entire programmable output cell is shown in the next section.

The architecture bit 'C1' controls the registered/combinatorial option. In either combinatorial or registered configuration, the output can serve as an I/O pin, or if the output is disabled, as an input only. Any unused inputs should be tied to ground. In either registered or combinatorial configuration, the output of the register is fed back to the array. This allows the creation of control-state machines by providing the next state. The register is clocked by the signal from Pin 1. The register is initialized on power up to Q output LOW and \bar{Q} output HIGH.

In both the combinatorial and registered configurations, the source of the output enable signal can be individually chosen with architecture bit 'C2'. The OE signal may be generated within the array, or from the external OE (Pin 13). The Pin 13 allows direct control of the outputs, hence having faster enable/disable times.

Each output cell can be configured for output polarity. The output can be either active HIGH or active LOW. This option is controlled by architecture bit 'C0'.

Along with this increase in functional density, the Cypress PLDC20G10 provides lower-power operation through the use of CMOS technology and increased testability with a register preload feature.

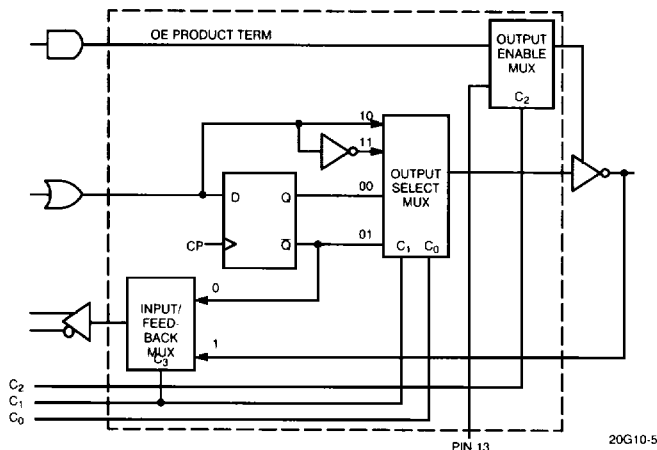
Programmable Output Cell

Configuration Table

Figure	C ₂	C ₁	C ₀	Configuration
1	0	0	0	Product Term OE/Registered/Active LOW
2	0	0	1	Product Term OE/Registered/Active HIGH
5	0	1	0	Product Term OE/Combinatorial/Active LOW
6	0	1	1	Product Term OE/Combinatorial/Active HIGH
3	1	0	0	Pin 13 OE/Registered/Active LOW
4	1	0	1	Pin 13 OE/Registered/Active HIGH
7	1	1	0	Pin 13 OE/Combinatorial/Active LOW
8	1	1	1	Pin 13 OE/Combinatorial/Active HIGH

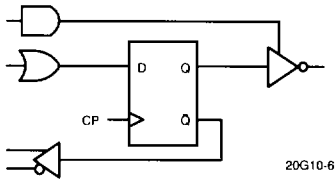
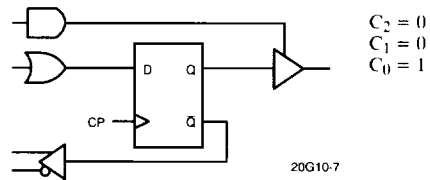
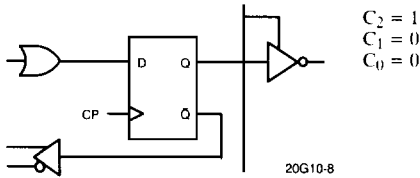
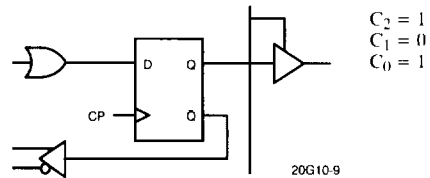
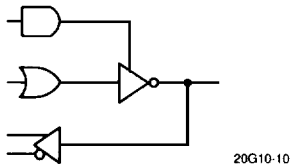
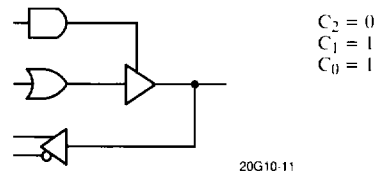
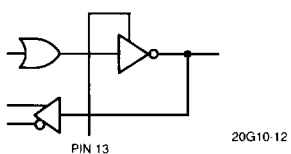
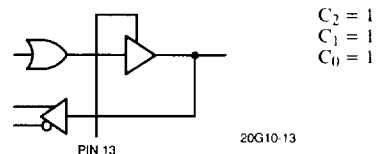
Registered Output Configurations

Figure 1. Product Term OE/Active LOW

Figure 2. Product Term OE/Active HIGH

Figure 3. Pin 13 OE/Active LOW

Figure 4. Pin 13 OE/Active HIGH
Combinatorial Output Configurations^[2]

Figure 5. Product Term OE/Active LOW

Figure 6. Product Term OE/Active HIGH

Figure 7. Pin 13 OE/Active LOW

Figure 8. Pin 13 OE/Active HIGH
Note:

- Bidirectional I/O configurations are possible only when the combinatorial output option is selected



Maximum Ratings

(Above which the useful life may be impaired. For user guidelines, not tested.)

Storage Temperature -65°C to +150°C
 Ambient Temperature with Power Applied -55°C to +125°C
 Supply Voltage to Ground Potential -0.5V to +7.0V
 DC Voltage Applied to Outputs in High Z State -0.5V to +7.0V
 DC Input Voltage -3.0V to +7.0V
 Output Current into Outputs (LOW) 16 mA
 DC Programming Voltage
 PLDC20G10B and CG7C323B-A 13.0V
 PLDC20G10 and CG7C323-A 14.0V

Latch-Up Current >200 mA
 Static Discharge Voltage (per MIL-STD-883, Method 8015) >500V

Operating Range

Range	Ambient Temperature	V _{CC}
Commercial	0°C to +75°C	5V ±10%
Military ^[3]	-55°C to +125°C	5V ±10%
Industrial	-40°C to +85°C	5V ±10%

Electrical Characteristics Over the Operating Range (Unless Otherwise Noted)^[4]

Parameter	Description	Test Conditions			Min.	Max.	Unit
		V _{CC} = Min., V _{IN} = V _{IH} or V _{IL}	I _{OH} = -3.2 mA	Com'/Ind			
V _{OH}	Output HIGH Voltage		I _{OH} = -2 mA	Military	2.4		V
V _{OL}	Output LOW Voltage	V _{CC} = Min., V _{IN} = V _{IH} or V _{IL}	I _{OL} = 24 mA	Com'/Ind			
V _{IH}	Input HIGH Level	Guaranteed Input Logical HIGH Voltage for All Inputs ^[5]			2.0		V
V _{IL}	Input LOW Level	Guaranteed Input Logical LOW Voltage for All Inputs ^[5]					
I _{Ix}	Input Leakage Current	V _{SS} ≤ V _{IN} ≤ V _{CC}			-10	+10	µA
I _{SC}	Output Short Circuit Current	V _{CC} = Max., V _{OUT} = 0.5V ^[6, 7]					
I _{CC}	Power Supply Current	0 ≤ V _{IN} ≤ V _{CC} , V _{CC} = Max., I _{OUT} = 0 mA, Unprogrammed Device	Com'/Ind -15, -20			70	mA
			Com'/Ind -25, -35				
			Military -20, -25				
			Military -30, -40				
I _{OZ}	Output Leakage Current	V _{CC} = Max., V _{SS} ≤ V _{OUT} ≤ V _{CC}			-100	100	µA

Capacitance^[7]

Parameter	Description	Test Conditions	Max.	Unit
C _{IN}	Input Capacitance	T _A = 25°C, f = 1 MHz	10	pF
C _{OUT}	Output Capacitance	V _{IN} = 2.0V, V _{CC} = 5.0V	10	pF

Notes:

- T_A is the "instant on" case temperature.
- See the last page of this specification for Group A subgroup testing information.
- These are absolute values with respect to device ground. All overshoots due to system or tester noise are included.
- Not more than one output should be tested at a time. Duration of the short circuit should not be more than one second. V_{OUT} = 0.5V has been chosen to avoid test problems caused by tester ground degradation.
- Tested initially and after any design or process changes that may affect these parameters.

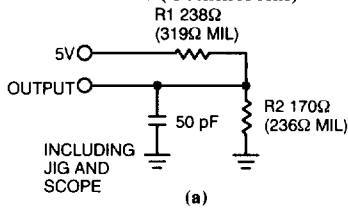
AC Test Loads and Waveforms (Commercial)

(a)

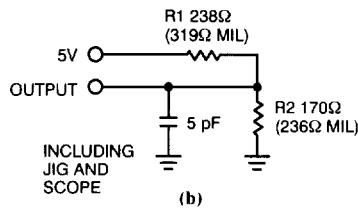
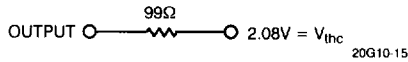
Equivalent to: THÉVENIN EQUIVALENT (Commercial)

(b)

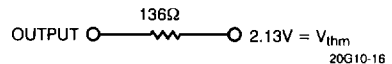
Equivalent to: THÉVENIN EQUIVALENT (Military/Industrial)



20G10-14

Switching Characteristics Over Operating Range^[3, 8, 9]

Parameter	Description	Commercial								Unit
		B-15		B-20		-25		-35		
		Min.	Max.	Min.	Max.	Min.	Max.	Min.	Max.	
t_{PD}	Input or Feedback to Non-Registered Output		15		20		25		35	ns
t_{EA}	Input to Output Enable		15		20		25		35	ns
t_{ER}	Input to Output Disable		15		20		25		35	ns
t_{PZX}	Pin 11 to Output Enable		12		15		20		25	ns
t_{PXZ}	Pin 11 to Output Disable		12		15		20		25	ns
t_{CO}	Clock to Output		10		12		15		25	ns
t_S	Input or Feedback Set-Up Time	12		12		15		30		ns
t_H	Hold Time	0		0		0		0		ns
$t_p^{[10]}$	Clock Period	22		24		30		55		ns
t_{WH}	Clock High Time	8		10		12		17		ns
t_{WL}	Clock Low Time	8		10		12		17		ns
$f_{MAX}^{[11]}$	Maximum Frequency	45.4		41.6		33.3		18.1		MHz

Notes:

8. Part (a) of AC Test Loads and Waveforms used for all parameters except t_{ER} , t_{PZX} , and t_{PXZ} . Part (b) of AC Test Loads and Waveforms used for t_{ER} , t_{PZX} , and t_{PXZ} .
9. The parameters t_{ER} and t_{PXZ} are measured as the delay from the input disable logic threshold transition to $V_{OH} - 0.5V$ for an enabled HIGH output or $V_{OL} + 0.5V$ for an enabled LOW input.
10. t_p minimum guaranteed clock period is that guaranteed for state machine operation and is calculated from $t_p = t_S + t_{CO}$. The minimum guaranteed period for registered data path operation (no feedback) can be calculated as the greater of $(t_{WH} + t_{WL})$ or $(t_S + t_H)$.
11. f_{MAX} , minimum guaranteed operating frequency, is that guaranteed for state machine operation and is calculated from $f_{MAX} = 1/(t_S + t_{CO})$. The minimum guaranteed f_{MAX} for registered data path operation (no feedback) can be calculated as the lower of $1/(t_{WH} + t_{WL})$ or $1/(t_S + t_H)$.

Switching Characteristics Over Operating Range^[3, 8, 9] (continued)

Parameter	Description	Military/Industrial								Unit
		B-20		B-25		-30		-40		
		Min.	Max.	Min.	Max.	Min.	Max.	Min.	Max.	
t_{PD}	Input or Feedback to Non-Registered Output		20		25		30		40	ns
t_{EA}	Input to Output Enable		20		25		30		40	ns
t_{ER}	Input to Output Disable		20		25		30		40	ns
t_{PZX}	Pin 11 to Output Enable		17		20		25		25	ns
t_{PXZ}	Pin 11 to Output Disable		17		20		25		25	ns
t_{CO}	Clock to Output		15		15		20		25	ns
t_S	Input or Feedback Set-Up Time	15		18		20		35		ns
t_H	Hold Time	0		0		0		0		ns
$t_p^{[10]}$	Clock Period	30		33		40		60		ns
t_{WH}	Clock High Time	12		14		16		22		ns
t_{WL}	Clock Low Time	12		14		16		22		ns
$f_{MAX}^{[11]}$	Maximum Frequency	33.3		30.3		25.0		16.6		MHz

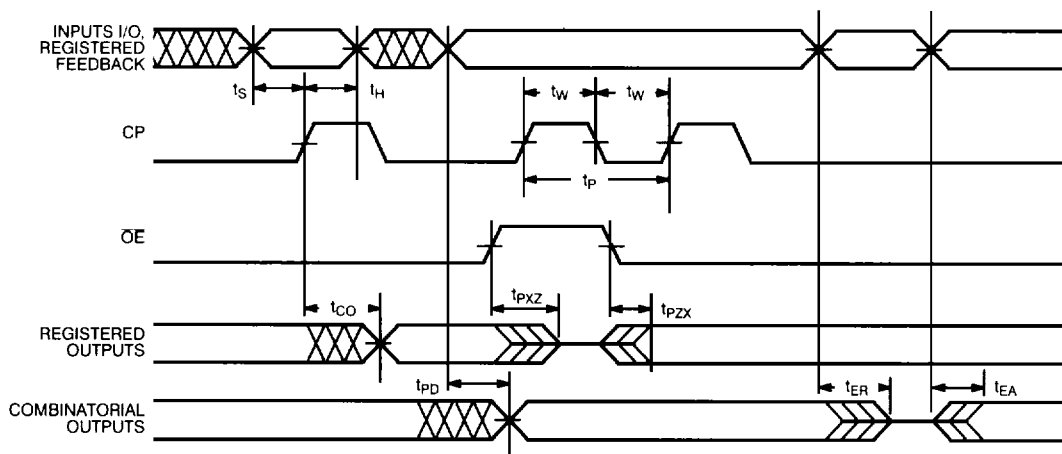
Switching Waveform

20G10-17

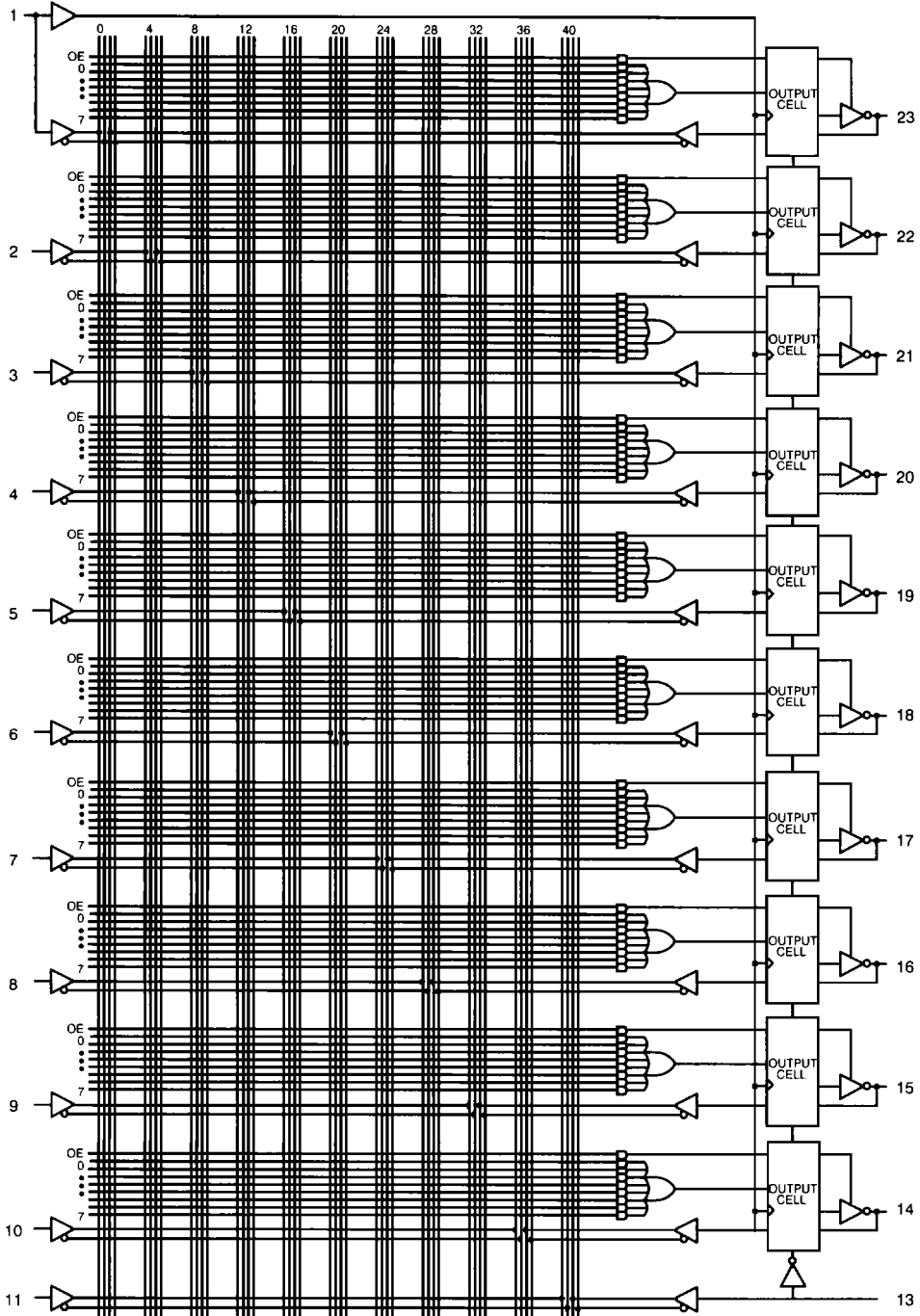
Functional Logic Diagram

2

Ordering Information

t_{PD} (ns)	t_S (ns)	t_{CO} (ns)	I_{CC} (mA)	Ordering Code	Package Name	Package Type	Operating Range
15	12	10	70	PLDC20G10B-15JC/JI	J64	28-Lead Plastic Leaded Chip Carrier	Commercial/ Industrial
				PLDC20G10B-15PC/PI	P13	24-Lead (300-Mil) Molded DIP	
				PLDC20G10B-15WC	W14	24-Lead (300-Mil) Windowed CerDIP	
				CG7C323B-A15JC/JI ¹¹	J64	28-Lead Plastic Leaded Chip Carrier	
20	12	12	70	PLDC20G10B-20JC/JI	J64	28-Lead Plastic Leaded Chip Carrier	Commercial/ Industrial
				PLDC20G10B-20PC/PI	P13	24-Lead (300-Mil) Molded DIP	
				PLDC20G10B-20WC	W14	24-Lead (300-Mil) Windowed CerDIP	
				CG7C323B-A20JC/JI ¹¹	J64	28-Lead Plastic Leaded Chip Carrier	
20	15	15	100	PLDC20G10B-20DMB	D14	24-Lead (300-Mil) CerDIP	Military
				PLDC20G10B-20LMB	L64	28-Square Leadless Chip Carrier	
				PLDC20G10B-20WMB	W14	24-Lead (300-Mil) Windowed CerDIP	
25	15	15	55	PLDC20G10-25JC/JI	J64	28-Lead Plastic Leaded Chip Carrier	Commercial/ Industrial
				PLDC20G10-25PC/PI	P13	24-Lead (300-Mil) Molded DIP	
				PLDC20G10-25WC	W14	24-Lead (300-Mil) Windowed CerDIP	
				CG7C323-A25JC/JI ¹¹	J64	28-Lead Plastic Leaded Chip Carrier	
25	18	15	100	PLDC20G10B-25DMB	D14	24-Lead (300-Mil) CerDIP	Military
				PLDC20G10B-25LMB	L64	28-Square Leadless Chip Carrier	
				PLDC20G10B-25WMB	W14	24-Lead (300-Mil) Windowed CerDIP	
30	20	20	80	PLDC20G10-30DMB	D14	24-Lead (300-Mil) CerDIP	Military
				PLDC20G10-30LMB	L64	28-Square Leadless Chip Carrier	
				PLDC20G10-30WMB	W14	24-Lead (300-Mil) Windowed CerDIP	
35	30	25	55	PLDC20G10-35JC/JI	J64	28-Lead Plastic Leaded Chip Carrier	Commercial/ Industrial
				PLDC20G10-35PC/PI	P13	24-Lead (300-Mil) Molded DIP	
				PLDC20G10-35WC	W14	24-Lead (300-Mil) Windowed CerDIP	
				CG7C323-A35JC/JI ¹¹	J64	28-Lead Plastic Leaded Chip Carrier	
40	35	25	80	PLDC20G10-40DMB	D14	24-Lead (300-Mil) CerDIP	Military
				PLDC20G10-40LMB	L64	28-Square Leadless Chip Carrier	
				PLDC20G10-40WMB	W14	24-Lead (300-Mil) Windowed CerDIP	

MILITARY SPECIFICATIONS
Group A Subgroup Testing
DC Characteristics

Parameter	Subgroups
V_{OH}	1, 2, 3
V_{OL}	1, 2, 3
V_{IH}	1, 2, 3
V_{IL}	1, 2, 3
I_{IX}	1, 2, 3
I_{OZ}	1, 2, 3
I_{CC}	1, 2, 3

Switching Characteristics

Parameter	Subgroups
t_{PD}	9, 10, 11
t_{PZX}	9, 10, 11
t_{CO}	9, 10, 11
t_S	9, 10, 11
t_H	9, 10, 11

Document #: 38-00019-G