

N-Channel Enhancement Mode MOSFET

Features

- 20V/40A,
 $R_{DS(ON)} = 12m\Omega$ (typ.) @ $V_{GS} = 4.5V$
 $R_{DS(ON)} = 20m\Omega$ (typ.) @ $V_{GS} = 2.5V$
- Super High Dense Cell Design
- Reliable and Rugged
- Lead Free and Green Devices Available
 (RoHS Compliant)

Applications

- Power Management in Desktop Computer or DC/DC Converters

Pin Description

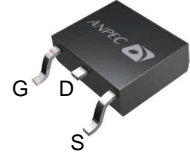

Top View of TO-252

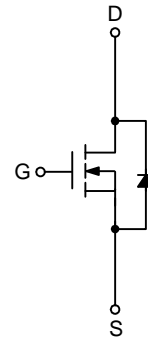

N-Channel MOSFET

Ordering and Marking Information

<p>APM2016N □□-□□ □</p> <ul style="list-style-type: none"> □ Assembly Material □□ Handling Code □□ Temperature Range □□□ Package Code 	<p>Package Code U : TO-252</p> <p>Operating Junction Temperature Range C : -55 to 150 °C</p> <p>Handling Code TR : Tape & Reel</p> <p>Assembly Material L : Lead Free Device G : Halogen and Lead Free Device</p>
<p>APM2016N U :</p> <div style="border: 1px solid black; padding: 2px; display: inline-block;">  <p>APM2016N XXXXX</p> </div>	<p>XXXXX - Date Code</p>

Note: ANPEC lead-free products contain molding compounds/die attach materials and 100% matte tin plate termination finish; which are fully compliant with RoHS. ANPEC lead-free products meet or exceed the lead-free requirements of IPC/JEDEC J-STD-020C for MSL classification at lead-free peak reflow temperature. ANPEC defines "Green" to mean lead-free (RoHS compliant) and halogen free (Br or Cl does not exceed 900ppm by weight in homogeneous material and total of Br and Cl does not exceed 1500ppm by weight).

ANPEC reserves the right to make changes to improve reliability or manufacturability without notice, and advise customers to obtain the latest version of relevant information to verify before placing orders.

Absolute Maximum Ratings

Symbol	Parameter	Rating	Unit	
Common Ratings ($T_A=25^{\circ}\text{C}$ Unless Otherwise Noted)				
V_{DSS}	Drain-Source Voltage	20	V	
V_{GSS}	Gate-Source Voltage	± 16		
T_J	Maximum Junction Temperature	150	$^{\circ}\text{C}$	
T_{STG}	Storage Temperature Range	-55 to 150	$^{\circ}\text{C}$	
I_S	Diode Continuous Forward Current	3.5	A	
Mounted on Large Heat Sink				
I_{DP}	300 μs Pulse Drain Current Tested	$T_C=25^{\circ}\text{C}$	120	A
		$T_C=100^{\circ}\text{C}$	100	
I_D	Continuous Drain Current	$T_C=25^{\circ}\text{C}$	40*	A
		$T_C=100^{\circ}\text{C}$	30	
P_D	Maximum Power Dissipation	$T_C=25^{\circ}\text{C}$	50	W
		$T_C=100^{\circ}\text{C}$	20	
$R_{\theta JC}$	Thermal Resistance-Junction to Case	2.5	$^{\circ}\text{C}/\text{W}$	
Mounted on PCB of 1in² pad area				
I_{DP}	300 μs Pulse Drain Current Tested	$T_A=25^{\circ}\text{C}$	40	A
		$T_A=100^{\circ}\text{C}$	24	
I_D	Continuous Drain Current	$T_A=25^{\circ}\text{C}$	10	A
		$T_A=100^{\circ}\text{C}$	6	
P_D	Maximum Power Dissipation	$T_A=25^{\circ}\text{C}$	2.5	W
		$T_A=100^{\circ}\text{C}$	1	
$R_{\theta JA}$	Thermal Resistance-Junction to Ambient	50	$^{\circ}\text{C}/\text{W}$	
Mounted on PCB of Minimum Footprint				
I_{DP}	300 μs Pulse Drain Current Tested	$T_A=25^{\circ}\text{C}$	32	A
		$T_A=100^{\circ}\text{C}$	20	
I_D	Continuous Drain Current	$T_A=25^{\circ}\text{C}$	8	A
		$T_A=100^{\circ}\text{C}$	5	
P_D	Maximum Power Dissipation	$T_A=25^{\circ}\text{C}$	1.6	W
		$T_A=100^{\circ}\text{C}$	0.6	
$R_{\theta JA}$	Thermal Resistance-Junction to Ambient	75	$^{\circ}\text{C}/\text{W}$	

Notes:

* Current limited by bond wire

Electrical Characteristics (T_A = 25°C unless otherwise noted)

Symbol	Parameter	Test Conditions	APM2016NU			Unit
			Min.	Typ.	Max.	
Static Characteristics						
BV _{DSS}	Drain-Source Breakdown Voltage	V _{GS} =0V, I _{DS} =250μA	20	-	-	V
I _{DSS}	Zero Gate Voltage Drain Current	V _{DS} =16V, V _{GS} =0V	-	-	1	μA
		T _J =85°C	-	-	30	
V _{GS(th)}	Gate Threshold Voltage	V _{DS} =V _{GS} , I _{DS} =250μA	0.6	0.9	1.5	V
I _{GSS}	Gate Leakage Current	V _{GS} =±16V, V _{DS} =0V	-	-	±100	nA
R _{DS(ON)} ^a	Drain-Source On-state Resistance	V _{GS} =4.5V, I _{DS} =20A	-	12	14	mΩ
		V _{GS} =2.5V, I _{DS} =10A	-	20	30	
Diode Characteristics						
V _{SD} ^a	Diode Forward Voltage	I _{SD} =3.5A, V _{GS} =0V	-	0.8	1.3	V
Gate Charge Characteristics^b						
Q _g	Total Gate Charge	V _{DS} =10V, V _{GS} =4.5V, I _{DS} =20A	-	12	17	nC
Q _{gs}	Gate-Source Charge		-	2.2	-	
Q _{gd}	Gate-Drain Charge		-	7	-	
Dynamic Characteristics^b						
R _G	Gate Resistance	V _{GS} =V _{DS} =0V, F=1MHz	-	1.6	-	Ω
C _{iss}	Input Capacitance	V _{GS} =0V, V _{DS} =10V, Frequency=1.0MHz	-	1052	-	pF
C _{oss}	Output Capacitance		-	270	-	
C _{rss}	Reverse Transfer Capacitance		-	195	-	
t _{d(ON)}	Turn-on Delay Time	V _{DD} =10V, R _L =10Ω, I _{DS} =1A, V _{GEN} =4.5V, R _G =6Ω	-	14	26	ns
t _r	Turn-on Rise Time		-	22	41	
t _{d(OFF)}	Turn-off Delay Time		-	40	73	
t _f	Turn-off Fall Time		-	13	24	
t _{rr}	Reverse Recovery Time	I _{SD} =3.5A, dI _{SD} /dt=100A/μs	-	12	-	ns
Q _{rr}	Reverse Recovery Charge		-	3	-	nC

Notes:

a : Pulse test ; pulse width≤300μs, duty cycle≤2%.

b : Guaranteed by design, not subject to production testing.

Typical Characteristics

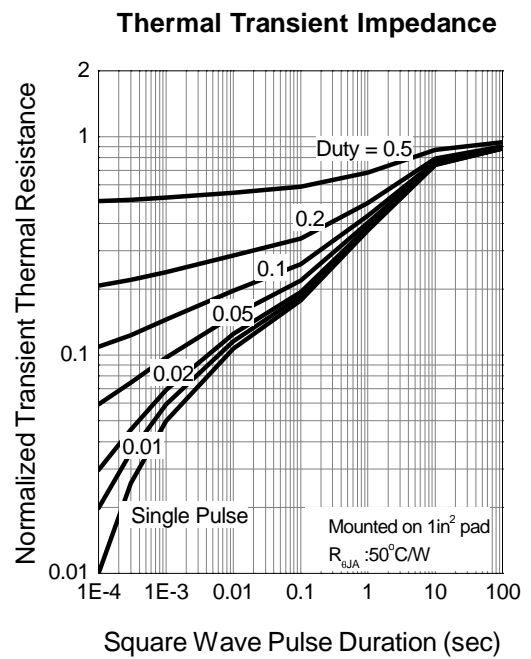
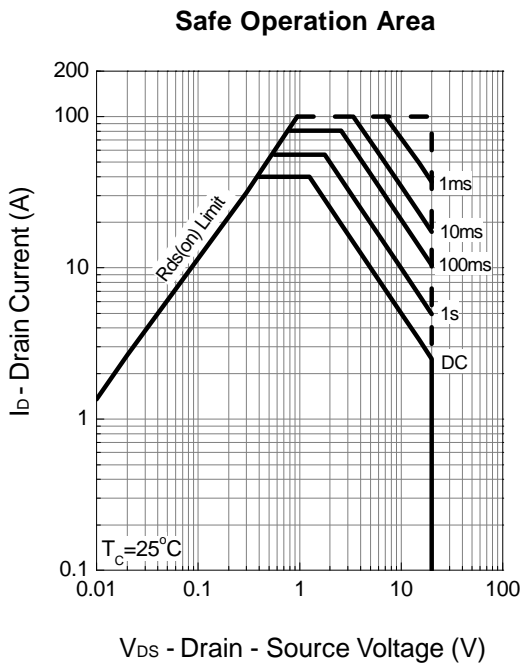
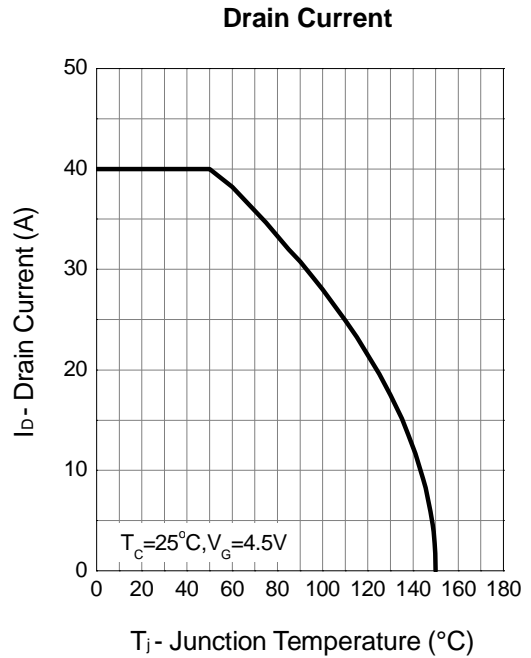
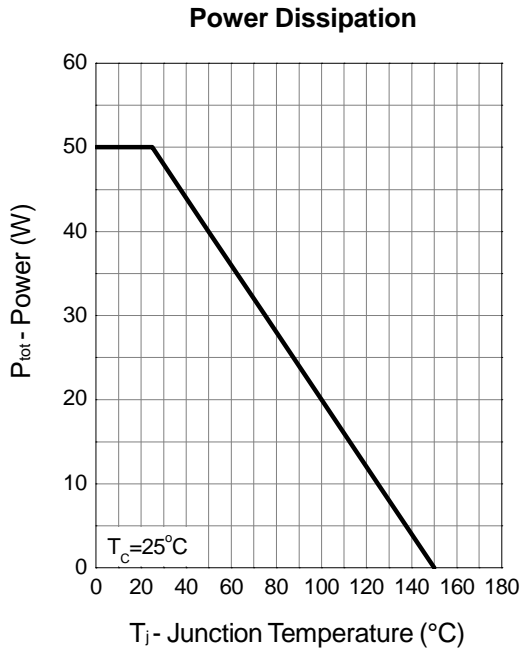

Typical Characteristics (Cont.)

Output Characteristics

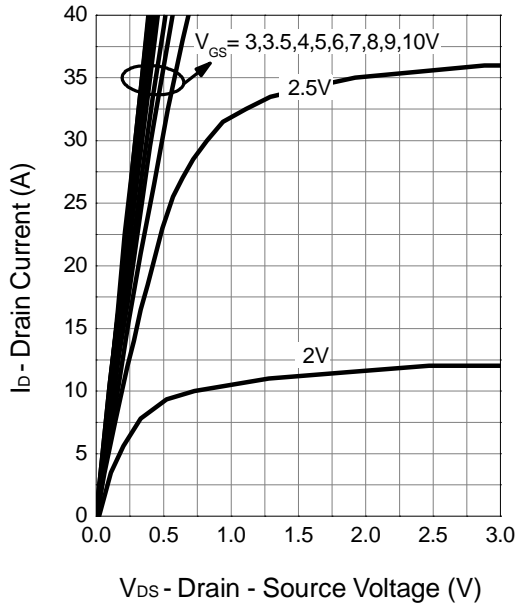

Drain-Source On Resistance

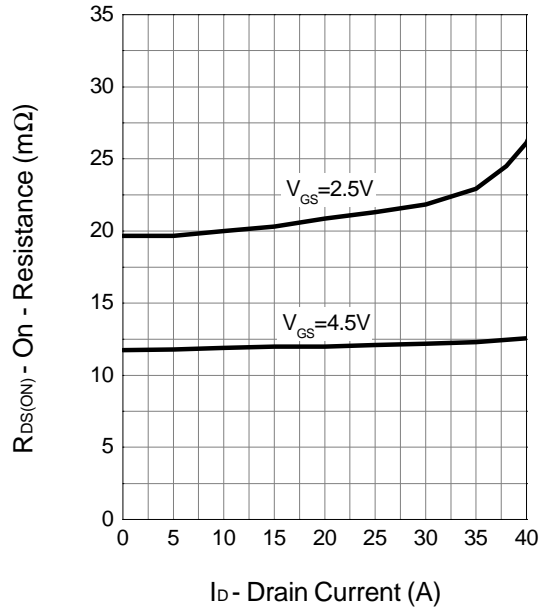

Drain-Source On Resistance

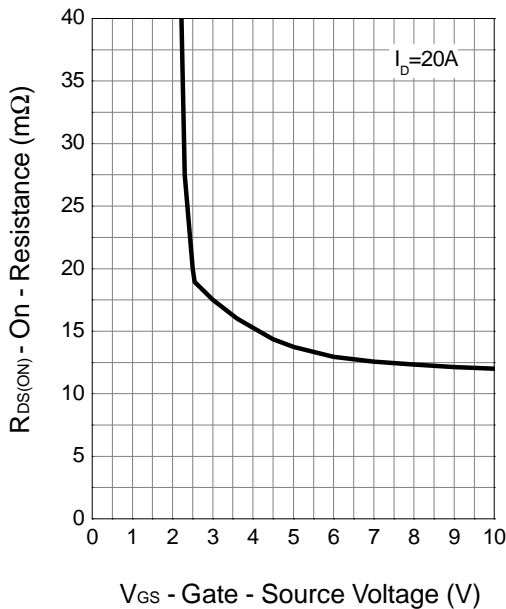

Gate Threshold Voltage

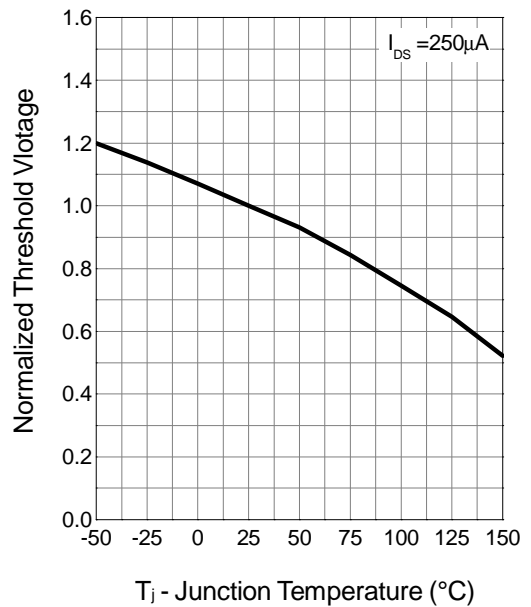

Typical Characteristics (Cont.)

Drain-Source On Resistance

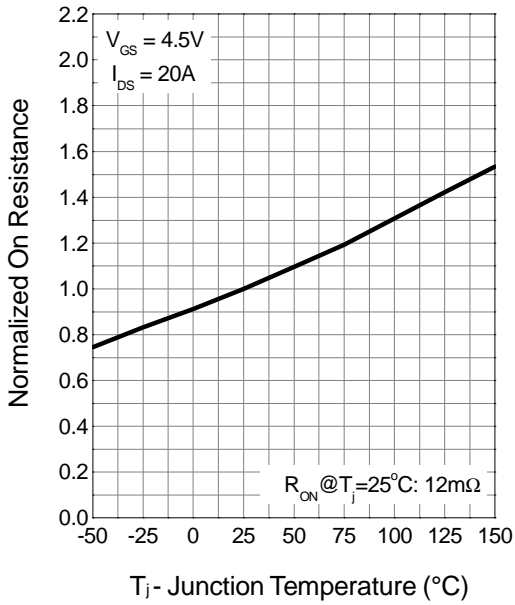

Source-Drain Diode Forward

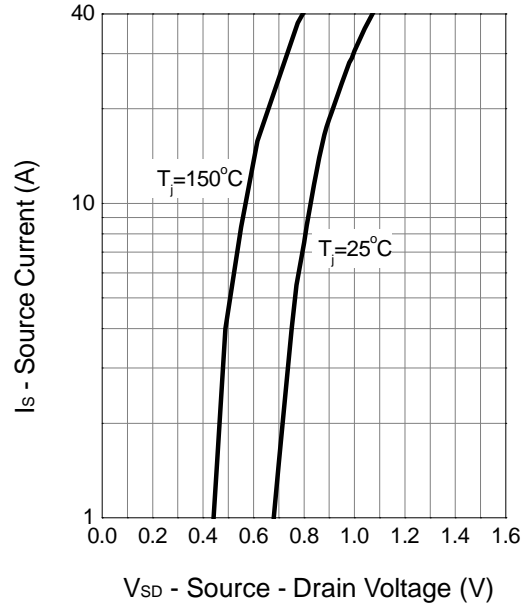

Capacitance

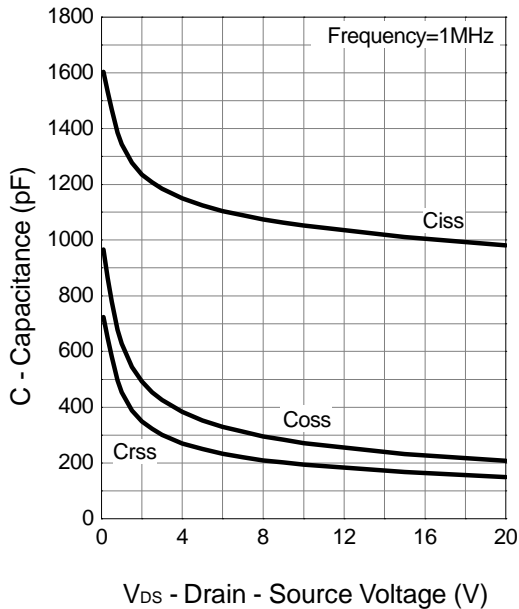

Gate Charge

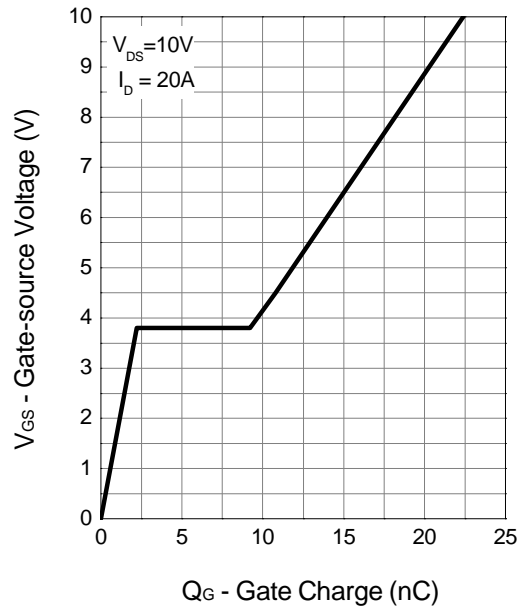

Package Information

TO-252-3

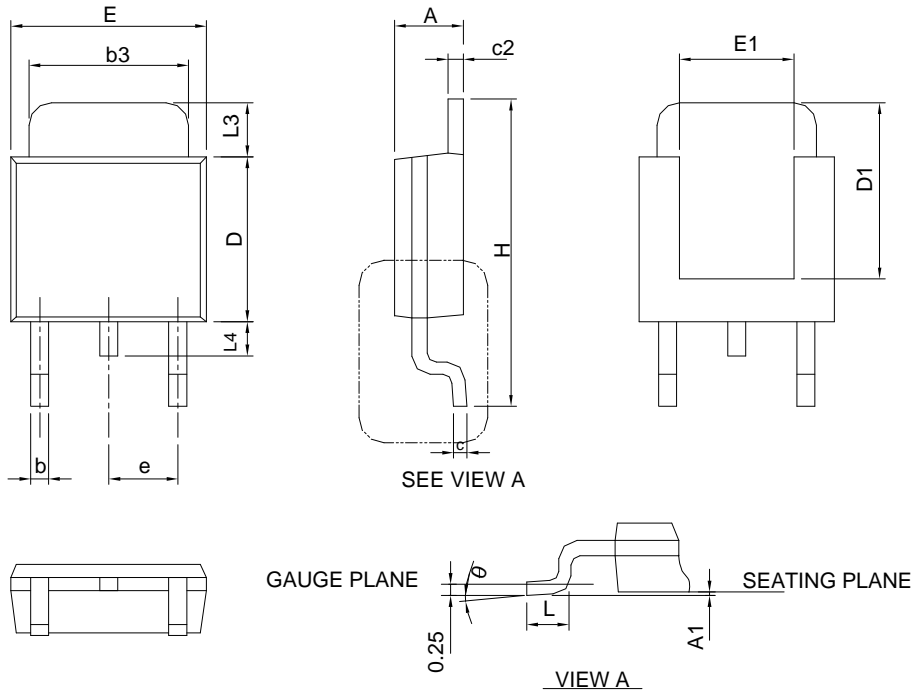

SYMBOL	TO-252-3			
	MILLIMETERS		INCHES	
	MIN.	MAX.	MIN.	MAX.
A	2.18	2.39	0.086	0.094
A1		0.13		0.005
b	0.50	0.89	0.020	0.035
b3	4.95	5.46	0.195	0.215
c	0.46	0.61	0.018	0.024
c2	0.46	0.89	0.018	0.035
D	5.33	6.22	0.210	0.245
D1	4.57	6.00	0.180	0.236
E	6.35	6.73	0.250	0.265
E1	3.81	6.00	0.150	0.236
e	2.29 BSC		0.090 BSC	
H	9.40	10.41	0.370	0.410
L	0.90	1.78	0.035	0.070
L3	0.89	2.03	0.035	0.080
L4		1.02		0.040
θ	0°	8°	0°	8°

Note : Follow JEDEC TO-252 .

Carrier Tape & Reel Dimensions

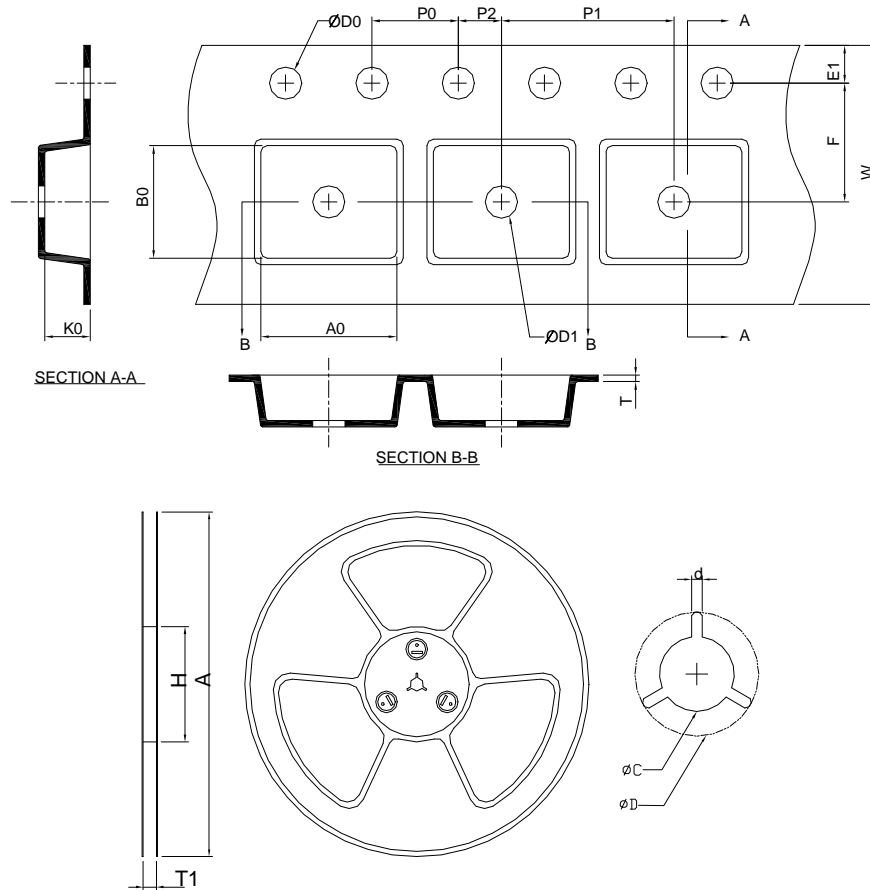

Application	A	H	T1	C	d	D	W	E1	F
TO-252-3	330.0 ± 2.00	50 MIN.	16.4+2.00 -0.00	13.0+0.50 -0.20	1.5 MIN.	20.2 MIN.	16.0 ±0.30	1.75 ±0.10	7.50 ±0.05
	P0	P1	P2	D0	D1	T	A0	B0	K0
	4.0 ±0.10	8.0 ±0.10	2.0 ±0.05	1.5+0.10 -0.00	1.5 MIN.	0.6+0.00 -0.40	6.80 ±0.20	10.40 ± 0.20	2.50 ±0.20

(mm)

Devices Per Unit

Package Type	Unit	Quantity
To-252-3	Tape & Reel	2500

Taping Direction Information

TO-252-3

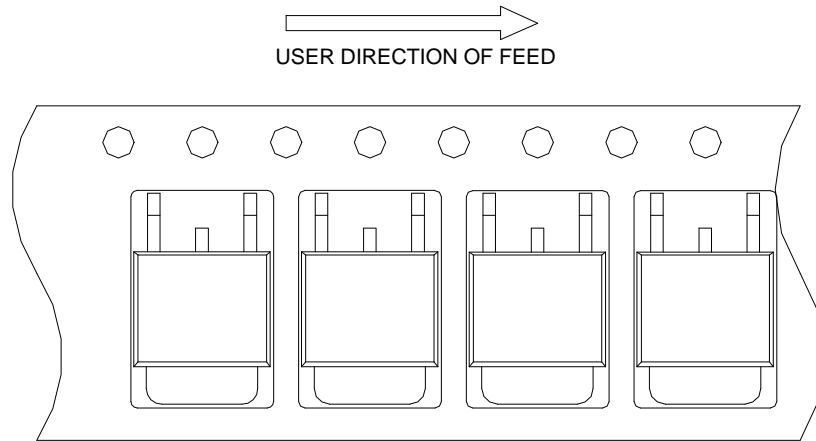

Reflow Condition (IR/Convection or VPR Reflow)

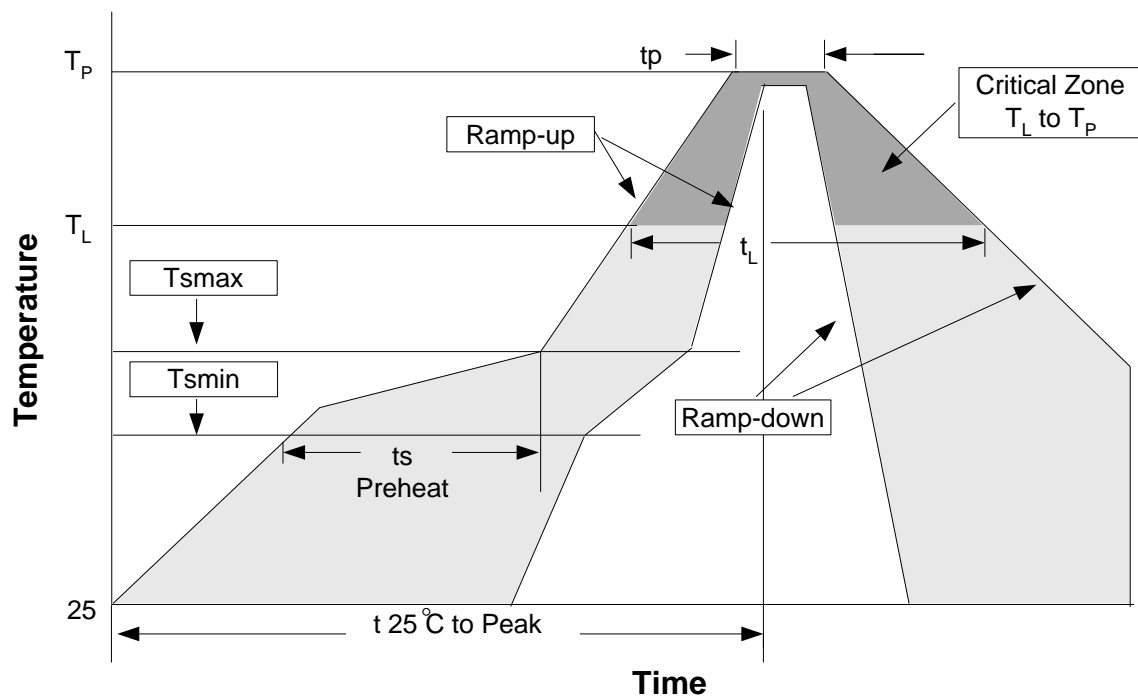

Reliability Test Program

Test item	Method	Description
SOLDERABILITY	MIL-STD-883D-2003	245°C, 5 sec
HOLT	MIL-STD-883D-1005.7	1000 Hrs Bias @125°C
PCT	JESD-22-B, A102	168 Hrs, 100%RH, 121°C
TST	MIL-STD-883D-1011.9	-65°C~150°C, 200 Cycles
ESD	MIL-STD-883D-3015.7	VHBM > 2KV, VMM > 200V
Latch-Up	JESD 78	10ms, 1 _{tr} > 100mA

Classification Reflow Profiles

Profile Feature	Sn-Pb Eutectic Assembly	Pb-Free Assembly
Average ramp-up rate (T _L to T _P)	3°C/second max.	3°C/second max.
Preheat		
- Temperature Min (T _{min})	100°C	150°C
- Temperature Max (T _{max})	150°C	200°C
- Time (min to max) (ts)	60-120 seconds	60-180 seconds
Time maintained above:		
- Temperature (T _L)	183°C	217°C
- Time (t _L)	60-150 seconds	60-150 seconds
Peak/Classification Temperature (T _p)	See table 1	See table 2
Time within 5°C of actual Peak Temperature (t _p)	10-30 seconds	20-40 seconds
Ramp-down Rate	6°C/second max.	6°C/second max.
Time 25°C to Peak Temperature	6 minutes max.	8 minutes max.

Note: All temperatures refer to topside of the package. Measured on the body surface.

Table 1. SnPb Eutectic Process – Package Peak Reflow Temperatures

Package Thickness	Volume mm ³ <350	Volume mm ³ ≈350
<2.5 mm	240 +0/-5°C	225 +0/-5°C
≥2.5 mm	225 +0/-5°C	225 +0/-5°C

Table 2. Pb-free Process – Package Classification Reflow Temperatures

Package Thickness	Volume mm ³ <350	Volume mm ³ 350-2000	Volume mm ³ >2000
<1.6 mm	260 +0°C*	260 +0°C*	260 +0°C*
1.6 mm – 2.5 mm	260 +0°C*	250 +0°C*	245 +0°C*
≥2.5 mm	250 +0°C*	245 +0°C*	245 +0°C*

*Tolerance: The device manufacturer/supplier **shall** assure process compatibility up to and including the stated classification temperature (this means Peak reflow temperature +0°C. For example 260°C+0°C) at the rated MSL level.

Customer Service

Anpec Electronics Corp.

Head Office :

No.6, Dusing 1st Road, SBIP,

Hsin-Chu, Taiwan, R.O.C.

Tel : 886-3-5642000

Fax : 886-3-5642050

Taipei Branch :

2F, No. 11, Lane 218, Sec 2 Jhongsing Rd.,

Sindain City, Taipei County 23146, Taiwan

Tel : 886-2-2910-3838

Fax : 886-2-2917-3838