

NUMBER
175196

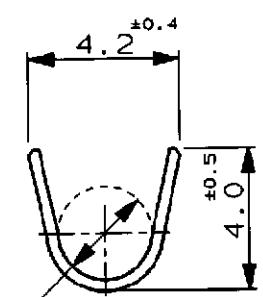

METRIC

ワイヤレンジ
WIRE RANGE
ID MARK

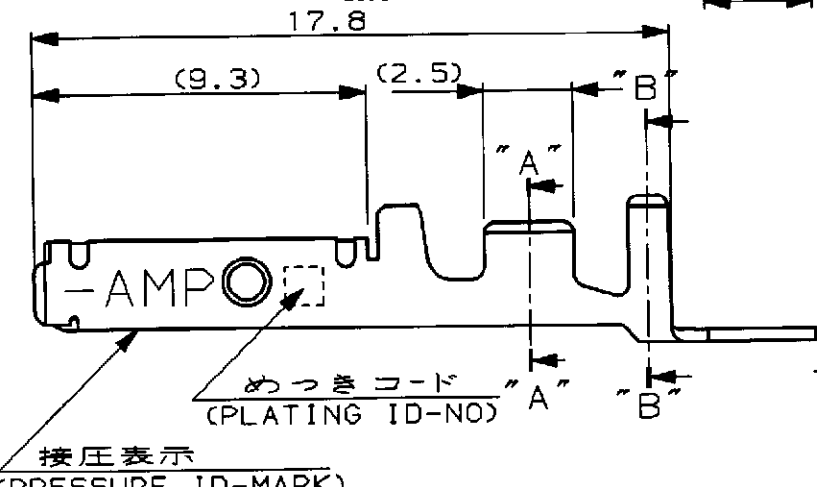
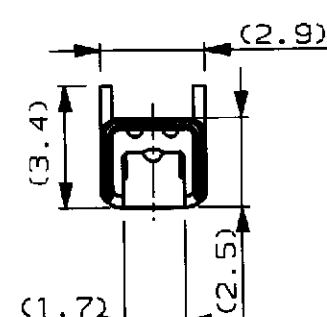
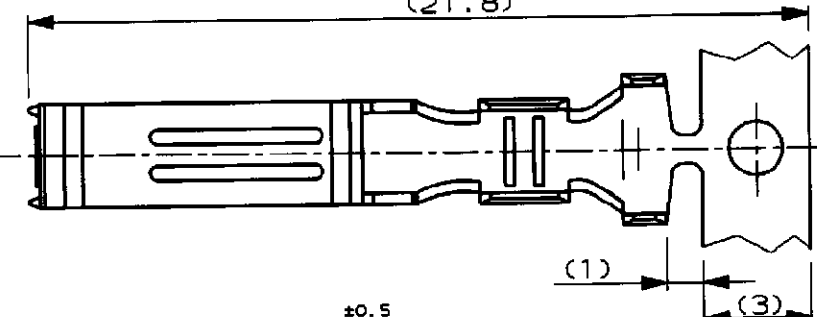
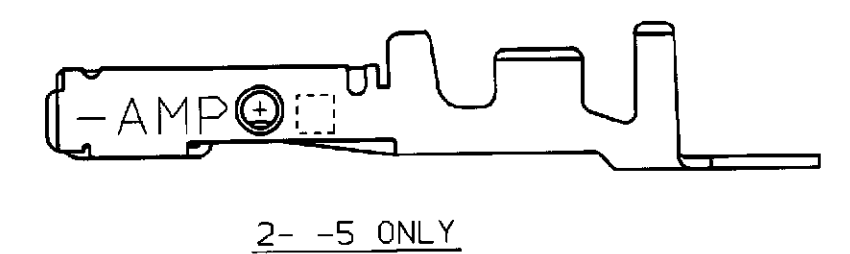
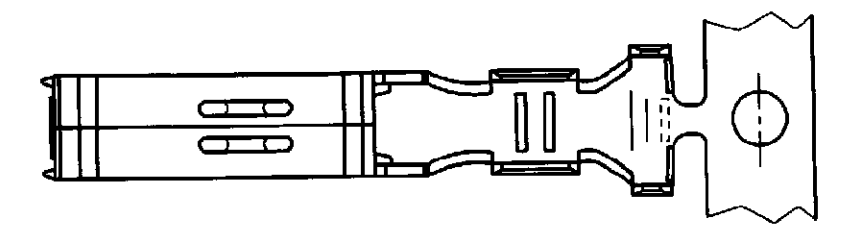
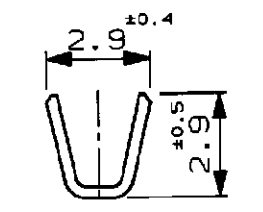
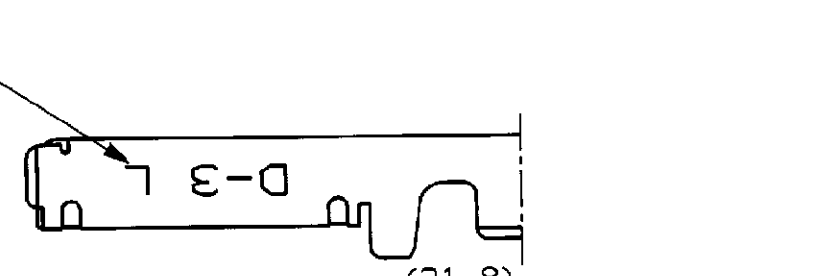

注記

- △ 標準接圧型コンタクト：一般向け及び多極用
- △ 高接圧型コンタクト：高電流用及び強振動用
- △ 金めっきは接触部のみとする
- 4 製品規格：108-5349
- 5 取付け適用規格：114-5148

NOTES

- △ CONTACT TYPE, LOW PRESSURE TYPE (FOR GENERAL)
- △ CONTACT TYPE, HIGH PRESSURE TYPE (FOR HIGH CURRENT OR ANTI-VIBRATION)
- △ GOLD-PL. CONTACT AREA ONLY
- 4 PRODUCT SPEC: 108-5349
- 5 APPLICATION SPEC: 114-5148

備考 (REMARK)	接圧表示 (ID-MARK)	めっきコード (PL. ID NO)	仕上 (FINISH)	型番 (P/N)
△	H	5	光沢錫めっき (BRIGHT TIN-PL.)	2- -5
△	H	5	光沢錫めっき (BRIGHT TIN-PL.)	1- -5
△	H	3	0.76μm最小金めっき (0.76μmMIN. Au-PL.)	1- -3
△	H	2	0.38μm最小金めっき (0.38μmMIN. Au-PL.)	1- -2
△	OBSOLETE	5	光沢錫めっき (BRIGHT TIN-PL.)	-5
△	OBSOLETE	3	0.76μm最小金めっき (0.76μmMIN. Au-PL.)	-3
△	OBSOLETE	2	0.38μm最小金めっき (0.38μmMIN. Au-PL.)	175196-2

U. 855-111>U. DM6>S. C89-25173
単位: mm DIMENSIONS IN MM. DO NOT SCALE PRINT

PRINT DIST

Copyright ©1990 年 AMP (Japan), LTD. ALL RIGHTS RESERVED.

Copyright ©1990 年 AMP (Japan), LTD. ALL RIGHTS RESERVED.

AMP

日本エー・エム・ピー株式会社
Kawasaki, Japan

B REVISION (REVISION RECORD)	DR	CHK	DATE	適合電線断面積 (WIRE RANGE) AWG 20-16 (0.5-1.25mm ²)	被覆外径 (INSULATION DIA.) 1.8-2.8 mmφ	名称 (NAME) "L" SIZE ダイナミックシリーズリセプタクルコンタクト	一般公差 (GENERAL TOLERANCE) 10mm以下: ±0.2 10mm以上 30mm以下: ±0.25 30mm以上 100mm以下: ±0.3 角 度: ±3°	尺寸 (SCALE) B J 5-1	番号 (No.) REV. SHEET B 175196 1 OF 1
------------------------------	----	-----	------	---	---------------------------------------	--	--	--------------------------	---

参考 ☒ 面