

# HLMP-ALxx/BLxx/ADxx/BDxx/BB11/BM11 T-1<sup>3</sup>/<sub>4</sub> (5 mm) Oval Precision Optical Performance AlInGaP and InGaN Lamps



## Data Sheet



### Description

These Precision Optical Performance Oval LEDs are specifically designed for full color/video and passenger information signs. The oval shaped radiation pattern (35° x 70°) and high luminous intensity ensure that these devices are excellent for wide field of view outdoor application where a wide viewing angle and readability in sunlight are essential. These lamps have very smooth, matched radiation patterns ensuring consistent color mixing in full color applications, message uniformity across the viewing angle of the sign.

High efficiency LED material is used in these lamps: Aluminum Indium Gallium Phosphide (AlInGaP) for amber and red, and Indium Gallium Nitride (InGaN) for blue and green. Each lamp is made with an advance optical grade epoxy offering superior high temperature and high moisture resistance in outdoor applications. The package epoxy contains both UV-A and UV-B inhibitors to reduce the effects of long term exposure to direct sunlight.

Designers can select parallel or perpendicular orientation. Both lamps are available in tinted version.

### Features

- Well defined spatial radiation pattern
- Viewing angles:  
Major axis 70°  
Minor axis 35°
- High luminous output
- Red and Amber intensity are available for:  
AlInGaP (Bright)  
AlInGaP II (Brightest)
- Colors:  
472 nm blue  
526 nm green  
626 nm red  
630 nm red  
590 nm amber  
592 nm amber
- Superior resistance to moisture
- UV resistant epoxy

### Benefits

- Viewing angle designed for wide field of view application
- Red, green, and blue radiation patterns matched for full color sign
- Superior performance in outdoor environments

### Applications

- Full color/video signs

*CAUTION: The blue and green LEDs are Class 1 ESD sensitive. Please observe appropriate precautions during handling and processing. Refer to Avago Application Note AN-1142 for additional details.*

**Table 1. Device Selection Guide for AlInGaP II**

Part Number	Color and Dominant Wavelength $\lambda_d$ (nm) Typ.	Luminous Intensity, $I_v$ (mcd) at 20 mA Min.	Luminous Intensity, $I_v$ (mcd) at 20 mA Max.	Forward Voltage, $V_f$ (V) Max.	Leads with Stand-offs	Leadframe Orientation	Package Drawing
HLMP-AD06-P00xx	Red 630	880		2.4	No	Parallel	A
HLMP-AD06-P0Txx	Red 630	880		2.6	No	Parallel	A
HLMP-AD16-P00xx	Red 630	880		2.4	Yes	Parallel	B
HLMP-AD16-P0Txx	Red 630	880		2.6	Yes	Parallel	B
HLMP-AD16-RS0xx	Red 630	1500	2500	2.6	Yes	Parallel	B
HLMP-AD16-RSTxx	Red 630	1500	2500	2.6	Yes	Parallel	B
HLMP-AD16-RU0xx	Red 630	1500	4200	2.4	Yes	Parallel	B
HLMP-AD16-RUTxx	Red 630	1500	4200	2.6	Yes	Parallel	B
HLMP-AD16-ST0xx	Red 630	1900	3200	2.4	Yes	Parallel	B
HLMP-AD16-STTxx	Red 630	1900	3200	2.6	Yes	Parallel	B
HLMP-AL06-L00xx	Amber 592	400		2.4	No	Parallel	A
HLMP-AL06-L0Rxx	Amber 592	400		2.6	No	Parallel	A
HLMP-AL06-N00xx	Amber 592	680		2.4	No	Parallel	A
HLMP-AL06-N0Rxx	Amber 592	680		2.6	No	Parallel	A
HLMP-AL16-N00xx	Amber 592	680		2.4	Yes	Parallel	B
HLMP-AL16-N0Rxx	Amber 592	680		2.6	Yes	Parallel	B
HLMP-AL16-PSRxx	Amber 592	880	2500	2.6	Yes	Parallel	B
HLMP-AL16-QR0xx	Amber 592	1150	1900	2.4	Yes	Parallel	B
HLMP-AL16-QRRxx	Amber 592	1150	1900	2.6	Yes	Parallel	B
HLMP-BD06-P00xx	Red 630	880		2.4	No	Perpendicular	C
HLMP-BD06-P0Txx	Red 630	880		2.6	No	Perpendicular	C
HLMP-BD06-RS0xx	Red 630	1500	2500	2.4	No	Perpendicular	C
HLMP-BD06-RSTxx	Red 630	1500	2500	2.6	No	Perpendicular	C
HLMP-BD16-P00xx	Red 630	880		2.4	Yes	Perpendicular	D
HLMP-BD16-P0Txx	Red 630	880		2.6	Yes	Perpendicular	D
HLMP-BD16-RU0xx	Red 630	1500	4200	2.4	Yes	Perpendicular	D
HLMP-BD16-RUTxx	Red 630	1500	4200	2.6	Yes	Perpendicular	D
HLMP-BD16-ST0xx	Red 630	1900	3200	2.4	Yes	Perpendicular	D
HLMP-BD16-STTxx	Red 630	1900	3200	2.6	Yes	Perpendicular	D
HLMP-BL06-N00xx	Amber 592	680		2.4	No	Perpendicular	C
HLMP-BL06-N0Rxx	Amber 592	680		2.6	No	Perpendicular	C
HLMP-BL06-QRKxx	Amber 592	1150	1900	2.4	No	Perpendicular	C
HLMP-BL06-QRSxx	Amber 592	1150	1900	2.6	No	Perpendicular	C
HLMP-BL16-N00xx	Amber 592	680		2.4	Yes	Perpendicular	D
HLMP-BL16-N0Rxx	Amber 592	680		2.6	Yes	Perpendicular	D
HLMP-BL16-PS0xx	Amber 592	880	2500	2.4	Yes	Perpendicular	D
HLMP-BL16-PSRxx	Amber 592	880	2500	2.6	Yes	Perpendicular	D

**Table 2. LED Indicators**  
**Device Selection Guide for AlInGaP**

<b>Part Number</b>	<b>Color and Dominant Wavelength <math>\lambda_d</math> (nm) Typ.</b>	<b>Luminous Intensity, <math>I_v</math> (mcd) at 20 mA Min.</b>	<b>Luminous Intensity, <math>I_v</math> (mcd) at 20 mA Max.</b>	<b>Leads with Stand-offs</b>	<b>Leadframe Orientation</b>	<b>Package Drawing</b>
HLMP-AG01-K00xx	Red 626	310		No	Parallel	A
HLMP-AG11-KN0xx	Red 626	310	880	Yes	Parallel	B
HLMP-AL01-K00xx	Amber 590	310		No	Parallel	A
HLMP-AL01-LP0xx	Amber 590	400	1150	No	Parallel	A
HLMP-AL01-NR0xx	Amber 590	680	1900	No	Parallel	A
HLMP-AL11-KN0xx	Amber 590	310	880	Yes	Parallel	B
HLMP-AL11-NR0xx	Amber 590	680	1900	Yes	Parallel	B
HLMP-BG01-LM0xx	Red 626	400	520	No	Perpendicular	C
HLMP-BG01-MN0xx	Red 626	520	880	No	Perpendicular	C
HLMP-BG11-KN0xx	Red 626	310	880	Yes	Perpendicular	D
HLMP-BL01-NR0xx	Amber 590	680	1900	No	Perpendicular	C
HLMP-BL11-KN0xx	Amber 590	310	880	Yes	Perpendicular	D
HLMP-BL11-NR0xx	Amber 590	680	1900	Yes	Perpendicular	D

**Table 3. Device Selection Guide for InGaN**

<b>Part Number</b>	<b>Color and Dominant Wavelength <math>\lambda_d</math> (nm) Typ.</b>	<b>Luminous Intensity, <math>I_v</math> (mcd) at 20 mA Min.</b>	<b>Leads with Stand-offs</b>	<b>Leadframe Orientation</b>	<b>Package Drawing</b>
HLMP-AB01-J00xx	Blue 472	240	No	Parallel	A
HLMP-AB01-K0Dxx	Blue 472	310	No	Parallel	A
HLMP-BB11-J00xx	Blue 472	240	Yes	Perpendicular	D
HLMP-BB11-K00xx	Blue 472	310	Yes	Perpendicular	D
HLMP-BM11-L00xx	Green 526	400	Yes	Perpendicular	D
HLMP-BM11-Q00xx	Green 526	1150	Yes	Perpendicular	D
HLMP-AB11-J00xx	Blue 472	240	Yes	Parallel	B
HLMP-AM01-Q00xx	Green 526	1150	No	Parallel	A
HLMP-BB01-J0Bxx	Blue 472	240	No	Perpendicular	C
HLMP-BB11-KN0xx	Blue 472	310	Yes	Perpendicular	D
HLMP-BM01-L00xx	Green 526	400	No	Perpendicular	C

Tolerance for intensity range limit is  $\pm 15\%$ .

## Part Numbering System

HLMP-X X X X - X X X XX

### Mechanical Options

00: Bulk Packaging  
DD: Ammo Pack  
YY: Flexi-Bin; Bulk Packaging  
ZZ: Flexi-Bin; Ammo Pack

### Color Bin

0: No Color Bin Limitation  
B: Color bin 2 and 3 only  
K: Color bins 2 and 4 only  
R: Color Bins 1, 2, 4, and 6 with  $V_F$  max of 2.6 V  
S: Color bins 2 and 4 with  $V_F$  max of 2.6 V  
T: Red Color with  $V_F$  max of 2.6 V

### Maximum Intensity Bin

0: No Iv Bin Limitation

### Minimum Intensity Bin

### Tint Option

1 or 6: Matching Color Tints

### Standoff Option

0: Without  
1: With

### Color

B: 472 nm Blue  
D: 630 nm Red  
G: 626 nm Red  
L: 590 or 592 nm Amber  
M: 526 nm Green

### Package

A: 5 mm Mini Oval, Parallel  
B: 5 mm Mini Oval, Perpendicular

## Package Dimensions

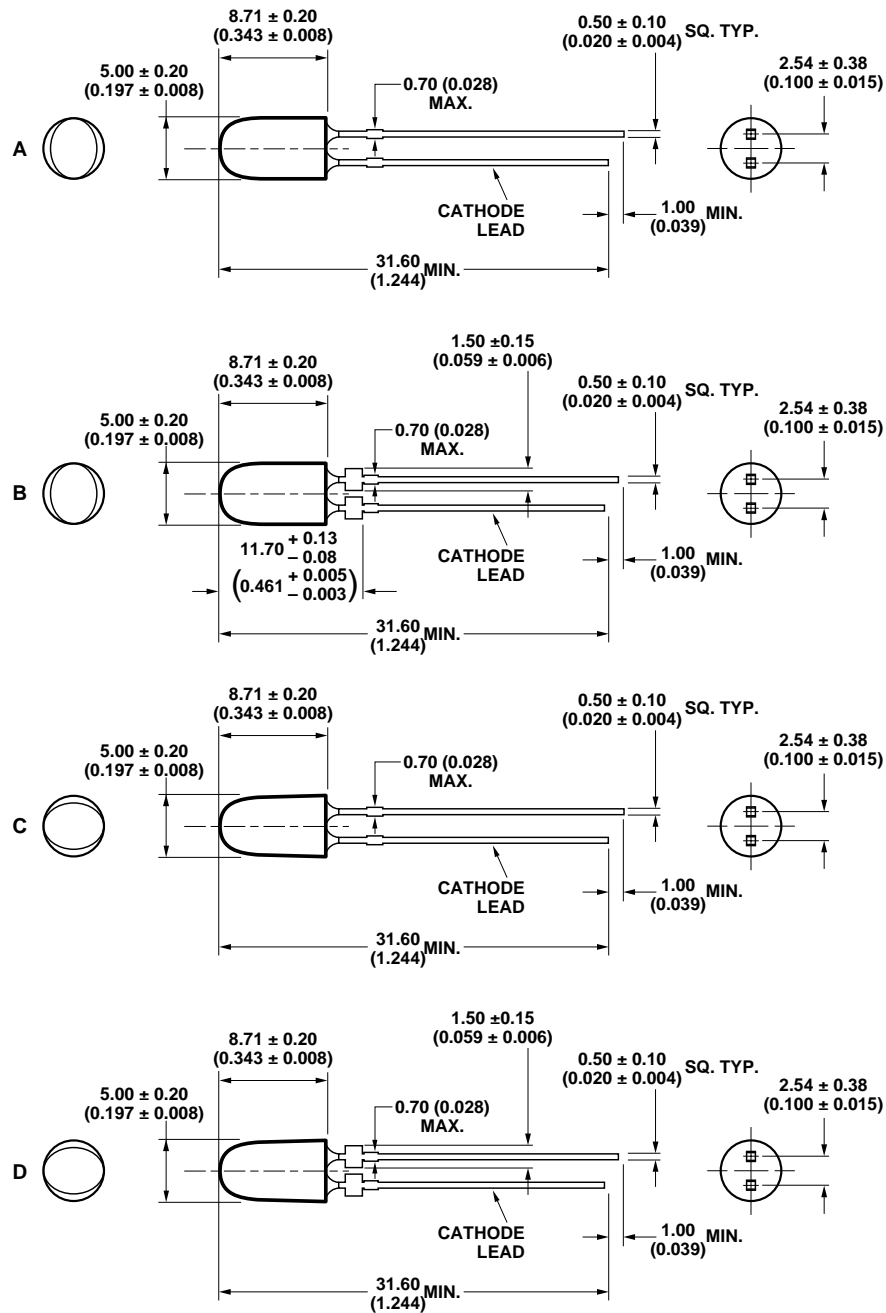

### NOTES:

- ALL DIMENSIONS ARE IN MILLIMETERS (INCHES).
- LEADS ARE MILD STEEL, SOLDER DIPPED.
- TAPERS SHOWN AT TOP OF LEADS (BOTTOM OF LAMP PACKAGE) INDICATE AN EPOXY MENISCUS THAT MAY EXTEND ABOUT 1 mm (0.040 IN.) DOWN THE LEADS.
- RECOMMENDED PC BOARD HOLE DIAMETERS:
  - LAMP PACKAGES A AND C WITHOUT STAND-OFFS: FLUSH MOUNTING AT BASE OF LAMP PACKAGE = 1.143/1.067 mm (0.044/0.042 IN.).
  - LAMP PACKAGES B AND D WITH STAND-OFFS: MOUNTING AT LEAD STAND-OFFS.

**Absolute Maximum Ratings at  $T_A = 25^\circ\text{C}$** 

Parameter	Blue and Green	Red and Amber
DC Forward Current <sup>[1]</sup>	30 mA	50 mA
Peak Pulsed Forward Current <sup>[2]</sup>	100 mA	100 mA
Average Forward Current	30 mA	30 mA
Reverse Voltage ( $I_R = 100 \mu\text{A}$ )		5 V
Reverse Voltage ( $I_R = 10 \mu\text{A}$ )	5 V	
Power Dissipation	120 mW	120 mW
LED Junction Temperature	130°C	130°C
Operating Temperature Range	-40°C to +80°C	-40°C to +100°C
Storage Temperature Range	-40°C to +100°C	-40°C to +120°C
Dip Soldering Temperature <sup>[3]</sup>	260°C for 5 seconds	260°C for 5 seconds
Wave Soldering Temperature <sup>[3]</sup>	250°C for 3 seconds	250°C for 3 seconds

**Notes:**

1. Derate linearly from Figure 7.
2. Duty Factor 30% KHz.
3. 1.59 mm (0.060 in.) below body.

**Electrical/Optical Characteristics at T<sub>A</sub> = 25°C**

Parameter	Symbol	Min.	Typ.	Max.	Units	Test Conditions
Typical Viewing Angle						
Major	2θ <sub>1/2</sub>		70		deg	
Minor			35			
Forward Voltage	V <sub>F</sub>				V	I <sub>F</sub> = 20 mA
Red (λ <sub>d</sub> = 626 nm)			2.0	2.4		
Red (λ <sub>d</sub> = 630 nm)						
Option xx0xx			2.2	2.4		
Option xxTxx			2.3	2.6		
Amber (λ <sub>d</sub> = 590 nm)			2.0	2.4		
Amber (λ <sub>d</sub> = 592 nm)						
Option xx0xx			2.2	2.4		
Option xxRxx, xxSxx			2.3	2.6		
Blue (λ <sub>d</sub> = 472 nm)			3.5	4.0		
Green (λ <sub>d</sub> = 526 nm)			3.5	4.0		
Reverse Voltage						
Amber, Red	V <sub>R</sub>	5	20		V	I <sub>R</sub> = 100 μA
Blue, Green		5	–			
Peak Wavelength						
Amber (λ <sub>d</sub> = 592 nm)	λ <sub>peak</sub>		594		nm	Peak of Wavelength of Spectral Distribution at I <sub>F</sub> = 20 mA
Red (λ <sub>d</sub> = 630 nm)			639			
Blue (λ <sub>d</sub> = 472 nm)			470			
Green (λ <sub>d</sub> = 526 nm)			524			
Spectral Halfwidth						
Amber (λ <sub>d</sub> = 592 nm)	Δλ <sub>1/2</sub>		17		nm	Wavelength Width at Spectral Distribution 1/2 Power Point at I <sub>F</sub> = 20 mA
Red (λ <sub>d</sub> = 630 nm)			17			
Blue (λ <sub>d</sub> = 472 nm)			35			
Green (λ <sub>d</sub> = 526 nm)			47			
Capacitance						
Amber, Red	C		40		pF	V <sub>F</sub> = 0, F = 1 MHz
Blue, Green			43			
Luminous Efficacy						
Amber (λ <sub>d</sub> = 592 nm)	η <sub>v</sub>		500		lm/W	Emitted Luminous Power/Emitted Radiant Power at I <sub>F</sub> = 20 mA
Red (λ <sub>d</sub> = 630 nm)			155			
Blue (λ <sub>d</sub> = 472 nm)			75			
Green (λ <sub>d</sub> = 526 nm)			520			
Thermal Resistance	R <sub>ΘJ-PIN</sub>		240		°C/W	LED Junction-to-Cathode Lead

**Notes:**

1. 2θ<sub>1/2</sub> is the off-axis angle where the luminous intensity is 1/2 the on-axis intensity.
2. The radiant intensity, I<sub>e</sub> in watts per steradian, may be found from the equation I<sub>e</sub> = I<sub>v</sub>/η<sub>v</sub> where I<sub>v</sub> is the luminous intensity in candelas and η<sub>v</sub> is the luminous efficacy in lumens/watt.
3. The luminous intensity is measured on the mechanical axis of the lamp package.
4. The optical axis is closely aligned with the package mechanical axis.
5. The dominant wavelength, λ<sub>d</sub>, is derived from the CIE Chromaticity Diagram and represents the color of the lamp.
6. For Options -xxRxx, -xxSxx and -xxTxx, max. forward voltage (V<sub>F</sub>) is 2.6 V. Refer to V<sub>F</sub> bin table.

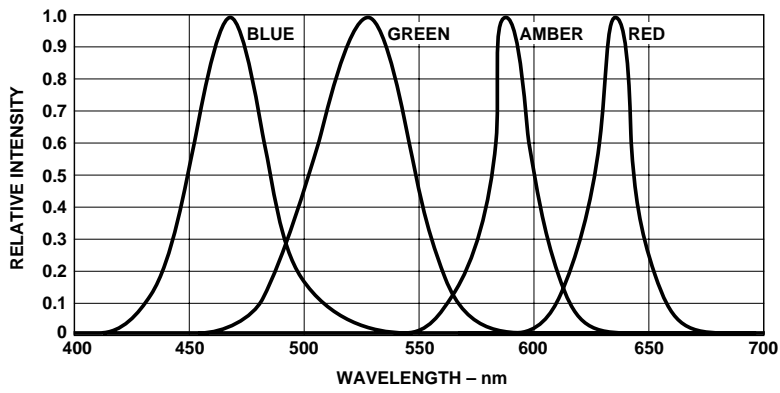

Figure 1. Relative intensity vs. wavelength.

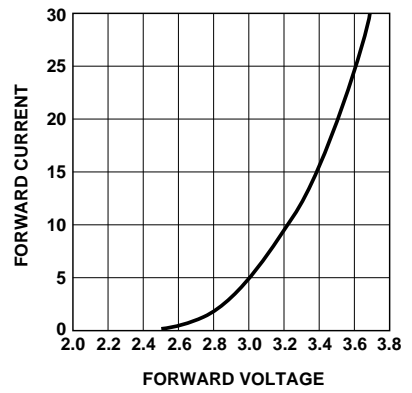

Figure 2. Blue, green forward current vs. forward voltage.

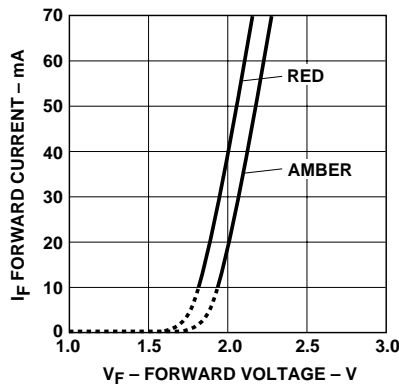

Figure 3a. Amber, red forward current vs. forward voltage.

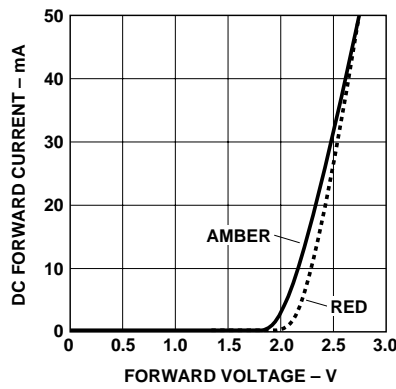

Figure 3b. Forward current vs. forward voltage for option -xxTxX red, and option -xxRxx and -xxSxx amber.

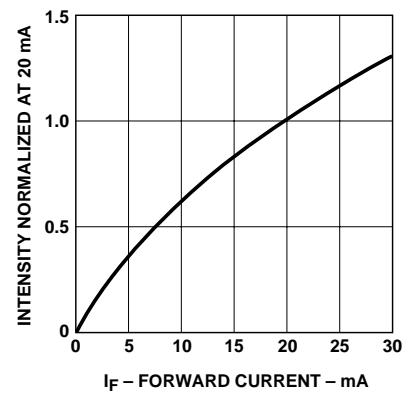

Figure 4. Blue, green relative luminous intensity vs. forward current.

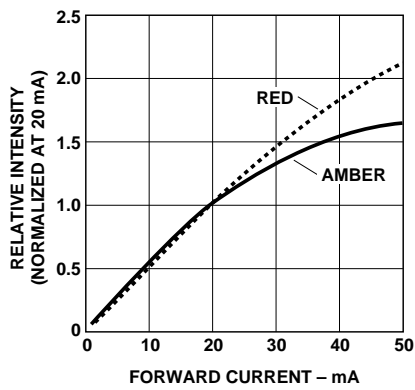

Figure 5. Amber, red relative luminous intensity vs. forward current.

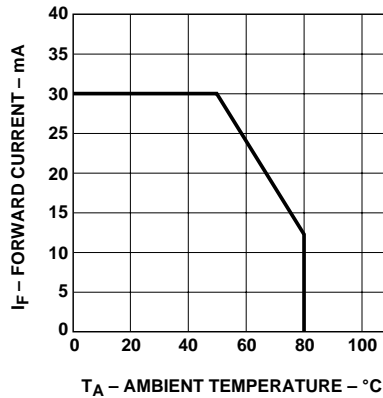

Figure 6. Blue, green maximum forward current vs. ambient temperature.

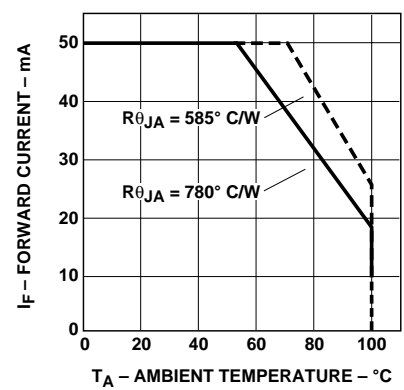

Figure 7. Amber, red maximum forward current vs. ambient temperature.



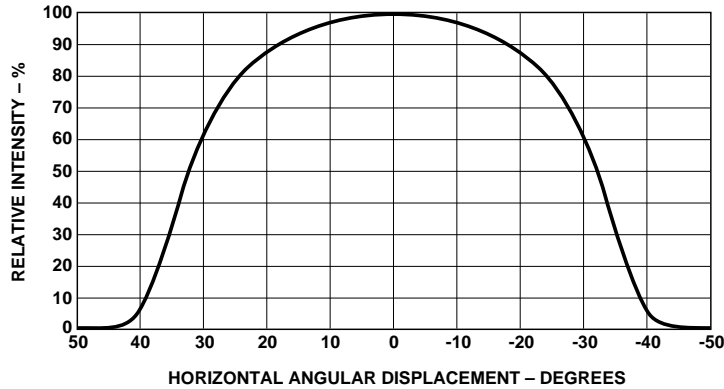
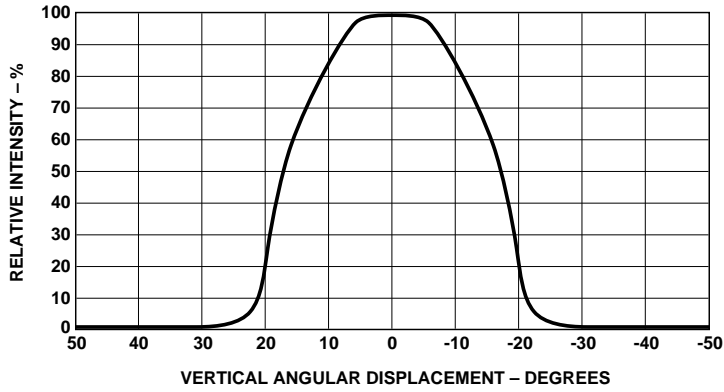

Figure 8. Spatial radiation pattern – 35 x 70 degree lamps.

**Intensity Bin Limits  
(mcd at 20 mA)**

Bin Name	Min.	Max.
G	140	180
H	180	240
J	240	310
K	310	400
L	400	520
M	520	680
N	680	880
P	880	1150
Q	1150	1500
R	1500	1900
S	1900	2500
T	2500	3200
U	1900	2500

Tolerance for each bin limit is  $\pm 15\%$ .

**Amber Color Bin Limits  
(nm at 20 mA)**

Bin Name	Min.	Max.
1	584.5	587.0
2	587.0	589.5
4	589.5	592.0
6	592.0	594.5

Tolerance for each bin limit is  $\pm 0.5$  nm.

**Blue Color Bin Limits  
(nm at 20 mA)**

Bin Name	Min.	Max.
1	460.0	464.0
2	464.0	468.0
3	468.0	472.0
4	472.0	476.0
5	476.0	480.0

Tolerance for each bin limit is  $\pm 0.5$  nm.

**Green Color Bin Limits  
(nm at 20 mA)**

Bin Name	Min.	Max.
1	520.0	524.0
2	524.0	528.0
3	528.0	532.0
4	532.0	536.0
5	536.0	540.0

Tolerance for each bin limit is  $\pm 0.5$  nm.

**Vf Bin Table<sup>[2]</sup>**

Bin Id	Min.	Max.
VA	2.0	2.2
VB	2.2	2.4
VC	2.4	2.6

**Notes:**

1. All bin categories are established for classification of products. Products may not be available in all bin categories. Please contact your Avago representative for further information.
2. Vf bin table only available for those numbers with options -xxRxx, -xxSxx, -xxTxx.

For product information and a complete list of distributors, please go to our website: [www.avagotech.com](http://www.avagotech.com)

Avago, Avago Technologies, and the A logo are trademarks of Avago Technologies Limited in the United States and other countries.  
Data subject to change. Copyright © 2007 Avago Technologies Limited. All rights reserved. Obsoletes 5988-9224EN  
5989-1903EN January 19, 2007

