

WD1943(8136) Dual Baud Rate Clock

WD1943

FEATURES

- 16 SELECTABLE BAUD RATE CLOCK FREQUENCIES
- OPERATES WITH CRYSTAL OSCILLATOR OR EXTERNALLY GENERATED FREQUENCY INPUT
- ROM MASKABLE FOR NON-STANDARD FREQUENCY SELECTIONS
- INTERFACES EASILY WITH MICROCOMPUTERS
- OUTPUTS A 50% DUTY CYCLE CLOCK WITH 0.01% ACCURACY
- 6 DIFFERENT FREQUENCY/DIVISOR PAIRS AVAILABLE
- SINGLE +5V POWER SUPPLY
- COMPATIBLE WITH BR1941
- TTL, MOS COMPATIBILITY
- XTAL FREQ ÷ 4 OUTPUT INCLUDED
- WD1943 IS PIN COMPATIBLE TO THE COM8136 AND COM5036 (PIN 9 ON WD1943 IS A NO CONNECT)
- CAN REPLACE COM8116 AND COM5016 (Contact Western Digital Representative)

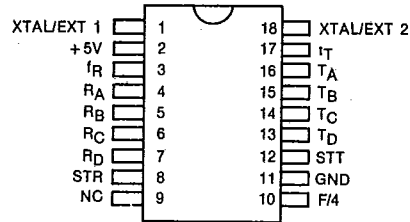

PIN DESIGNATION

DESCRIPTION

The WD1943 is a combination Baud Rate Clock Generator and Programmable Divider. It is manufactured in N-channel MOS using silicon gate technology. This device is capable of generating 16 externally selected clock rates whose frequency is determined by either a single crystal or an externally generated input clock. The WD1943 is a programmable counter capable of generating a division by any integer from 4 to $2^{15} - 1$, inclusive.

The WD1943 is available programmed with the most used frequencies in data communication. Each frequency is selectable by strobing or hard wiring each of the two sets of four Rate Select Inputs. Other frequencies/division rates can be generated by reprogramming the internal ROM coding through a MOS mask change. Additionally, further clock division may be accomplished through cascading of devices. The frequency output is fed into the XTAL/EXT input on a subsequent device.

The WD1943 can be driven by an external crystal or by TTL logic.

WD1943

PIN DESCRIPTION

PIN NUMBER	MNEMONIC	SIGNAL NAME	FUNCTION
1	XTAL/EXT 1	Crystal or External Input 1	This input receives one pin of the crystal package or one polarity of the external input.
2	VCC	Power Supply	+ 5 volt Supply
3	f _R	Receiver Output Frequency	This output runs at a frequency selected by the Receiver Address inputs.
4-7	R _A , R _B , R _C , R _D	Receiver Address	The logic level on these inputs as shown in Table 1 thru 6, selects the receiver output frequency, f _R .
8	STR	Strobe-Receiver Address	A high-level input strobe loads the receiver address (R _A , R _B , R _C , R _D) into the receiver address register. This input may be strobed or hard wired to +5V.
9	NC	No Connection	No Internal Connection
10	f/4	XTAL freq ÷ 4 Output	XTAL1 input freq divided by four.
11	GND	Ground	Ground
12	STT	Strobe-Transmitter Address	A high-level input strobe loads the transmitter address (T _A , T _B , T _C , T _D) into the transmitter address register. This input may be strobed or hard wired to +5V.
13-16	T _D , T _C , T _B , T _A	Transmitter Address	The logic level on these inputs, as shown in Table 1 thru 6, selects the transmitter output frequency, f _T .
17	f _T	Transmitter Output Frequency	This output runs at a frequency selected by the Transmitter Address inputs.
18	XTAL/EXT 2	Crystal or External Input 2	This input receives the other pin of the crystal package or the other polarity of the external input.

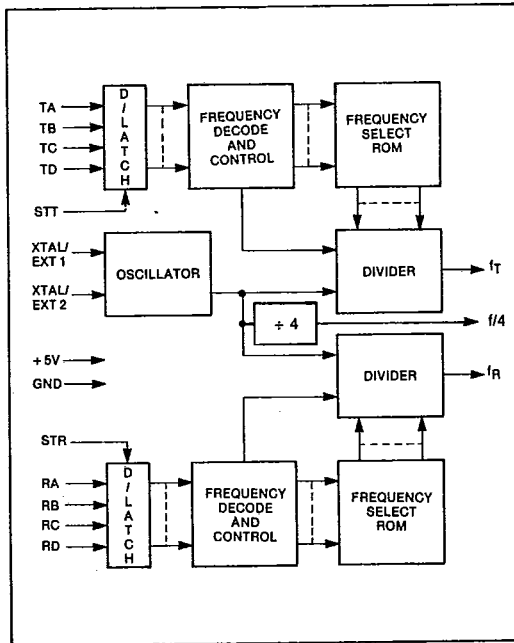

BLOCK DIAGRAM

ELECTRICAL CHARACTERISTICS ($T_A = 0^\circ\text{C}$ to $+70^\circ\text{C}$, $V_{CC} = +5\text{V} \pm 5\%$ standard.)

PARAMETER	MIN	TYP	MAX	UNIT	COMMENTS
DC CHARACTERISTICS					
INPUT VOLTAGE LEVELS					
Low-level, V_{IL}	2.0		0.8	V	See Note 1
High-level, V_{IH}			V_{CC}	V	
OUTPUT VOLTAGE LEVELS					
Low-level, V_{OL}	$V_{CC}-1.5$	4.0	0.4	V	$I_{OL} = 3.2\text{mA}$ $I_{OH} = 100\mu\text{A}$
High-level, V_{OH}			V		
INPUT CURRENT					
High-level, I_{IH}			-10	μA	$V_{IN} = V_{CC}$ } STR (8) and STT (12) Only $V_{IN} = \text{GND}$ }
Low-level, I_{IL}			10	μA	
Low-level, I_{IL}			300	μA	
INPUT CAPACITANCE					
All inputs, C_{IN}		5	10	pf	$V_{IN} = \text{GND}$, excluding XTAL inputs
EXT. INPUT LOAD					
		4	5		Series 7400 unit loads
INPUT RESISTANCE					
Crystal Input, R_{XTAL}	1.1			K Ω	Resistance to ground for Pin 1 and Pin 18
POWER SUPPLY CURRENT					
I_{CC}		40	80	mA	
AC CHARACTERISTICS					
$T_A = +25^\circ\text{C}$					
CLOCK FREQUENCY					
					See Note 2
PULSE WIDTH (T_{PW})					
Clock					
Receiver strobe	150		DC	ns	50% Duty Cycle $\pm 10\%$. See Note 2 See Note 3
Transmitter strobe	150		DC	ns	
INPUT SET-UP TIME (T_{SET-UP})					
Address	50			ns	See Note 3
OUTPUT HOLD TIME (T_{HOLD})					
Address	50			ns	
STROBE TO NEW FREQUENCY DELAY					
			6	CLK	

NOTE 1: XTAL/EXT inputs are either TTL compatible or crystal compatible. See crystal specification in Applications Information section.

All inputs except XTAL, STR and STT have internal pull-up resistors.

NOTE 2: Refer to frequency option tables for maximum input frequency on XTAL/EXT pins.

Typical clock pulse width is $1/2 \times \text{CL}$.

NOTE 3: Input set-up time can be decreased to >0 ns by increasing the minimum strobe width (50 ns) to a total of 200 ns.

T_{A-D} and R_{A-D} have internal pull-up resistors.

OPERATION

Standard Frequencies

Choose a Transmitter and Receiver frequency from the table below. Program the corresponding address into TA-TD and RA-RD respectively using strobe pulses or by hard wiring the strobe and address inputs.

Non-Standard Frequencies

To accomplish non-standard frequencies do one of the following:

1. Choose a crystal that when divided by the WD1943 generates the desired frequency.
2. Cascade devices by using the frequency outputs as an input to the XTAL/EXT inputs of the subsequent WD1943.
3. Consult the factory for possible changes via ROM mask reprogramming.

WD1943

FREQUENCY OPTIONS

TABLE 1. CRYSTAL FREQUENCY = 5.0688 MHZ

Transmit/Receive Address				Baud Rate (16X Clock)	Theoretical Freq. (kHz)	Actual Freq. (kHz)	Percent Error	Duty Cycle %	Divisor
D	C	B	A						
0	0	0	0	50	0.8	0.8	—	50/50	6336
0	0	0	1	75	1.2	1.2	—	50/50	4224
0	0	1	0	110	1.76	1.76	—	50/50	2880
0	0	1	1	134.5	2.152	2.1523	0.016	50/50	2355
0	1	0	0	150	2.4	2.4	—	50/50	2112
0	1	0	1	300	4.8	4.8	—	50/50	1056
0	1	1	0	600	9.6	9.6	—	50/50	528
0	1	1	1	1200	19.2	19.2	—	50/50	264
1	0	0	0	1800	28.8	28.8	—	50/50	176
1	0	0	1	2000	32.0	32.081	0.253	50/50	158
1	0	1	0	2400	38.4	38.4	—	50/50	132
1	0	1	1	3600	57.6	57.6	—	50/50	88
1	1	0	0	4800	76.8	76.8	—	50/50	66
1	1	0	1	7200	115.2	115.2	—	50/50	44
1	1	1	0	9600	153.6	153.6	—	48/52	33
1	1	1	1	19,200	307.2	316.8	3.125	50/50	16

WD1943-00

TABLE 2. CRYSTAL FREQUENCY = 4.9152 MHZ

Transmit/Receive Address				Baud Rate (16X Clock)	Theoretical Freq. (kHz)	Actual Freq. (kHz)	Percent Error	Duty Cycle %	Divisor
D	C	B	A						
0	0	0	0	50	0.8	0.8	—	50/50	6144
0	0	0	1	75	1.2	1.2	—	50/50	4096
0	0	1	0	110	1.76	1.7598	-0.01	*	2793
0	0	1	1	134.5	2.152	2.152	—	50/50	2284
0	1	0	0	150	2.4	2.4	—	50/50	2048
0	1	0	1	300	4.8	4.8	—	50/50	1024
0	1	1	0	600	9.6	9.6	—	50/50	512
0	1	1	1	1200	19.2	19.2	—	50/50	256
1	0	0	0	1800	28.8	28.7438	-0.19	*	171
1	0	0	1	2000	32.0	31.9168	-0.26	*	154
1	0	1	0	2400	38.4	38.4	—	50/50	128
1	0	1	1	3600	57.6	57.8258	0.39	*	85
1	1	0	0	4800	76.8	76.8	—	50/50	64
1	1	0	1	7200	115.2	114.306	-0.77	*	43
1	1	1	0	9600	153.6	153.6	—	50/50	32
1	1	1	1	19,200	307.2	307.2	—	50/50	16

WD1943-05

TABLE 3. CRYSTAL FREQUENCY = 5.0688 MHZ

Transmit/Receive Address				Baud Rate (32X Clock)	Theoretical Freq. (kHz)	Actual Freq. (kHz)	Percent Error	Duty Cycle %	Divisor
D	C	B	A						
0	0	0	0	50	1.6	1.6	—	50/50	3168
0	0	0	1	75	2.4	2.4	—	50/50	2112
0	0	1	0	110	3.52	3.52	—	50/50	1440
0	0	1	1	134.5	4.304	4.303	.026	50/50	1178
0	1	0	0	150	4.8	4.8	—	50/50	1056
0	1	0	1	200	6.4	6.4	—	50/50	792
0	1	1	0	300	9.6	9.6	—	50/50	528
0	1	1	1	600	19.2	19.2	—	50/50	264
1	0	0	0	1200	38.4	38.4	—	50/50	132
1	0	0	1	1800	57.6	57.6	—	50/50	88
1	0	1	0	2400	76.8	76.8	—	50/50	66
1	0	1	1	3600	115.2	115.2	—	50/50	44
1	1	0	0	4800	153.6	153.6	—	*	33
1	1	0	1	7200	230.4	230.4	—	50/50	22
1	1	1	0	9600	307.2	298.16	2.941	*	17
1	1	1	1	19,200	614.4	633.6	3.125	50/50	8

*When the duty cycle is not exactly 50% it is 50% ± 10%

WD1943-06

APPLICATIONS INFORMATION

WD1943

OPERATION WITH A CRYSTAL

The WD1943 Baud Rate Generator may be driven by either a crystal or TTL level clock. When using a crystal, the waveform that appears at pins 1 (STAL/EXT 1) and 18 (XTAL/EXT 2) does not conform to the normal TTL limits of $V_{IL} \leq 0.8V$ and $V_{IH} \geq 2.0V$. Figure 1 illustrates a typical crystal waveform when connected to a WD1943.

Since the D.C. level of the waveform causes the least positive point to typically be greater than 0.8V, the WD1943 is designed to look for an edge, as opposed to a TTL level. The XTAL/EXT logic triggers on a rising edge of typically 1V in magnitude. This allows the use of a crystal without any additional components.

OPERATIONS WITH TTL LEVEL CLOCK

With clock frequencies in the area of 5 MHz, significant overshoot and undershoot ("ringing") can appear at pins 1 and/or 18. The clock oscillator may, at times be triggered on a rising edge of an overshoot or undershoot waveform, causing the device to effectively "double-trigger." This phenomenon may result as a twice expected baud rate, or as an apparent device failure. Figure 2 shows a typical waveform that exhibits the "ringing" problem.

The design methods required to minimize ringing include the following:

1. Minimize the P.C. trace length. At 5 MHz, each inch of trace can add significantly to overshoot and undershoot.
2. Match impedances at both ends of the trace. For example, a series resistor near the device may be helpful.
3. A uniform impedance is important. This can be accomplished through the use of:
 - a. parallel ground lines
 - b. evenly spaced ground lines crossing the trace on the opposite side of PC board
 - c. an inner plane of ground, e.g., as in a four layered PC board.

In the event that ringing exists on an already finished board, several techniques can be used to reduce it. These are:

1. Add a series resistor to match impedance as shown in Figure 3.
2. Add pull-up/pull-down resistor to match impedance, as shown in Figure 4.
3. Add a high speed diode to clamp undershoot, as shown in Figure 5.

The method that is easiest to implement in many systems is method 1, the series resistor. The series resistor will cause the D.C. level to shift up, but that does not cause a problem since the OSC is triggered by an edge, as opposed to a TTL level.

The 1943 Baud Rate Generator can save both board space and cost in a communications system. By choosing either a crystal or a TTL level clock, the user can minimize the logic required to provide baud rate clocks in a given design.

POWER LINE SPIKES

Voltage transients on the AC power line may appear on the DC power output. If this possibility exists, it is suggested that a by-pass capacitor is used between +5V and GND.

CRYSTAL SPECIFICATIONS

User must specify termination (pin, wire, other)
Frequency — See Tables 1-6.
Type: Microprocessor Crystal
Temperature range 0°C to +70°C
Series resistance 50Ω to 100Ω
Series resonant to 100Ω
Overall tolerance ± 0.01%

CRYSTAL MANUFACTURERS (Partial List)

American Time Products Div.
Frequency Control Products, Inc.
Woodside, New York 11377

Bliley Electric Co.
Erie, Pennsylvania 16508

M-tron Ind. Inc.
Yankton, South Dakota 57078

Erie Frequency Control
Calisle, Pennsylvania 17013

Q-Matic Corporation
Costa Mesa, California 92626

WD1943

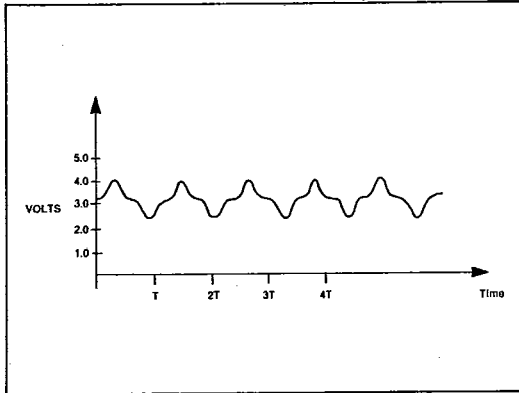

FIGURE 1. TYPICAL CRYSTAL WAVEFORM

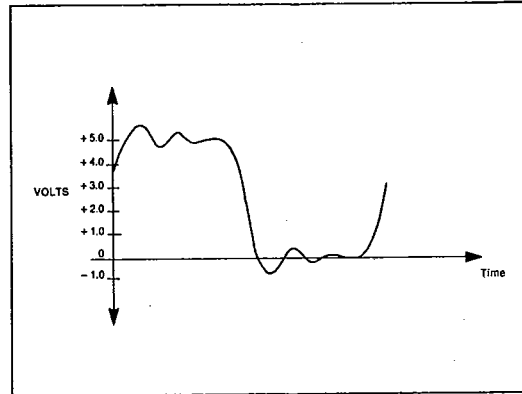

FIGURE 2. TYPICAL "RINGING" WAVEFORM from TTL INPUT

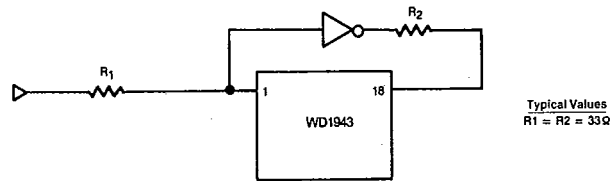

FIGURE 3. SERIES RESISTOR TO MATCH IMPEDANCE

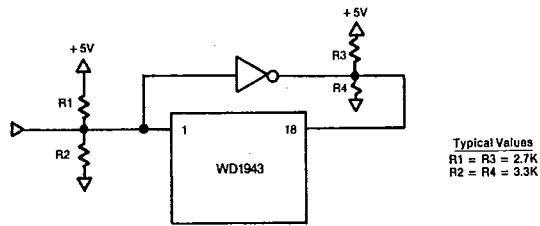

FIGURE 4. PULL-UP/PULL-DOWN RESISTORS TO MATCH IMPEDANCE

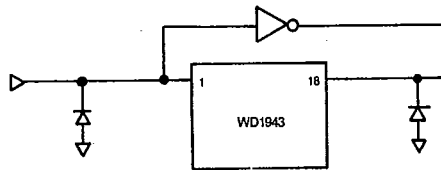
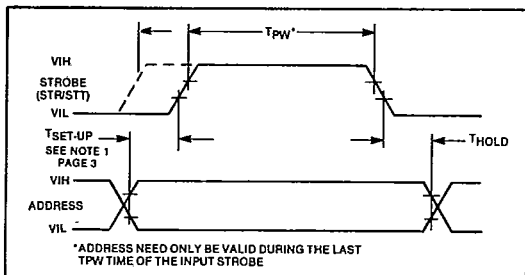
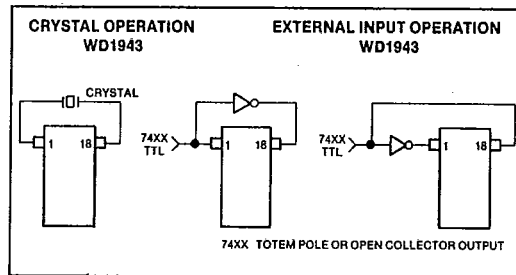

FIGURE 5. HIGH-SPEED DIODE TO CLAMP UNDERSHOOT



CONTROL TIMING



CRYSTAL/CLOCK OPTIONS

ABSOLUTE MAXIMUM RATINGS

Positive Voltage on any Pin, with respect to ground	+ 7.0V
Negative Voltage on any Pin, with respect to ground	- 0.3V
Storage Temperature	(plastic package) - 55°C to + 125°C (Cerdip package and Ceramic package) - 65°C to + 150°C
Lead Temperature (Soldering, 10 sec.)	+ 325°C

*Stresses above those listed may cause permanent damage to the device. This is a stress rating only and Functional Operation of the device at these or at any other condition above those indicated in the operational sections of this specification are not implied.