

IRFB17N60K

SMPS MOSFET

HEXFET® Power MOSFET

Applications

- Switch Mode Power Supply (SMPS)
- Uninterruptible Power Supply
- High Speed Power Switching
- Hard Switched and High Frequency Circuits

V _{DSS}	R _{DS(on)} typ.	I _D
600V	0.35Ω	17A

Benefits

- Smaller TO-220 Package
- Low Gate Charge Q_g results in Simple Drive Requirement
- Improved Gate, Avalanche and Dynamic dv/dt Ruggedness
- Fully Characterized Capacitance and Avalanche Voltage and Current

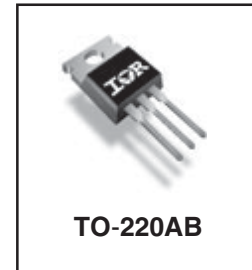

Absolute Maximum Ratings

	Parameter	Max.	Units
I _D @ T _C = 25°C	Continuous Drain Current, V _{GS} @ 10V	17	A
I _D @ T _C = 100°C	Continuous Drain Current, V _{GS} @ 10V	11	
I _{DM}	Pulsed Drain Current ①	68	
P _D @ T _C = 25°C	Power Dissipation	340	W
	Linear Derating Factor	2.7	W/°C
V _{GS}	Gate-to-Source Voltage	± 30	V
dv/dt	Peak Diode Recovery dv/dt ③	11	V/ns
T _J	Operating Junction and	-55 to + 150	°C
T _{STG}	Storage Temperature Range		
	Soldering Temperature, for 10 seconds (1.6mm from case)	300	
	Mounting Torque, 6-32 or M3 screw	10	N

Avalanche Characteristics

Symbol	Parameter	Typ.	Max.	Units
E _{AS}	Single Pulse Avalanche Energy②	—	330	mJ
I _{AR}	Avalanche Current①	—	17	A
E _{AR}	Repetitive Avalanche Energy①	—	34	mJ

Thermal Resistance

Symbol	Parameter	Typ.	Max.	Units
R _{θJC}	Junction-to-Case	—	0.37	°C/W
R _{θCS}	Case-to-Sink, Flat, Greased Surface	0.50	—	
R _{θJA}	Junction-to-Ambient	—	58	

IRFB17N60K

International
IR Rectifier

www.datasheet4u.com

Static @ $T_J = 25^\circ\text{C}$ (unless otherwise specified)

Symbol	Parameter	Min.	Typ.	Max.	Units	Conditions
$V_{(BR)DSS}$	Drain-to-Source Breakdown Voltage	600	—	—	V	$V_{GS} = 0V, I_D = 250\mu A$
$\Delta V_{(BR)DSS}/\Delta T_J$	Breakdown Voltage Temp. Coefficient	—	0.60	—	V/°C	Reference to $25^\circ\text{C}, I_D = 1\text{mA}$
$R_{DS(on)}$	Static Drain-to-Source On-Resistance	—	0.35	0.42	Ω	$V_{GS} = 10V, I_D = 10A$ ④
$V_{GS(th)}$	Gate Threshold Voltage	3.0	—	5.0	V	$V_{DS} = V_{GS}, I_D = 250\mu A$
I_{DSS}	Drain-to-Source Leakage Current	—	—	50	μA	$V_{DS} = 600V, V_{GS} = 0V$
		—	—	250	μA	$V_{DS} = 480V, V_{GS} = 0V, T_J = 125^\circ\text{C}$
I_{GSS}	Gate-to-Source Forward Leakage	—	—	100	nA	$V_{GS} = 30V$
	Gate-to-Source Reverse Leakage	—	—	-100		$V_{GS} = -30V$

Dynamic @ $T_J = 25^\circ\text{C}$ (unless otherwise specified)

Symbol	Parameter	Min.	Typ.	Max.	Units	Conditions
g_{fs}	Forward Transconductance	5.9	—	—	S	$V_{DS} = 50V, I_D = 10A$
Q_g	Total Gate Charge	—	—	99	nC	$I_D = 17A$
Q_{gs}	Gate-to-Source Charge	—	—	32		$V_{DS} = 480V$
Q_{gd}	Gate-to-Drain ("Miller") Charge	—	—	47		$V_{GS} = 10V, \text{See Fig. 6 and 13 } \textcircled{4}$
$t_{d(on)}$	Turn-On Delay Time	—	25	—	ns	$V_{DD} = 300V$
t_r	Rise Time	—	82	—		$I_D = 17A$
$t_{d(off)}$	Turn-Off Delay Time	—	38	—		$R_G = 7.5\Omega$
t_f	Fall Time	—	32	—		$V_{GS} = 10V, \text{See Fig. 10 } \textcircled{4}$
C_{iss}	Input Capacitance	—	2700	—	pF	$V_{GS} = 0V$
C_{oss}	Output Capacitance	—	240	—		$V_{DS} = 25V$
C_{rss}	Reverse Transfer Capacitance	—	21	—		$f = 1.0\text{MHz}, \text{See Fig. 5}$
C_{oss}	Output Capacitance	—	2950	—		$V_{GS} = 0V, V_{DS} = 1.0V, f = 1.0\text{MHz}$
C_{oss}	Output Capacitance	—	67	—		$V_{GS} = 0V, V_{DS} = 480V, f = 1.0\text{MHz}$
$C_{oss \text{ eff.}}$	Effective Output Capacitance	—	120	—		$V_{GS} = 0V, V_{DS} = 0V \text{ to } 480V \textcircled{5}$

Diode Characteristics

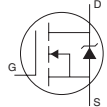
Symbol	Parameter	Min.	Typ.	Max.	Units	Conditions
I_S	Continuous Source Current (Body Diode)	—	—	17	A	MOSFET symbol showing the integral reverse p-n junction diode. 
I_{SM}	Pulsed Source Current (Body Diode) ①	—	—	68		
V_{SD}	Diode Forward Voltage	—	—	1.5	V	$T_J = 25^\circ\text{C}, I_S = 17A, V_{GS} = 0V$ ④
t_{rr}	Reverse Recovery Time	—	520	780	ns	$T_J = 25^\circ\text{C}, I_F = 17A$
Q_{rr}	Reverse Recovery Charge	—	5620	8430	nC	$di/dt = 100A/\mu s$ ④
t_{rr}	Reverse Recovery Time	—	580	870	ns	$T_J = 125^\circ\text{C}, I_F = 17A$
Q_{rr}	Reverse Recovery Charge	—	6470	9700	nC	$di/dt = 100A/\mu s$ ④
t_{on}	Forward Turn-On Time	Intrinsic turn-on time is negligible (turn-on is dominated by $L_S + L_D$)				

Notes:

- ① Repetitive rating; pulse width limited by max. junction temperature.
 ② Starting $T_J = 25^\circ\text{C}, L = 2.3\text{mH}, R_G = 25\Omega, I_{AS} = 17A,$

- ③ $I_{SD} \leq 17A, di/dt \leq 380A/\mu s, V_{DD} \leq V_{(BR)DSS}, T_J \leq 150^\circ\text{C}$

- ④ Pulse width $\leq 300\mu s$; duty cycle $\leq 2\%$.

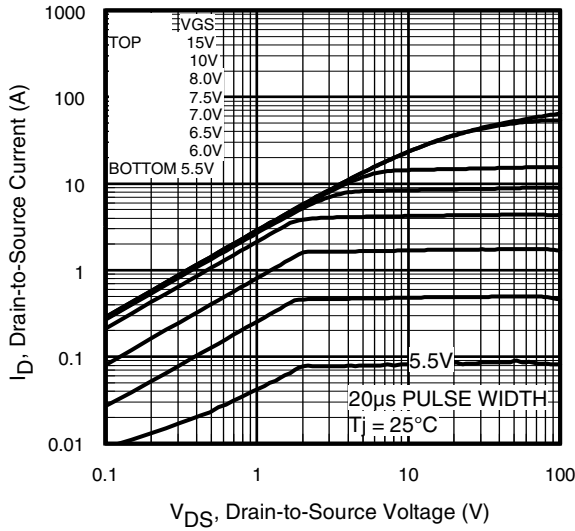

Fig 1. Typical Output Characteristics

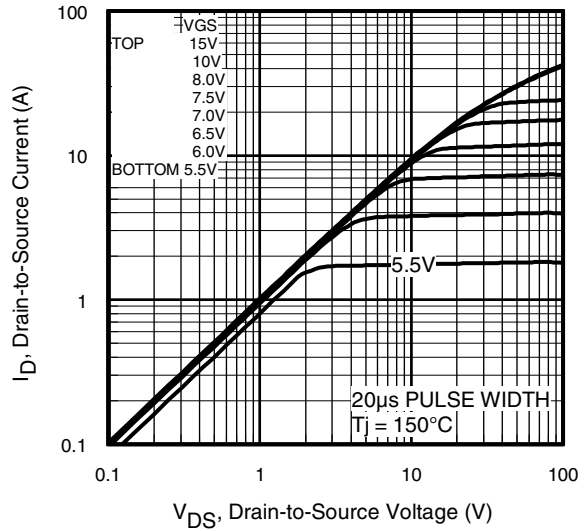

Fig 2. Typical Output Characteristics

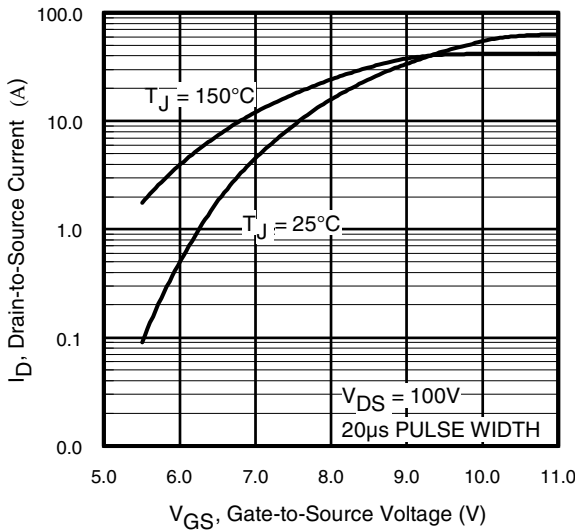

Fig 3. Typical Transfer Characteristics

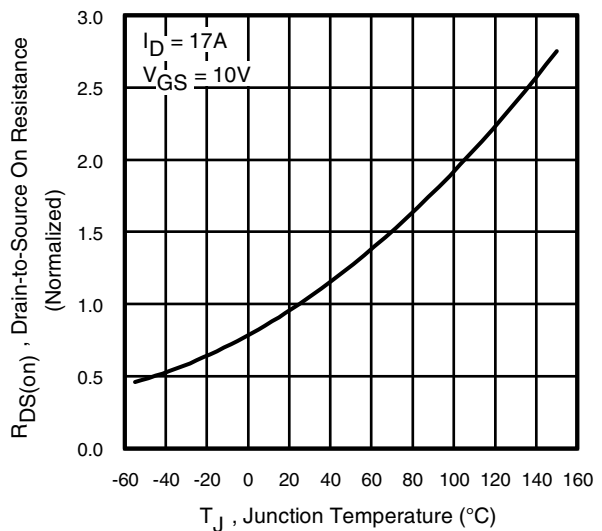

Fig 4. Normalized On-Resistance Vs. Temperature

IRFB17N60K

International
IR Rectifier

www.datasheet4u.com

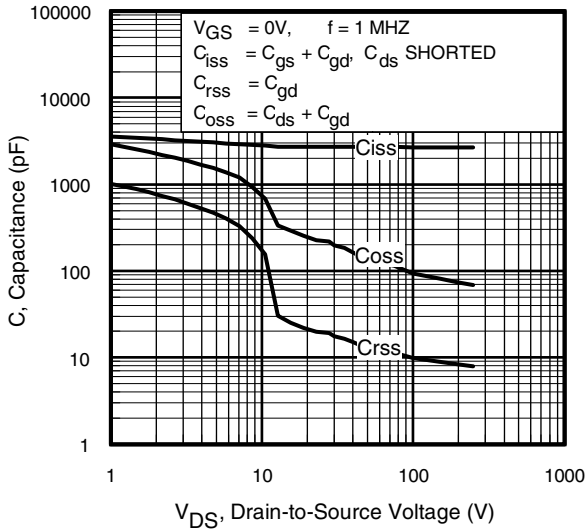

Fig 5. Typical Capacitance Vs. Drain-to-Source Voltage

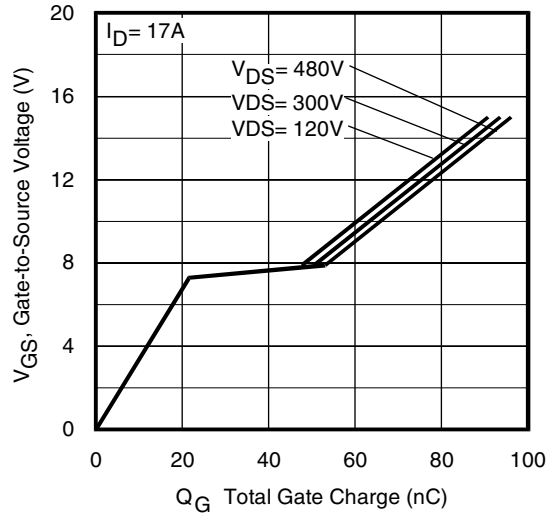

Fig 6. Typical Gate Charge Vs. Gate-to-Source Voltage

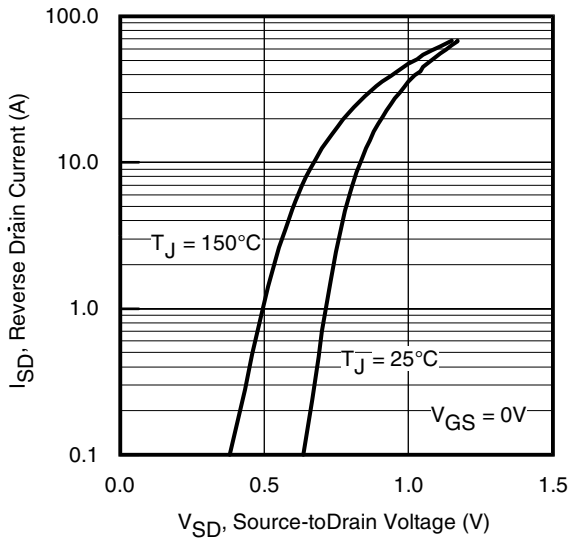

Fig 7. Typical Source-Drain Diode Forward Voltage

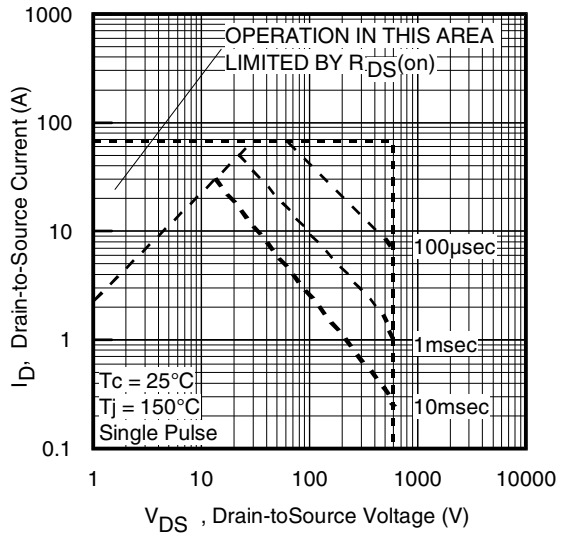

Fig 8. Maximum Safe Operating Area

IRFB17N60K

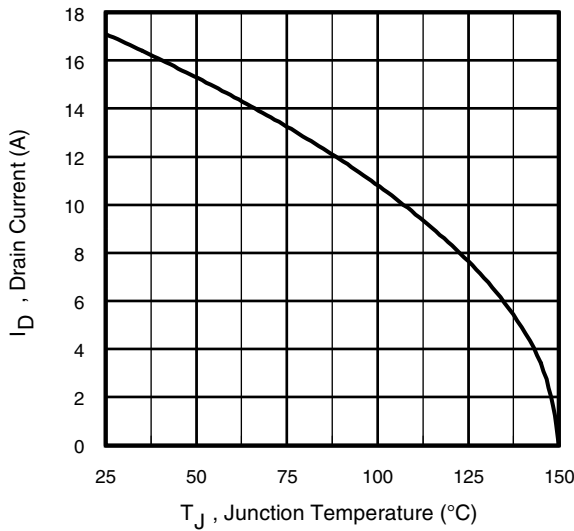

Fig 9. Maximum Drain Current Vs. Case Temperature

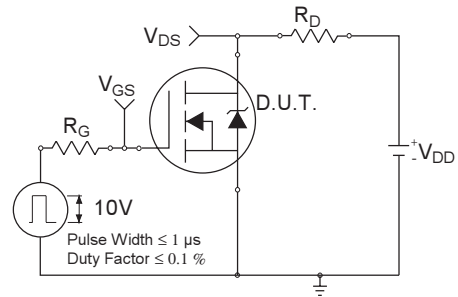

Fig 10a. Switching Time Test Circuit

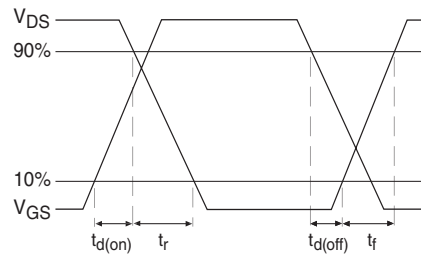

Fig 10b. Switching Time Waveforms

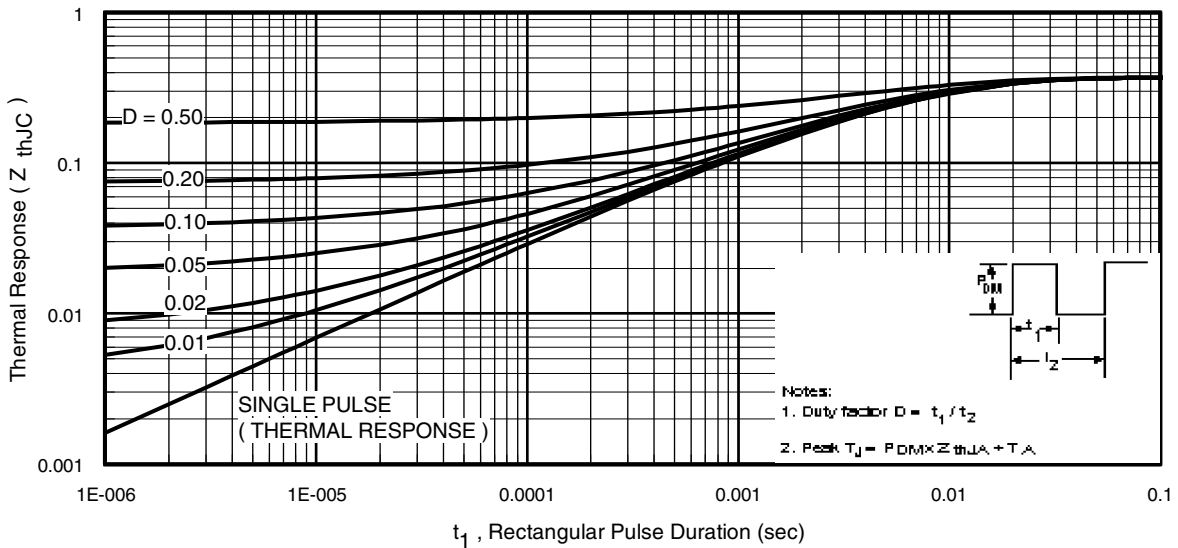

Fig 11. Maximum Effective Transient Thermal Impedance, Junction-to-Case

IRFB17N60K

International
IR Rectifier

www.datasheet4u.com

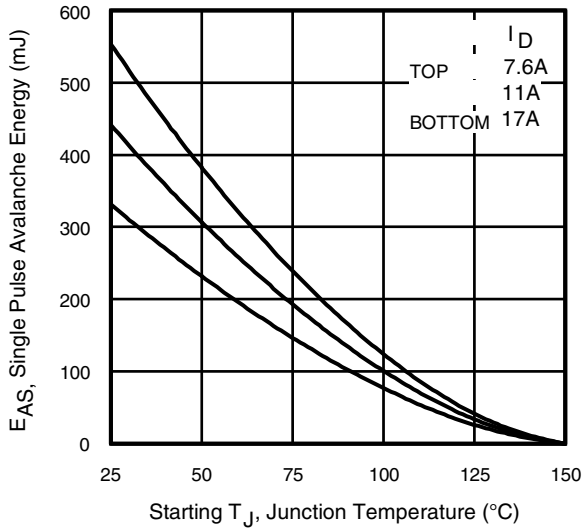

Fig 12a. Maximum Avalanche Energy Vs. Drain Current

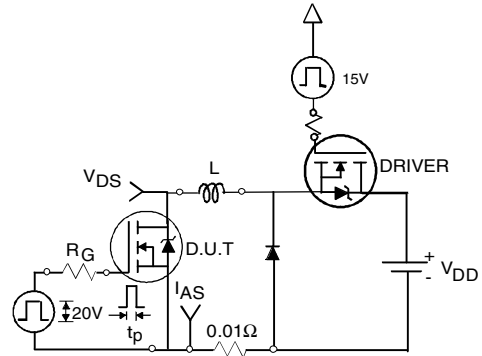

Fig 12c. Unclamped Inductive Test Circuit

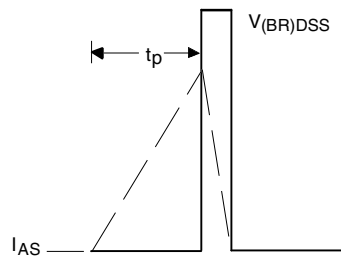

Fig 12d. Unclamped Inductive Waveforms

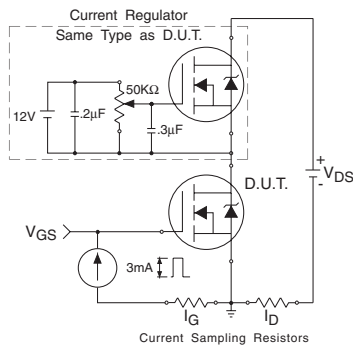

Fig 13a. Gate Charge Test Circuit

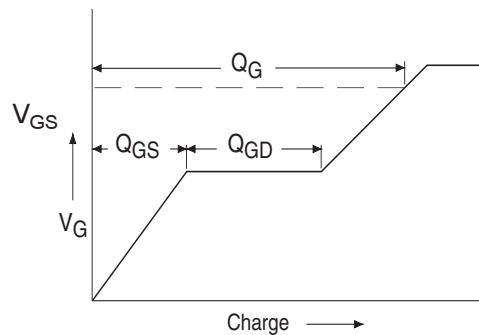
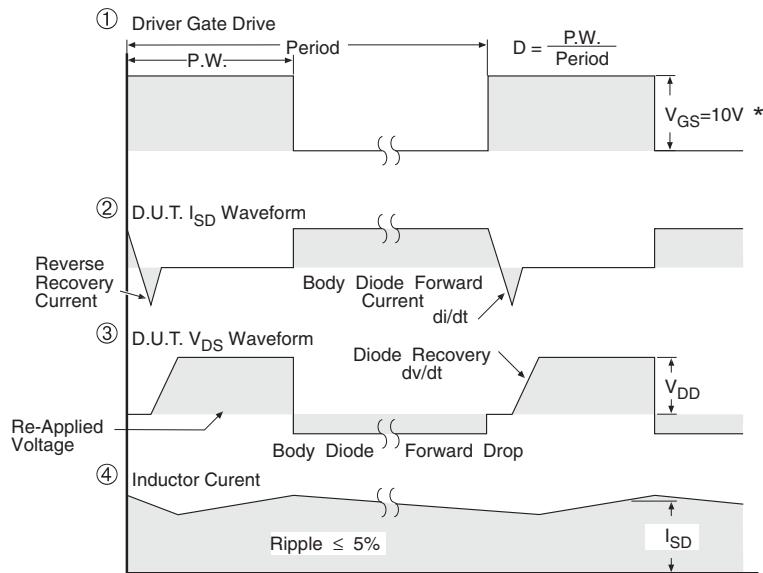
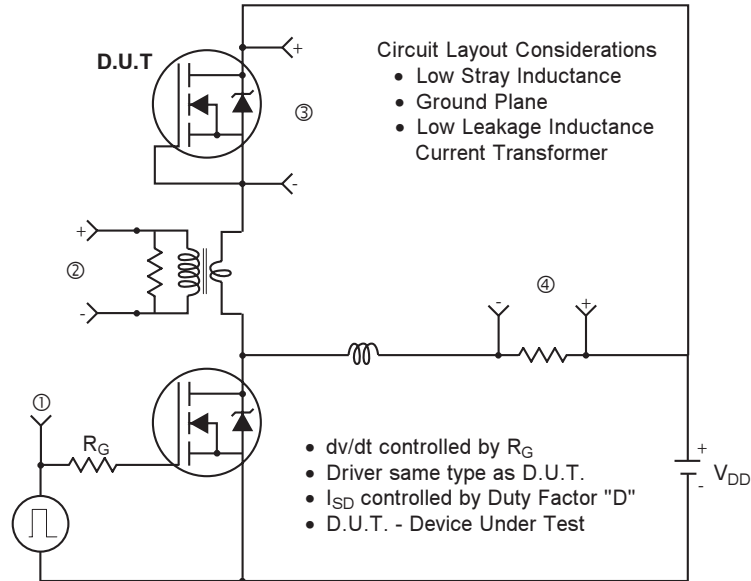

Fig 13b. Basic Gate Charge Waveform

Peak Diode Recovery dv/dt Test Circuit



* $V_{GS} = 5V$ for Logic Level Devices

Fig 14. For N-Channel HEXFET® Power MOSFETs

IRFB17N60K

International
IR Rectifier

TO-220AB Package Outline

Dimensions are shown in millimeters (inches)

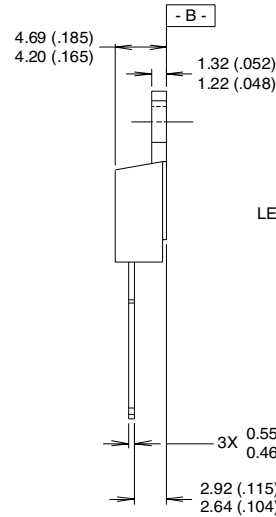
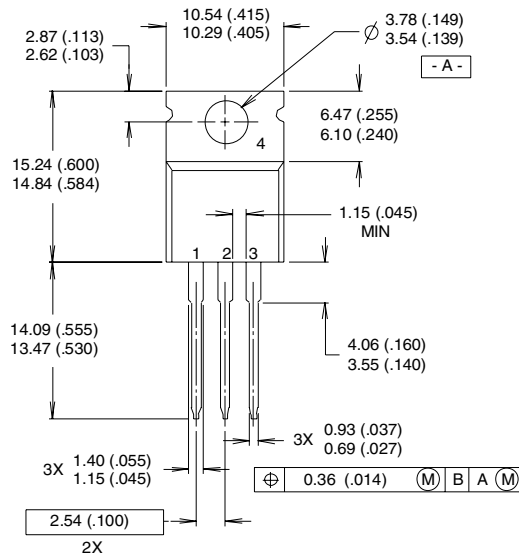

LEAD ASSIGNMENTS
 1 - GATE
 2 - DRAIN
 3 - SOURCE
 4 - DRAIN

NOTES:

- 1 DIMENSIONING & TOLERANCING PER ANSI Y14.5M, 1982.
- 2 CONTROLLING DIMENSION : INCH
- 3 OUTLINE CONFORMS TO JEDEC OUTLINE TO-220AB.
- 4 HEATSINK & LEAD MEASUREMENTS DO NOT INCLUDE BURRS.

TO-220AB Part Marking Information

EXAMPLE : THIS IS AN IRF1010
 WITH ASSEMBLY
 LOT CODE 9B1M

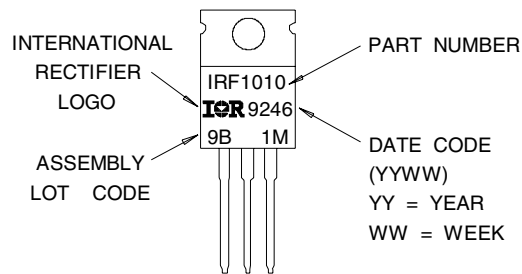

TO-220AB package is not recommended for Surface Mount Application

Data and specifications subject to change without notice.
 This product has been designed and qualified for the Automotive [Q101] market.
 Qualification Standards can be found on IR's Web site.

International
IR Rectifier

IR WORLD HEADQUARTERS: 233 Kansas St., El Segundo, California 90245, USA Tel: (310) 252-7105
 TAC Fax: (310) 252-7903

Visit us at www.irf.com for sales contact information.11/02

www.irf.com