

### 3-TERMINAL 1A POSITIVE ADJUSTABLE REGULATOR

The KIA317P/PI is adjustable 3-terminal positive voltage regulator capable of supplying in excess of 1.5A over a 1.2V to 37V output range.

This is exceptionally easy to use and require only two external resistors to set the output voltage.

Further, both line and load regulation are better than standard fixed regulators.

#### FEATURES

- Adjustable output between 1.2V and 37V
- Guaranteed 1.5A output current
- Line regulation typically 0.001%/V
- Load regulation typically 0.1%
- 80dB ripple rejection (with  $C_{adj}$ )
- Internal thermal overload protection
- Internal short-circuit current limiting
- Output transistor safe-area compensation

#### BLOCK DIAGRAM

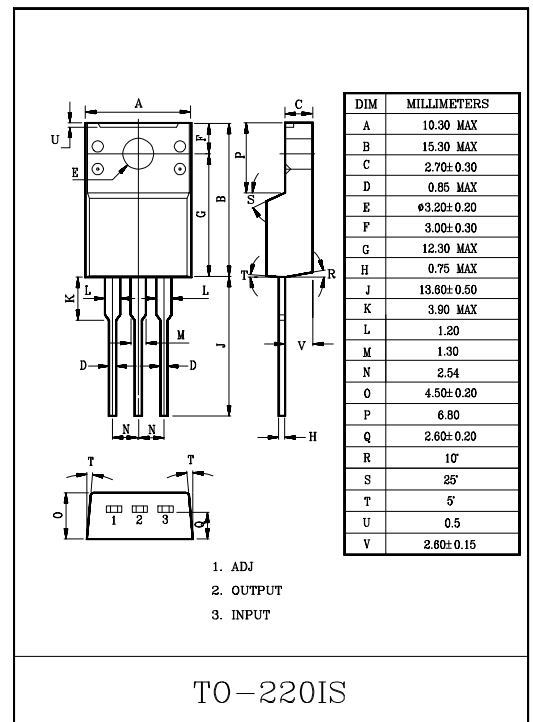
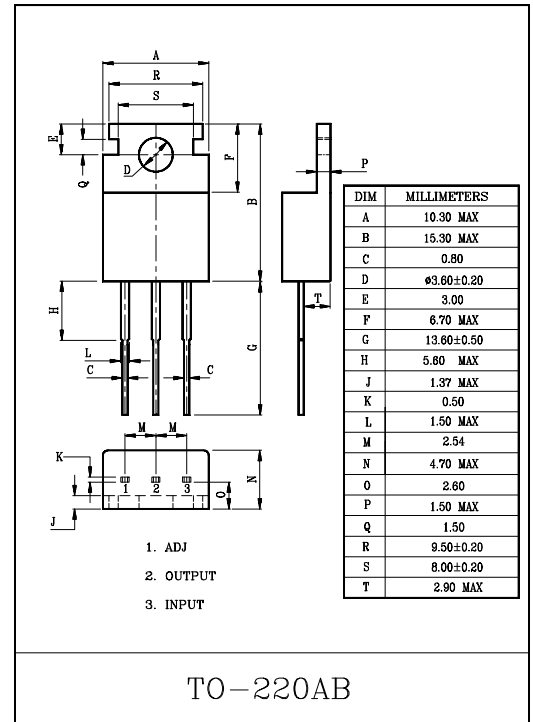
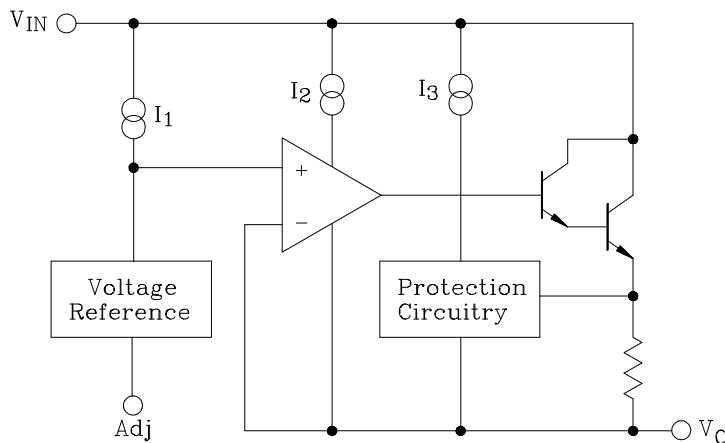

# KIA317P/PI

## MAXIMUM RATINGS (Ta=25°C)

CHARACTERISTIC	SYMBOL	RATING	UNIT
Input-Output Voltage Differential	V <sub>in</sub> -V <sub>out</sub>	40	V
Power Dissipation	P <sub>D</sub>	Internally limited	
Operating Temperature	T <sub>opr</sub>	-30~85	°C
Storage Temperature	T <sub>stg</sub>	-65~150	°C
Lead Temperature	T <sub>lead</sub>	230	°C

## ELECTRICAL CHARACTERISTICS

(V<sub>I</sub>-V<sub>O</sub>=5V, I<sub>O</sub>=0.5A, 0°C ≤ T<sub>j</sub> ≤ 125°C, I<sub>MAX</sub>=1.5A, P<sub>MAX</sub>=20W, unless otherwise specified)

CHARACTERISTIC	SYMBOL	TEST CONDITION	MIN.	TYP.	MAX.	UNIT	
Line Regulation	ΔV <sub>O</sub> (Line)	Ta=25°C, I <sub>O</sub> =10mA	3V ≤ V <sub>in</sub> -V <sub>out</sub> ≤ 40V	-	0.01	0.04	% / V
		Ta=0~125°C, I <sub>O</sub> =10mA		-	0.02	0.07	
Load Regulation	ΔV <sub>O</sub> (Load)	Ta=25°C,	10mA ≤ I <sub>out</sub> ≤ I <sub>MAX</sub>	-	0.1	0.5	%
		Ta=0~125°C,		-	0.3	1.5	
Adjustable Pin Current	I <sub>Adj</sub>		-	50	100	μA	
Adjustable Pin Current Change	ΔI <sub>Adj</sub>	10mA ≤ I <sub>O</sub> ≤ I <sub>MAX</sub> 3V ≤ V <sub>in</sub> -V <sub>out</sub> ≤ 40V	-	0.2	5	μA	
Reference Voltage	V <sub>ref</sub>	10mA ≤ I <sub>O</sub> ≤ I <sub>MAX</sub> 3V ≤ V <sub>in</sub> -V <sub>out</sub> ≤ 40V, P ≤ P <sub>MAX</sub>	1.20	1.25	1.30	V	
Temperature Stability	ST <sub>T</sub>	T <sub>Min</sub> ≤ T <sub>j</sub> ≤ T <sub>MAX</sub>	-	1	-	%	
Minimum Load Current to Maintain Regulation	I <sub>O(MIN)</sub>	(V <sub>in</sub> -V <sub>out</sub> )=40V	-	3.5	10	mA	
Current Limit	I <sub>O(MAX)</sub>	(V <sub>in</sub> -V <sub>out</sub> ) ≤ 15V, P ≤ P <sub>MAX</sub>	1.5	2.2	3.4	A	
		(V <sub>in</sub> -V <sub>out</sub> ) ≤ 40V, P ≤ P <sub>MAX</sub> , Ta=25°C	0.15	0.4	-	A	
Output Noise Voltage	V <sub>NO</sub>	Ta=25°C, 10Hz ≤ f ≤ 10kHz, % of V <sub>out</sub>	-	0.0003	-	%	
Ripple Rejection Ratio	RR	V <sub>O</sub> =10V, f=120Hz	-	65	-	dB	
		C <sub>Adj</sub> =10μF	66	80	-		
Long Term Stability	ST	Ta=25°C for end point measurement, 1000 Hr	-	0.3	1	%	
Thermal Resistance Junction to Case	R <sub>θjc</sub>	-	-	4	-	°C/W	
Thermal Resistance Junction to Ambient (No Heat Sink)	R <sub>θj-a</sub>	-	-	50	-	°C/W	

Note : Load and line regulation are specified at constant junction temperature.

Change in V<sub>O</sub> due to heating effects must be taken into account separately.

Pulse testing with low duty is used.(P<sub>MAX</sub>=20W)

# KIA317P/PI

## TYPICAL APPLICATION (PROGRAMMABLE REGULATOR)

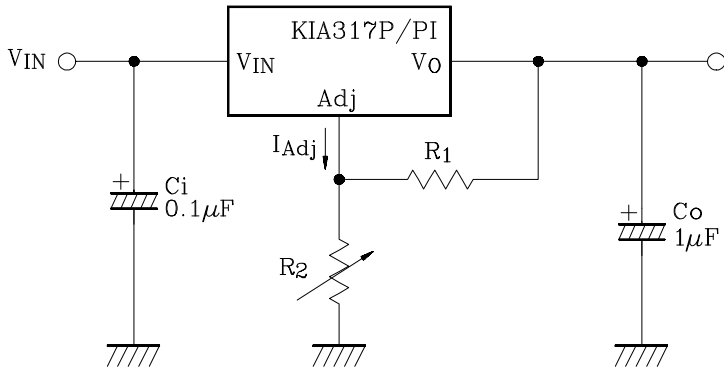

$$V_{out} = 1.25V \left(1 + \frac{R_2}{R_1}\right) + I_{Adj} R_2$$

$C_i$  is required when regulator is located an appreciable distance from power supply filter.

$C_o$  is not needed for stability, however, in the range of  $1\mu\text{F}$  to  $100\mu\text{F}$  of aluminum or tantalum electrolytic are commonly used to provide improved output impedance and rejection of transients.

Since  $I_{Adj}$  is controlled to less than  $100\mu\text{A}$ , the error associated with this term is negligible in most applications.

# KIA317P/PI

### Load Regulation

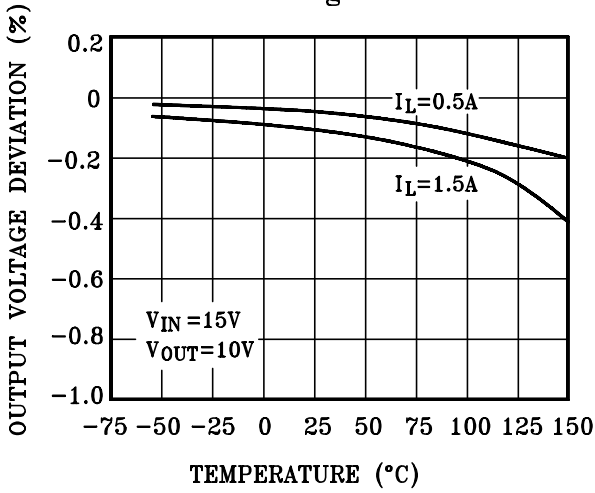

### Current Limit

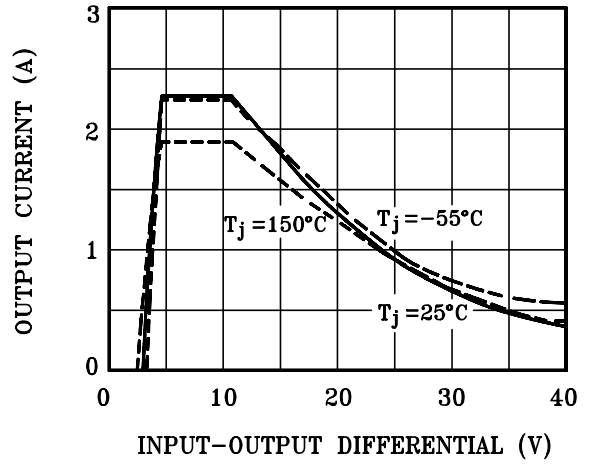

### Adjustment Current

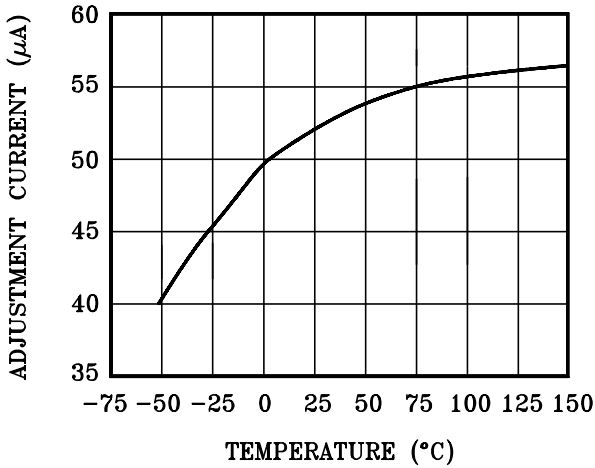

### Dropout Voltage

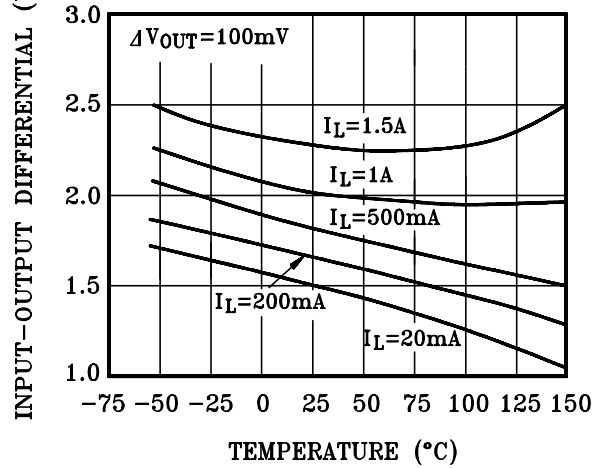

### Temperature Stability

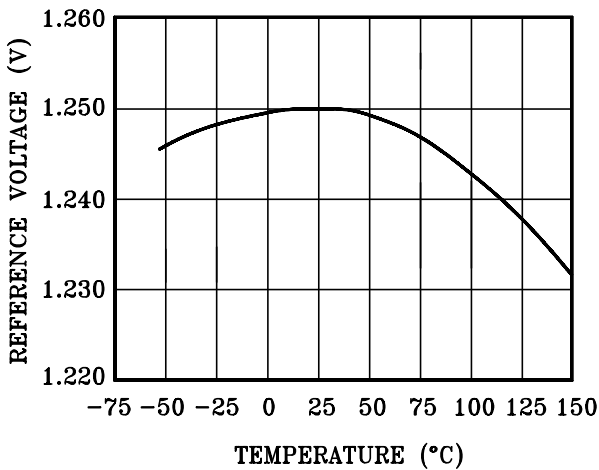

### Minimum Operating Current

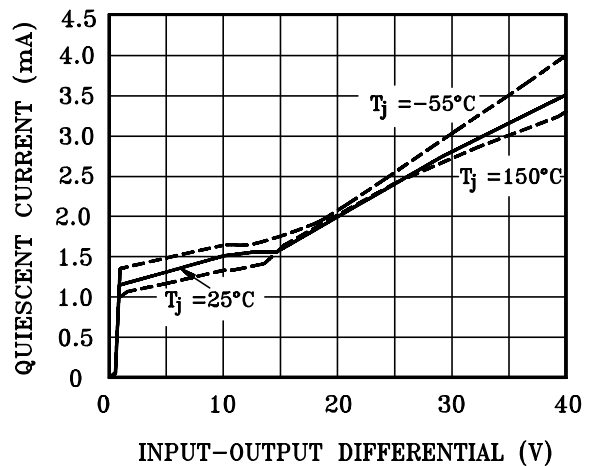

# KIA317P/PI

### Ripple Rejection

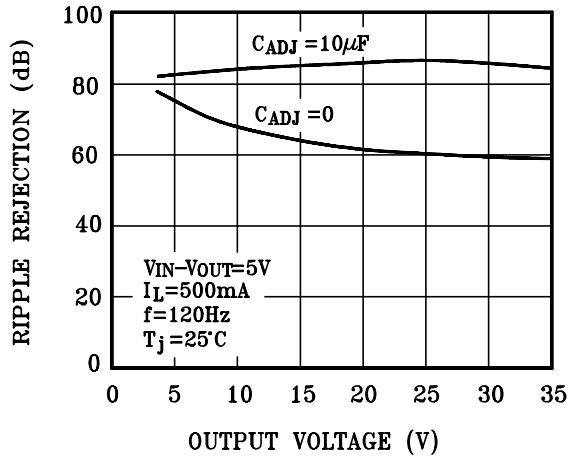

### Ripple Rejection

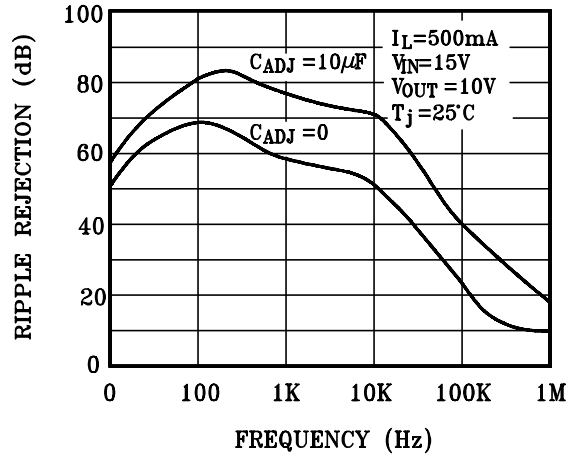

### Ripple Rejection

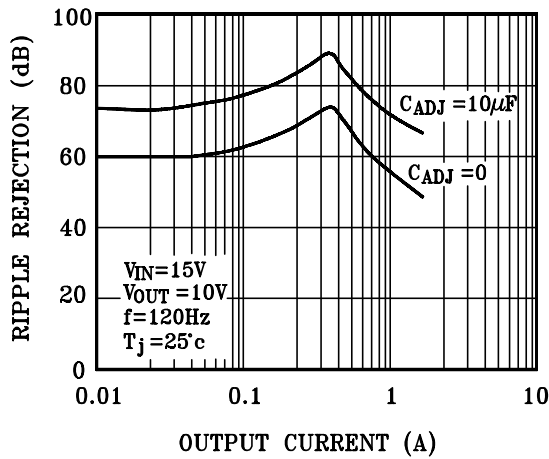

### Output Impedance

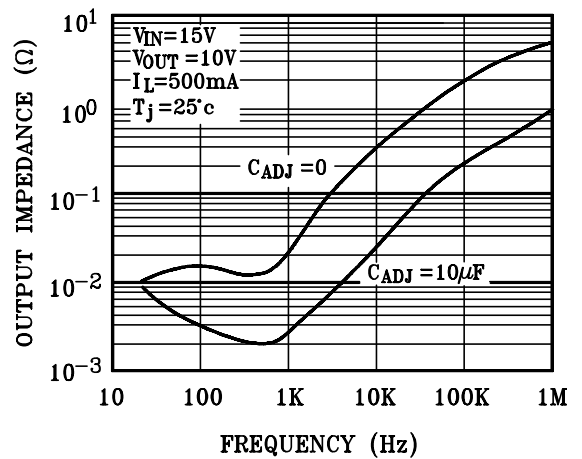

### Line Transient Response

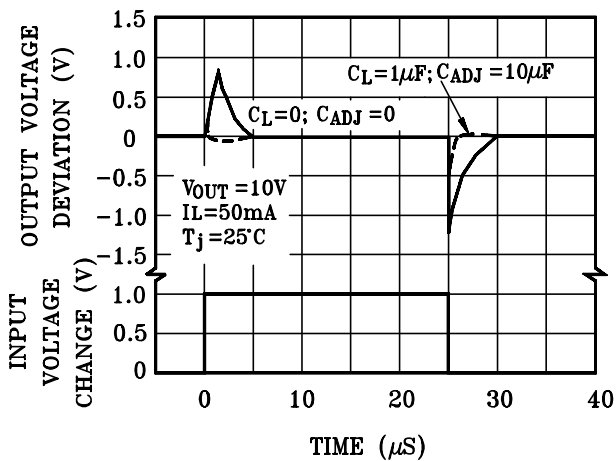

### Line Transient Response

