

Package: QFN, 32-Pin, 5mm x 5mm x 0.95mm



Features

- RF Frequency: 12GHz to 16GHz
- LO Frequency: 8GHz to 20GHz
- IF Frequency: DC to 4GHz
- Conversion Gain (Max): 23dB
- Conversion Gain (Min): -10dB
- NF (Max. Gain): 11dB
- NF (Min. Gain): 17dB
- OIP3 (Max. Gain): +28dBm
- OIP3 (Min. Gain): +12dBm
- Image Rejection: 20dBc

Applications

- Point to point
- VSAT

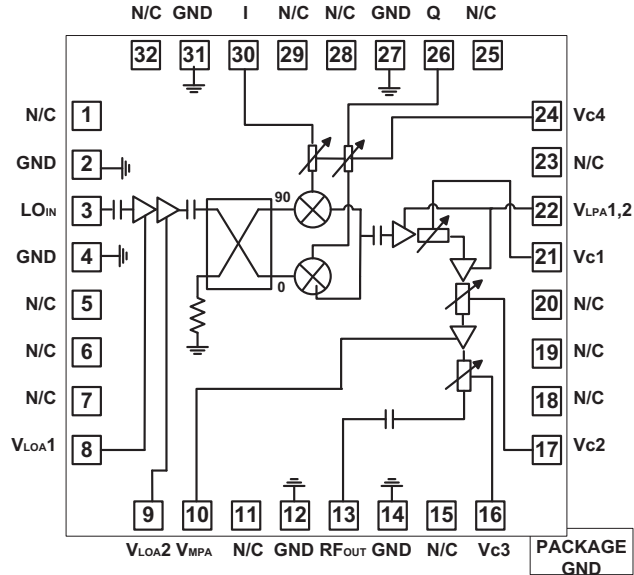

Functional Block Diagram

Product Description

RFMD's RFUV1003 is a 12GHz to 16GHz GaAs pHEMT upconverter, incorporating an integrated LO buffer amplifier, a Balanced Single Side Band (Image rejection) mixer followed by Variable Gain Amplifier, DC decoupling capacitors. The combination of high performance part and low cost packaging makes the RFUV1003 a cost effective solution, ideally suited to both current and next generation Point-to-Point and VSAT applications. RFUV1003 is packaged in a 5mm x 5mm QFN to simplify both system level board design and volume assembly.

Ordering Information

RFUV1003S2	2-piece sample bag
RFUV1003SB	5-piece bag
RFUV1003SQ	25-piece bag
RFUV1003SR	100 pieces on 7" reel
RFUV1003TR7	750 pieces on 7" reel
RFUV1003TR13	2500 pieces on 13" reel
RFUV1003PCK-410	Evaluation board with 2-piece sample bag

Optimum Technology Matching® Applied

- | | | | |
|--------------------------------------|--------------------------------------|--|------------------------------------|
| <input type="checkbox"/> GaAs HBT | <input type="checkbox"/> SiGe BiCMOS | <input checked="" type="checkbox"/> GaAs pHEMT | <input type="checkbox"/> GaN HEMT |
| <input type="checkbox"/> GaAs MESFET | <input type="checkbox"/> Si BiCMOS | <input type="checkbox"/> Si CMOS | <input type="checkbox"/> BiFET HBT |
| <input type="checkbox"/> InGaP HBT | <input type="checkbox"/> SiGe HBT | <input type="checkbox"/> Si BJT | <input type="checkbox"/> LD MOS |

RF MICRO DEVICES®, RFMD®, Optimum Technology Matching®, Enabling Wireless Connectivity™, PowerStar®, POLARIS™ TOTAL RADIO™ and UltimateBlue™ are trademarks of RFMD, LLC. BLUETOOTH is a trademark owned by Bluetooth SIG, Inc., U.S.A. and licensed for use by RFMD. All other trade names, trademarks and registered trademarks are the property of their respective owners. ©2006, RF Micro Devices, Inc.

Absolute Maximum Ratings

Parameter	Rating	Unit
LPA Drain Voltage Vd	6	V
LOA Drain Voltage	6	V
RF Input Power	15	dBm
LO Input Power	15	dBm
T _{OPER}	-40 to +85	°C
T _{STOR}	-65 to +150	°C
ESD Human Body Model	Class 1A	



Caution! ESD sensitive device.

Exceeding any one or a combination of the Absolute Maximum Rating conditions may cause permanent damage to the device. Extended application of Absolute Maximum Rating conditions to the device may reduce device reliability. Specified typical performance or functional operation of the device under Absolute Maximum Rating conditions is not implied.

The information in this publication is believed to be accurate and reliable. However, no responsibility is assumed by RF Micro Devices, Inc. ("RFMD") for its use, nor for any infringement of patents, or other rights of third parties, resulting from its use. No license is granted by implication or otherwise under any patent or patent rights of RFMD. RFMD reserves the right to change component circuitry, recommended application circuitry and specifications at any time without prior notice.



RFMD Green: RoHS compliant per EU Directive 2002/95/EC, halogen free per IEC 61249-2-21, < 1000ppm each of antimony trioxide in polymeric materials and red phosphorus as a flame retardant, and <2% antimony in solder.

Parameter	Specification			Unit	Condition
	Min.	Typ.	Max.		
RF Frequency	12		16	GHz	
LO Frequency	8		20	GHz	
IF Frequency	DC		4	GHz	
LO input Drive		0		dBm	
Conversion Gain (Max.)	20	23		dB	
Conversion Gain (Min.)		-10		dB	
NF (max. Gain)		11		dB	
NF (min. Gain)		17		dB	
OIP3 (max. Gain)	25	28		dBm	
OIP3 (min. Gain)	9	12		dBm	
Image Rejection	15	20		dBc	
LO Leakage at RF-Port (Maximum Gain)		-5	5	dBm	With IQ bias
LO Return Loss		10		dB	
RF Return Loss		10		dB	
V _D		5		V	
I _D		380	500	mA	
VVA	-3		0	V	

Typical Electrical Performance

Measurements performed with I and Q (IF) ports connected to an external 90° Hybrid, LO Power= 0dBm and IF =2.5GHz, -10dBm, unless otherwise stated.

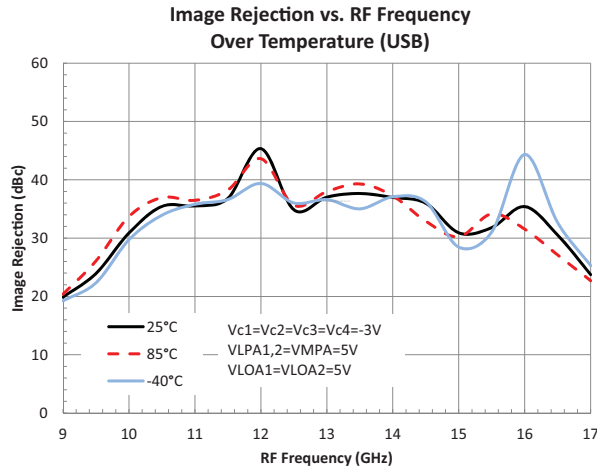
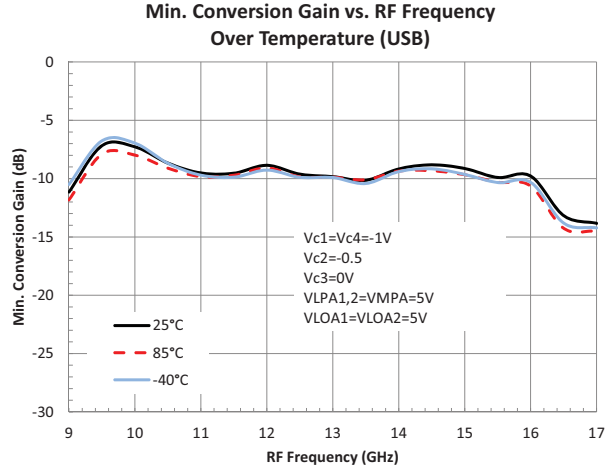
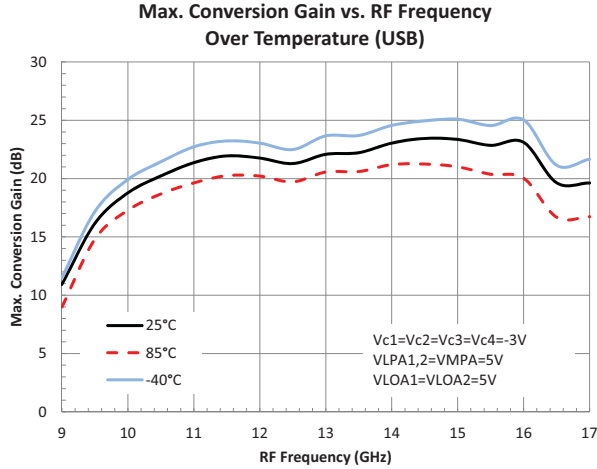

Typical Electrical Performance

Measurements performed with I and Q (IF) ports connected to an external 90° Hybrid, LO Power= 0dBm and IF =2.5GHz, -10dBm, unless otherwise stated.

Noise Figure vs. RF Frequency at 20dB Conversion Gain Over Temperature (USB)

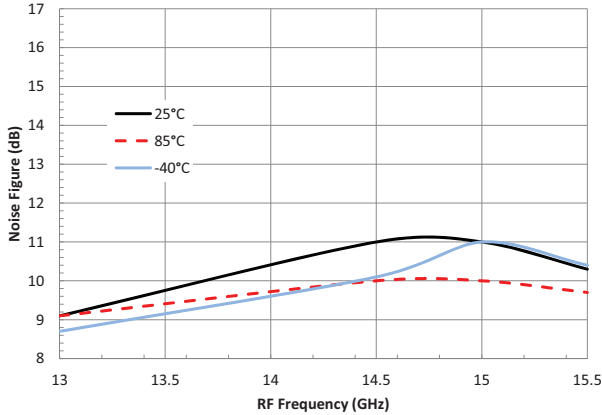

Noise Figure vs. RF Frequency at -5dB Conversion Gain Over Temperature (USB)

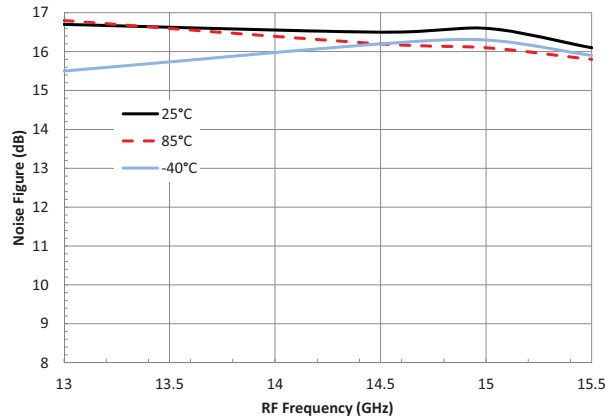

OIP3 vs. Conversion Gain at 25°C (USB 15GHz Band)

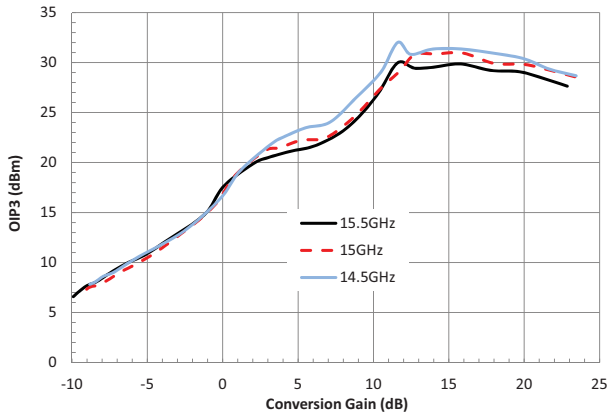

OIP3 vs. Conversion Gain at 25°C (USB 13GHz Band)

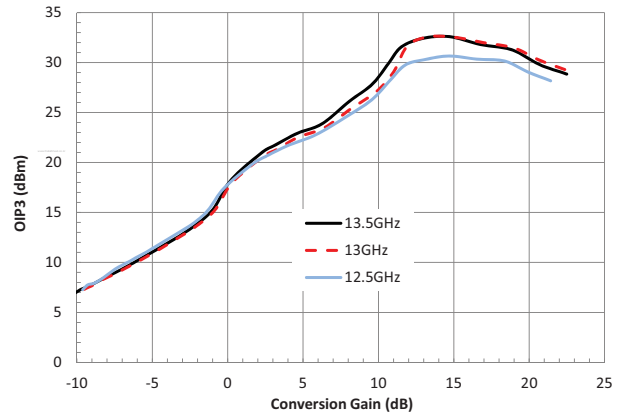

Typical Electrical Performance

Measurements performed with I and Q (IF) ports connected to an external 90° Hybrid, LO Power= 0dBm and IF =2.5GHz, -10dBm, unless otherwise stated.

**OIP3 vs. Conversion Gain at -40°C
(USB 15GHz Band)**

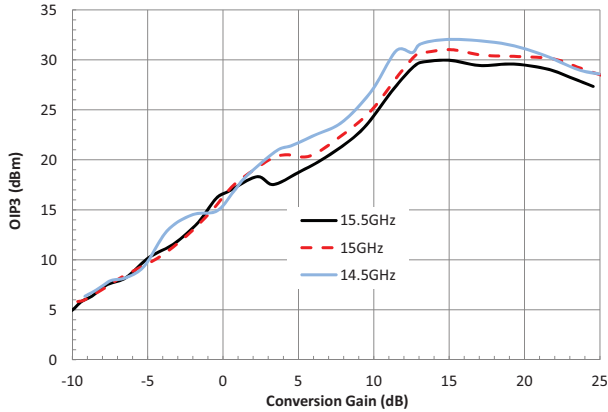

**OIP3 vs. Conversion Gain at -40°C
(USB 13GHz Band)**

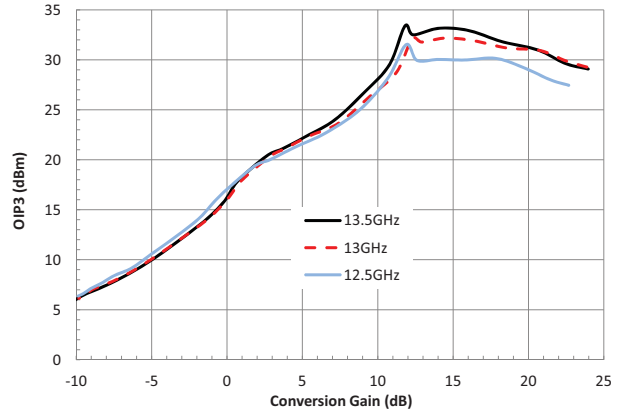

**OIP3 vs. Conversion Gain at 85°C
(USB 15GHz Band)**

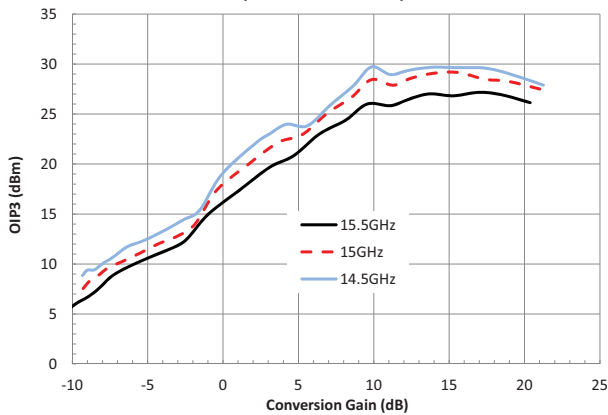

**OIP3 vs. Conversion Gain at 85°C
(USB 13GHz Band)**

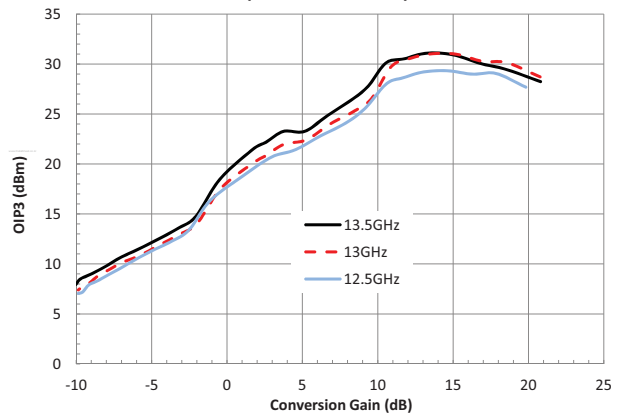

Typical Electrical Performance

Measurements performed with I and Q (IF) ports connected to an external 90° Hybrid, LO Power= 0dBm and IF =2.5GHz, -10dBm, unless otherwise stated.

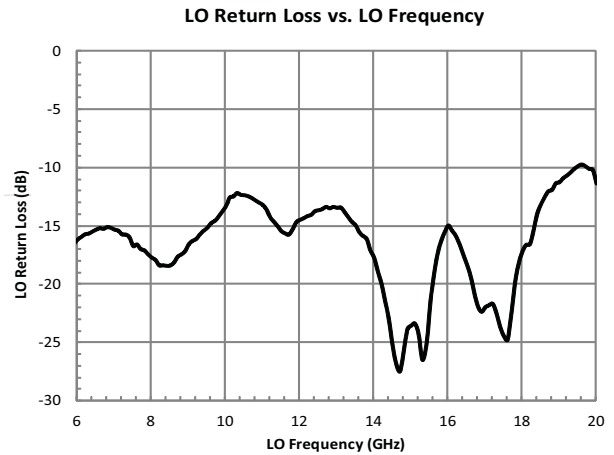
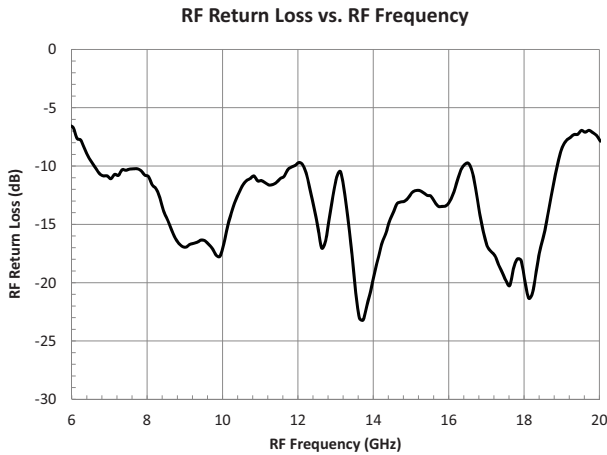
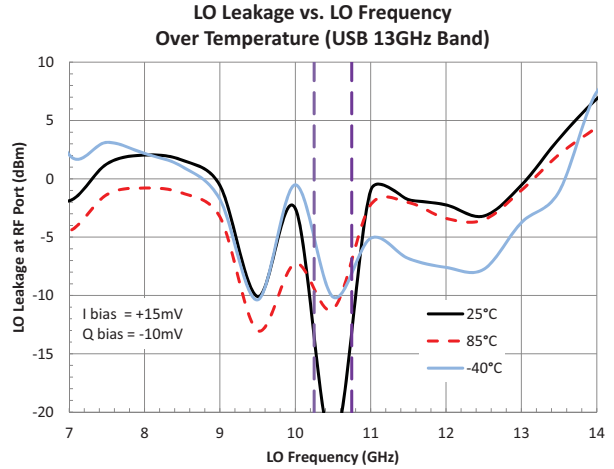
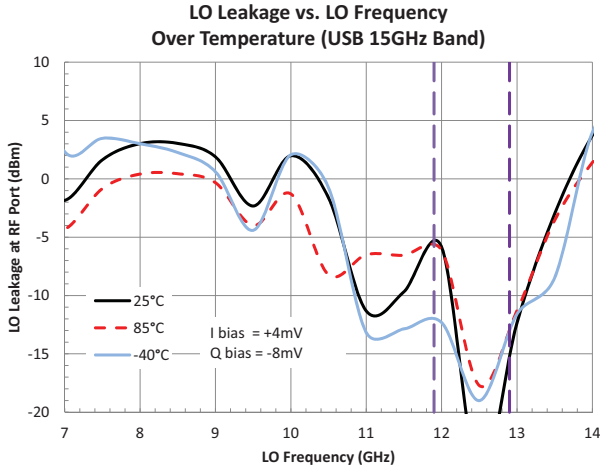

Bias Sequence and Gain Control

Optimum performance is achieved using sequential bias. At maximum gain (V_{C1}, V_{C4}), V_{C2} and V_{C3} are set at -3V. (V_{C1}, V_{C4}), V_{C2} and V_{C3} are biased in sequence. The first dynamic range is achieved by setting V_{C2} and V_{C3} at -3V and varying (V_{C1}, V_{C4}) over the (-3V to -1V) range as shown in the table below. Similarly second dynamic range is achieved by setting (V_{C1}, V_{C4}) at -1V, V_{C3} at -3V and varying V_{C2} over the (-3V to -0.5V) range. Finally third dynamic range is achieved by setting (V_{C1}, V_{C4}) at -1V, V_{C2} at -0.5V and varying V_{C3} over the (-3V to 0V) range.

Bias Sequence 1 (Typical)

	Gmax														Gmin
	-3	-2.5	-2	-1.5	-1	-1	-1	-1	-1	-1	-1	-1	-1	-1	
VC1, VC4	-3	-2.5	-2	-1.5	-1	-1	-1	-1	-1	-1	-1	-1	-1	-1	-1
VC2	-3	-3	-3	-3	-3	-2.5	-2	-1.5	-0.5	-0.5	-0.5	-0.5	-0.5	-0.5	-0.5
VC3	-3	-3	-3	-3	-3	-3	-3	-3	-3	-2.5	-2	-1.5	-1	-0.5	0

Package Outline Drawing
QFN, 32-Pin, 5mm x 5mm x 0.95mm

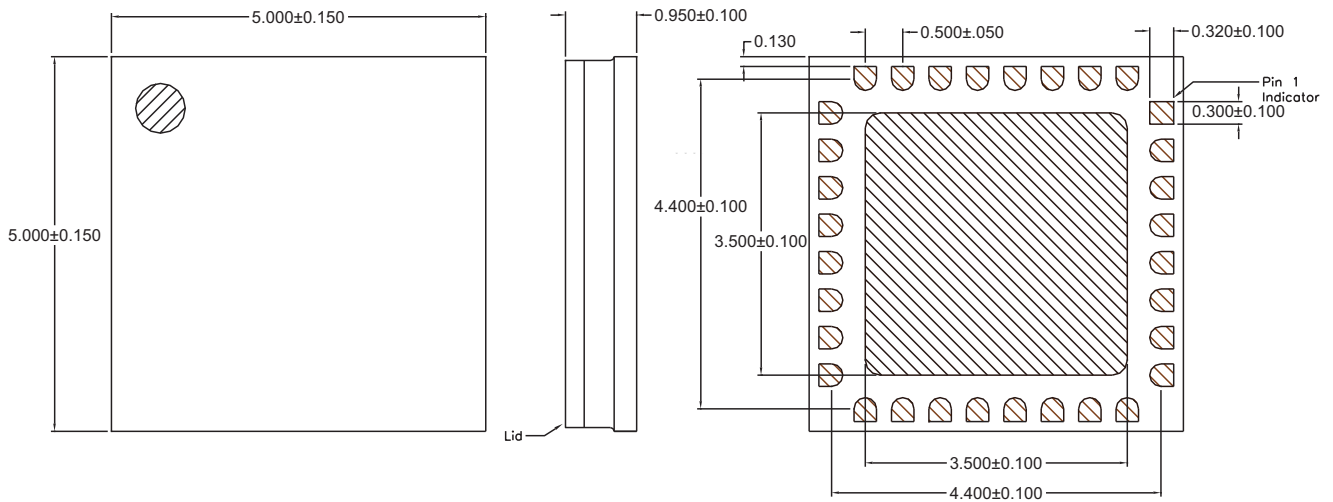

Pin Names and Description

Pin	Function	Description
1	N/C	
2	GND	Ground
3	LO	Local Oscillator Input. AC Coupled and Matched to 50Ω
4	GND	Ground
5	N/C	
6	N/C	
7	N/C	
8	VLOA1	LOA Stage1 Drain Bias
9	VLOA2	LOA Stage2 Drain Bias
10	VMPA	MPA Drain Bias
11	N/C	
12	GND	Ground
13	RFOUT	RF Output. AC Coupled and Matched to 50W
14	GND	Ground
15	N/C	
16	VC3	Control Line number3 (See Bias Sequence description)
17	VC2	Control Line number2 (See Bias Sequence description)
18	N/C	
19	N/C	
20	N/C	
21	VC1	Control Line number1 (See Bias Sequence description)
22	VLPA1, VLPA2	LPA Stage1,2 Drain Bias
23	N/C	
24	VC4	Control Line number4 (See Bias Sequence description)
25	N/C	
26	Q	IF Q Input
27	GND	Ground
28	N/C	
29	N/C	
30	I	IF I Input
31	GND	Ground
32	N/C	

Evaluation Board Layout

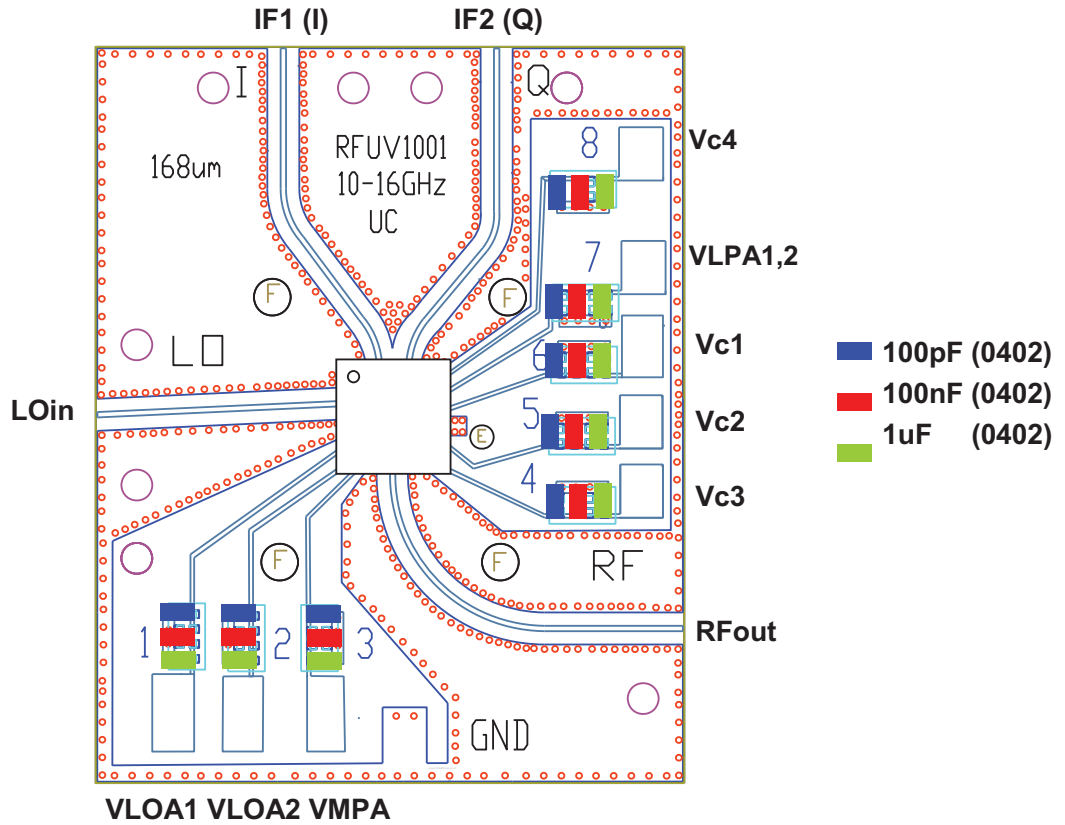

Test Condition

LO Power	0dBm
IF Power	-10dBm
VLOA1, VLOA2	5V
VLPA1, VLPA2, VMPA	5V
(V _{C1} , V _{C4}), V _{C2} , V _{C3}	-3V to 0V

Sub-Band Frequency Ranges

Band	Frequency Range
10GHz	10GHz to 10.5GHz
11GHz	10.7GHz to 11.7GHz
13GHz	12.75GHz to 13.25GHz
15GHz	14.4GHz to 15.4GHz