

Frequency Synthesizer

KSN-700A-3C19+

50Ω 700 MHz (fixed)

The Big Deal

- Low phase noise and spurious
- Fixed frequency without external programming
- Integrated microcontroller
- Robust design and construction
- Small size 0.80" x 0.58" x 0.15"



CASE STYLE: DK1042

Product Overview

The KSN-700A-3C19+ is a Frequency Synthesizer, designed to operate 700MHz for aircraft communication equipment application. The KSN-700A-3C19+ is packaged in a metal case (size of 0.80" x 0.58" x 0.15") to shield against unwanted signals and noise.

Key Features

Feature	Advantages
Low phase noise and spurious: <ul style="list-style-type: none">• Phase noise: -110 dBc/Hz typ. @ 10 kHz offset• Comparison spurious: -87 dBc typ.• Reference spurious: -85 dBc typ.	Low phase noise and spurious improve system EVM (Error Vector Magnitude).
Robust design and construction	To enhance the robustness of KSN-700A-3C19+, each internal component is secured to the substrate with chip bonder, thereby eliminating the risk of tombstoning during subsequent solder reflow operations by the customer.
Small size, 0.80" x 0.58" x 0.15"	The small size enables the KSN-700A-3C19+ to be used in compact designs.



IF/RF MICROWAVE COMPONENTS • ISO 9001 ISO 14001 AS 9100 CERTIFIED RoHS compliant
P.O. Box 350166, Brooklyn, New York 11235-0003 (718) 934-4500 Fax (718) 332-4661



The Design Engineers Search Engine finds the model you need, Instantly • For detailed performance specs & shopping online see minicircuits.com

Notes: 1. Performance and quality attributes and conditions not expressly stated in this specification sheet are intended to be excluded and do not form a part of this specification sheet. 2. Electrical specifications and performance data contained herein are based on Mini-Circuit's applicable established test performance criteria and measurement instructions. 3. The parts covered by this specification sheet are subject to Mini-Circuits standard limited warranty and terms and conditions (collectively, "Standard Terms"); Purchasers of this part are entitled to the rights and benefits contained therein. For a full statement of the Standard Terms and the exclusive rights and remedies thereunder, please visit Mini-Circuits' website at www.minicircuits.com/MCLStore/terms.jsp.

50Ω 700 MHz (fixed)

Features

- Fixed frequency without external programming
- Integrated microcontroller
- High reliability over temperature changes
- Robust design and construction
- Low operating voltage (VCC VCO=+5V, VCC PLL=+5V)
- Small size 0.80" x 0.58" x 0.15"

Applications

- Aircraft communication equipment



CASE STYLE: DK1042
PRICE: \$29.95 ea. QTY (1-9)

+ RoHS compliant in accordance with EU Directive (2002/95/EC)

The +Suffix has been added in order to identify RoHS Compliance. See our web site for RoHS Compliance methodologies and qualifications.

General Description

The KSN-700A-3C19+ is a Frequency Synthesizer, designed to operate 700MHz for aircraft communication equipment application. The KSN-700A-3C19+ is packaged in a metal case (size of 0.80" x 0.58" x 0.15") to shield against unwanted signals and noise. To enhance the robustness of KSN-700A-3C19+, each internal component is secured to the substrate with chip bonder, thereby eliminating the risk of tombstoning during subsequent solder reflow operations by the customer.

Simplified Schematic

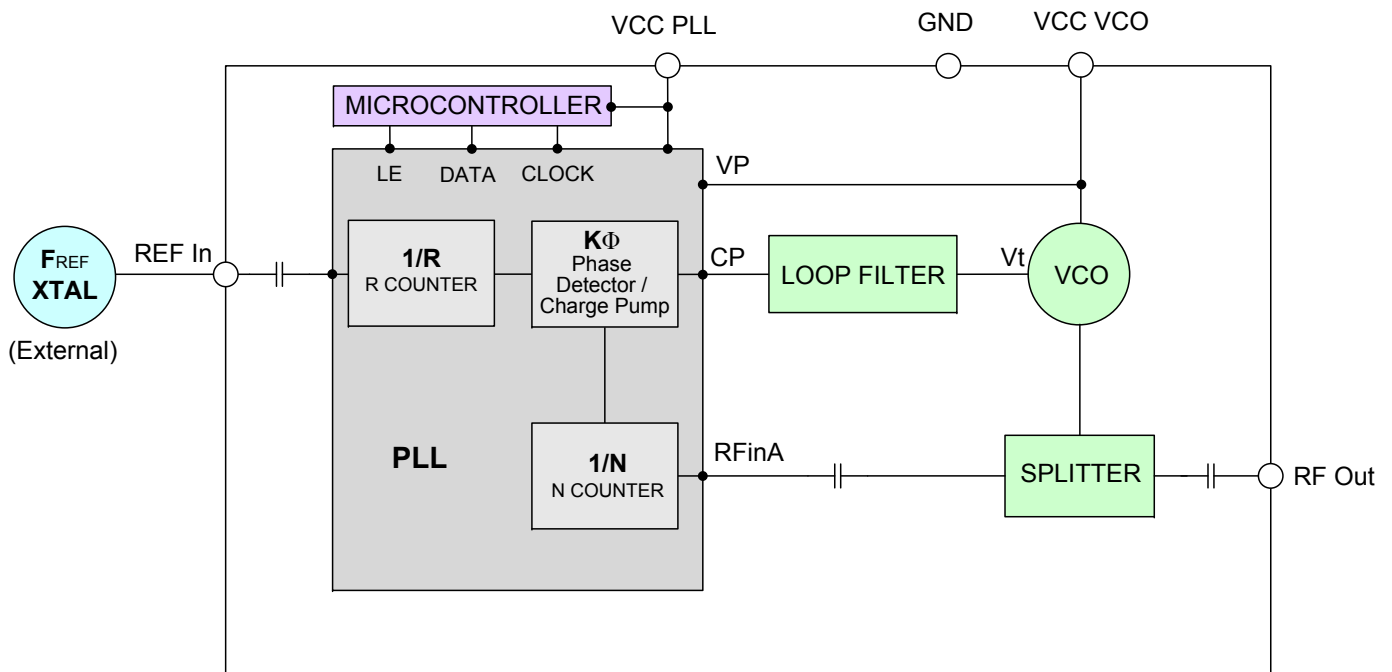

IF/RF MICROWAVE COMPONENTS • ISO 9001 ISO 14001 AS9100 CERTIFIED RoHS compliant
P.O. Box 350166, Brooklyn, New York 11235-0003 (718) 934-4500 Fax (718) 332-4661



The Design Engineers Search Engine finds the model you need, Instantly • For detailed performance specs & shopping online see minicircuits.com

Notes: 1. Performance and quality attributes and conditions not expressly stated in this specification sheet are intended to be excluded and do not form a part of this specification sheet. 2. Electrical specifications and performance data contained herein are based on Mini-Circuit's applicable established test performance criteria and measurement instructions. 3. The parts covered by this specification sheet are subject to Mini-Circuits standard limited warranty and terms and conditions (collectively, "Standard Terms"); Purchasers of this part are entitled to the rights and benefits contained therein. For a full statement of the Standard Terms and the exclusive rights and remedies thereunder, please visit Mini-Circuits' website at www.minicircuits.com/MCLStore/terms.jsp.

Electrical Specifications (over operating temperature -40°C to +85°C)

Parameters	Test Conditions	Min.	Typ.	Max.	Units	
Frequency Range (fixed)	-	700	-	700	MHz	
Comparison frequency	-	-	5	-	MHz	
Settling Time (Power on to lock)	Within ± 1 kHz	-	30	-	mSec	
Output Power	-	+4.5	+6.5	+8.5	dBm	
SSB Phase Noise	@ 100 Hz offset	-	-96	-	dBc/Hz	
	@ 1 kHz offset	-	-98	-93		
	@ 10 kHz offset	-	-110	-105		
	@ 100 kHz offset	-	-135	-130		
	@ 1 MHz offset	-	-155	-150		
Reference Spurious Suppression	Ref. Freq. 10 MHz	-	-85	-70	dBc	
Comparison Spurious Suppression	Comparison frequency 5 MHz	-	-87	-72		
Non - Harmonic Spurious Suppression	-	-	-90	-		
Harmonic Suppression	-	-	-20	-15	dBc	
VCO Supply Voltage	+5.00	+4.75	+5.00	+5.25	V	
PLL Supply Voltage	+5.00	+4.75	+5.00	+5.25		
VCO Supply Current	-	-	38	45	mA	
PLL Supply Current	-	-	12	19		
Reference Input (External)	Frequency	10 (square wave)	-	10	-	MHz
	Amplitude	1	-	1	-	V _{p-p}
	Input impedance	-	-	100	-	KΩ
	Phase Noise @ 1 kHz offset	-	-	-145	-	dBc/Hz
RF Output port Impedance	-	-	50	-	Ω	
Digital Lock Detect	Locked	-	4.35	-	5.25	V
	Unlocked	-	-	-	0.40	V

Absolute Maximum Ratings

Parameters	Ratings
VCO Supply Voltage	6V
PLL Supply Voltage	6V
VCO Supply Voltage to PLL Power Supply	-0.3V to +5.5V
Reference Frequency Voltage	-0.3Vmin, VCC PLL +0.3Vmax
Data, Clock, LE Levels	N.A.
Operating Temperature	-40°C to +85°C
Storage Temperature	-55°C to +100°C

Permanent damage may occur if any of these limits are exceeded



IF/RF MICROWAVE COMPONENTS • ISO 9001 ISO 14001 AS9100 CERTIFIED RoHS compliant
 P.O. Box 350166, Brooklyn, New York 11235-0003 (718) 934-4500 Fax (718) 332-4661

The Design Engineers Search Engine finds the model you need, Instantly • For detailed performance specs & shopping online see minicircuits.com

Notes: 1. Performance and quality attributes and conditions not expressly stated in this specification sheet are intended to be excluded and do not form a part of this specification sheet. 2. Electrical specifications and performance data contained herein are based on Mini-Circuit's applicable established test performance criteria and measurement instructions. 3. The parts covered by this specification sheet are subject to Mini-Circuits standard limited warranty and terms and conditions (collectively, "Standard Terms"); Purchasers of this part are entitled to the rights and benefits contained therein. For a full statement of the Standard Terms and the exclusive rights and remedies thereunder, please visit Mini-Circuits' website at www.minicircuits.com/MCLStore/terms.jsp.

Typical Performance Data

FREQUENCY (MHz)	POWER OUTPUT (dBm)			VCO CURRENT (mA)			PLL CURENT (mA)		
	-45°C	+25°C	+85°C	-45°C	+25°C	+85°C	-45°C	+25°C	+85°C
	700	6.30	6.56	6.58	35.75	38.23	39.51	9.93	11.93

FREQUENCY (MHz)	HARMONICS (dBc)					
	F2			F3		
	-45°C	+25°C	+85°C	-45°C	+25°C	+85°C
700	-19.09	-19.86	-21.08	-22.93	-25.08	-27.64

FREQUENCY (MHz)	@TEMP.	PHASE NOISE (dBc/Hz)				
		@OFFSETS				
		100Hz	1kHz	10kHz	100kHz	1MHz
700	-45°C	-99.01	-98.87	-111.60	-137.78	-157.74
	+25°C	-98.90	-98.71	-111.85	-136.40	-156.44
	+85°C	-95.07	-97.88	-110.14	-134.34	-154.64

COMPARISON SPURIOUS ORDER	COMPARISON SPURIOUS @Fcarrier 700MHz+(n*Fcomparison) (dBc) note 1		
	-45°C	+25°C	+85°C
n			
-5	-90.19	-90.60	-95.57
-4	-89.28	-91.85	-99.43
-3	-90.16	-92.82	-104.75
-2	-88.65	-95.85	-102.04
-1	-87.21	-98.08	-94.36
0 note 2	-	-	-
+1	-100.02	-94.07	-90.21
+2	-106.44	-94.10	-88.89
+3	-102.88	-91.85	-88.07
+4	-101.75	-91.87	-87.38
+5	-98.17	-90.99	-87.56

REFERENCE SPURIOUS ORDER	REFERENCE SPURIOUS @Fcarrier 700MHz+(n*Freference) (dBc) note 3		
	-45°C	+25°C	+85°C
n			
-5	-85.76	-88.44	-91.58
-4	-87.14	-90.09	-92.55
-3	-88.50	-89.94	-94.14
-2	-89.34	-91.88	-99.74
-1	-88.53	-95.82	-101.11
0 note 4	-	-	-
+1	-106.12	-93.98	-88.89
+2	-102.12	-91.93	-87.44
+3	-95.76	-90.80	-87.32
+4	-94.06	-90.82	-87.93
+5	-93.43	-91.11	-89.15

Note 1: Comparison frequency 5 MHz
 Note 2: All spurs are referenced to carrier signal (n=0).

Note 3: Reference frequency 10 MHz
 Note 4: All spurs are referenced to carrier signal (n=0).



IF/RF MICROWAVE COMPONENTS • ISO 9001 ISO 14001 AS9100 CERTIFIED RoHS compliant
 P.O. Box 350166, Brooklyn, New York 11235-0003 (718) 934-4500 Fax (718) 332-4661
 The Design Engineers Search Engine finds the model you need, Instantly • For detailed performance specs & shopping online see minicircuits.com

Notes: 1. Performance and quality attributes and conditions not expressly stated in this specification sheet are intended to be excluded and do not form a part of this specification sheet. 2. Electrical specifications and performance data contained herein are based on Mini-Circuit's applicable established test performance criteria and measurement instructions. 3. The parts covered by this specification sheet are subject to Mini-Circuits standard limited warranty and terms and conditions (collectively, "Standard Terms"); Purchasers of this part are entitled to the rights and benefits contained therein. For a full statement of the Standard Terms and the exclusive rights and remedies thereunder, please visit Mini-Circuits' website at www.minicircuits.com/MCLStore/terms.jsp.

Typical Performance Curves

OUTPUT POWER Vs FREQUENCY

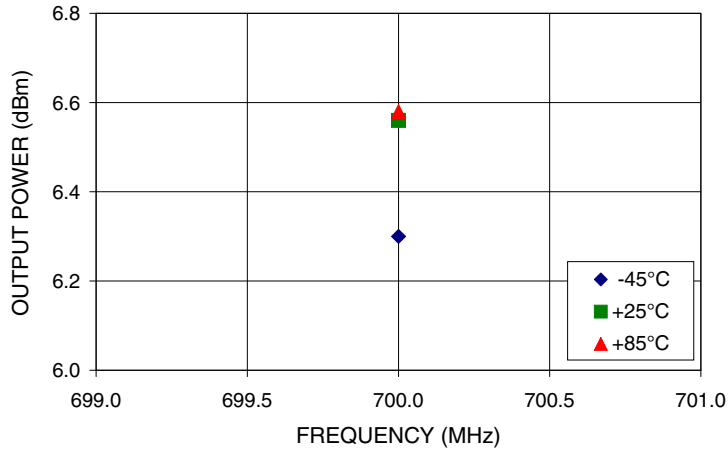

2nd HARMONIC Vs FREQUENCY

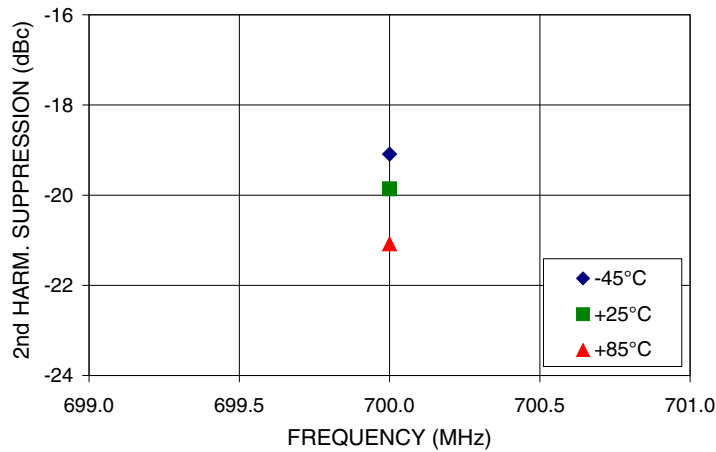

3rd HARMONIC Vs FREQUENCY

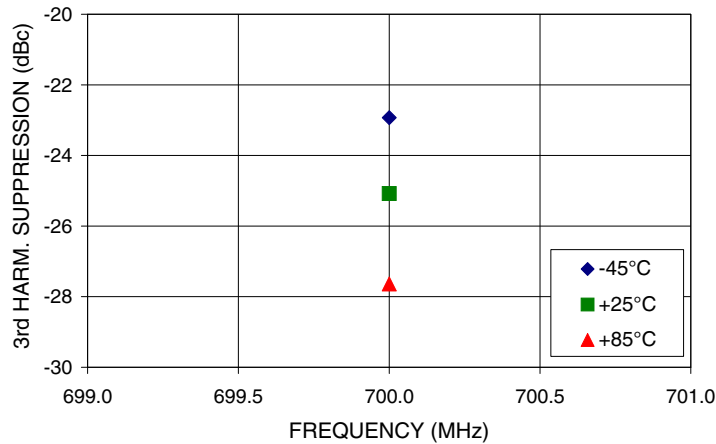

IF/RF MICROWAVE COMPONENTS • ISO 9001 ISO 14001 AS9100 CERTIFIED RoHS compliant
 P.O. Box 350166, Brooklyn, New York 11235-0003 (718) 934-4500 Fax (718) 332-4661



The Design Engineers Search Engine finds the model you need, Instantly • For detailed performance specs & shopping online see



Notes: 1. Performance and quality attributes and conditions not expressly stated in this specification sheet are intended to be excluded and do not form a part of this specification sheet. 2. Electrical specifications and performance data contained herein are based on Mini-Circuit's applicable established test performance criteria and measurement instructions. 3. The parts covered by this specification sheet are subject to Mini-Circuits standard limited warranty and terms and conditions (collectively, "Standard Terms"); Purchasers of this part are entitled to the rights and benefits contained therein. For a full statement of the Standard Terms and the exclusive rights and remedies thereunder, please visit Mini-Circuits' website at www.minicircuits.com/MCLStore/terms.jsp.

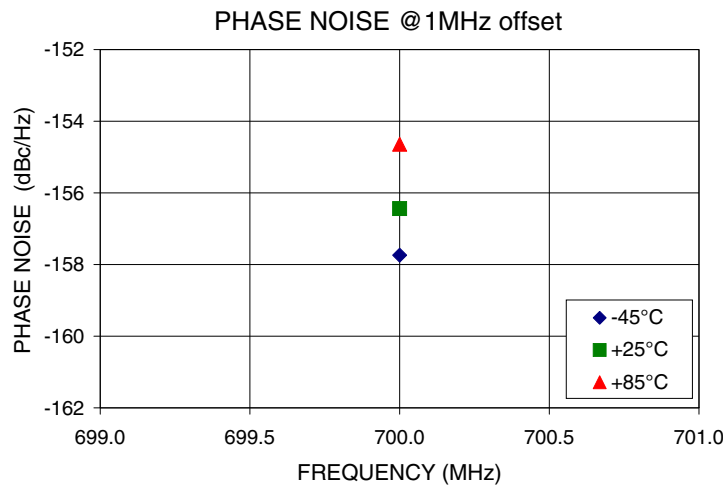
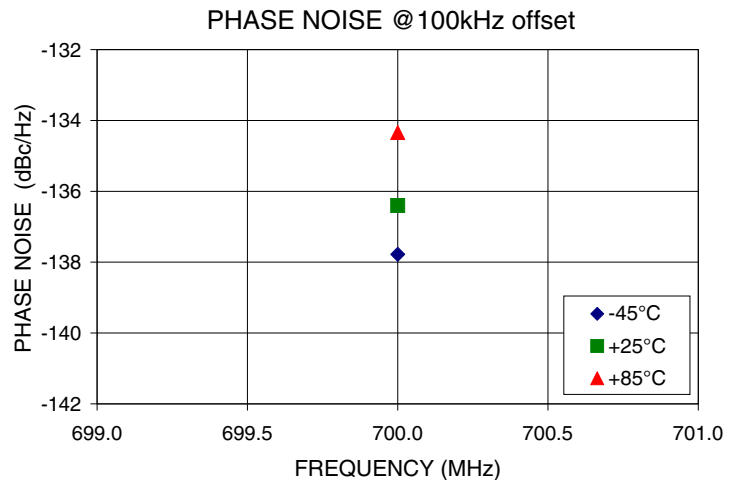
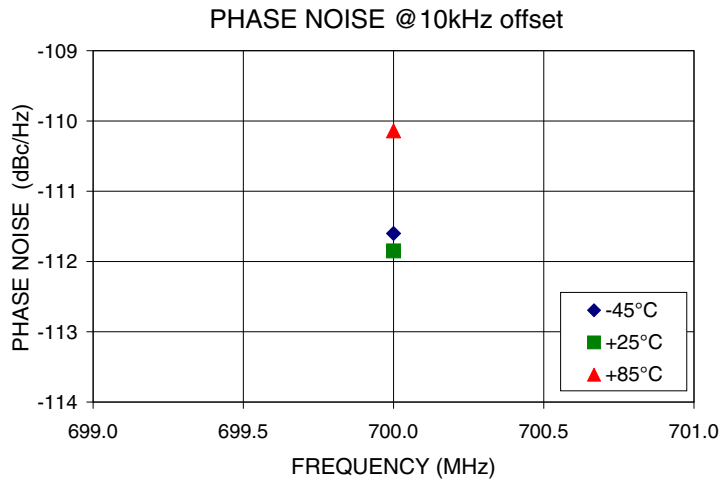
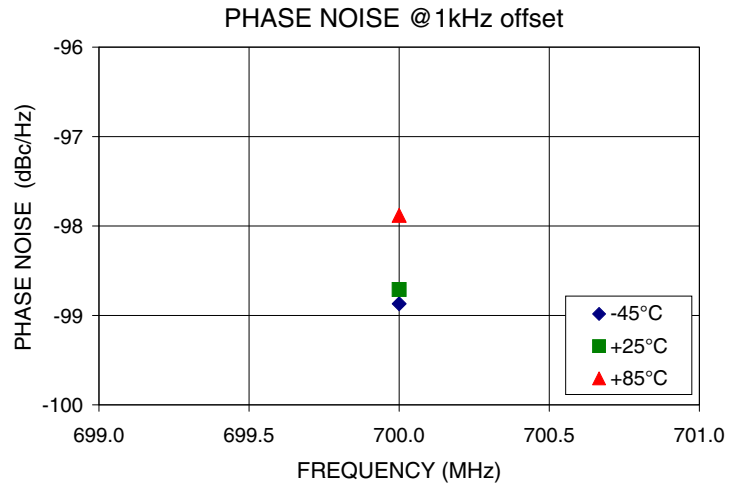
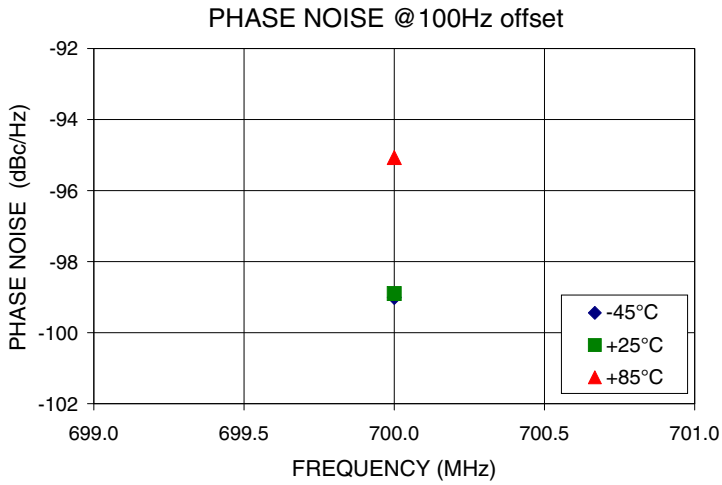

IF/RF MICROWAVE COMPONENTS • ISO 9001 ISO 14001 AS9100 CERTIFIED RoHS compliant
 P.O. Box 350166, Brooklyn, New York 11235-0003 (718) 934-4500 Fax (718) 332-4661



The Design Engineers Search Engine finds the model you need, Instantly • For detailed performance specs & shopping online see



Notes: 1. Performance and quality attributes and conditions not expressly stated in this specification sheet are intended to be excluded and do not form a part of this specification sheet. 2. Electrical specifications and performance data contained herein are based on Mini-Circuit's applicable established test performance criteria and measurement instructions. 3. The parts covered by this specification sheet are subject to Mini-Circuits standard limited warranty and terms and conditions (collectively, "Standard Terms"); Purchasers of this part are entitled to the rights and benefits contained therein. For a full statement of the Standard Terms and the exclusive rights and remedies thereunder, please visit Mini-Circuits' website at www.minicircuits.com/MCLStore/terms.jsp.

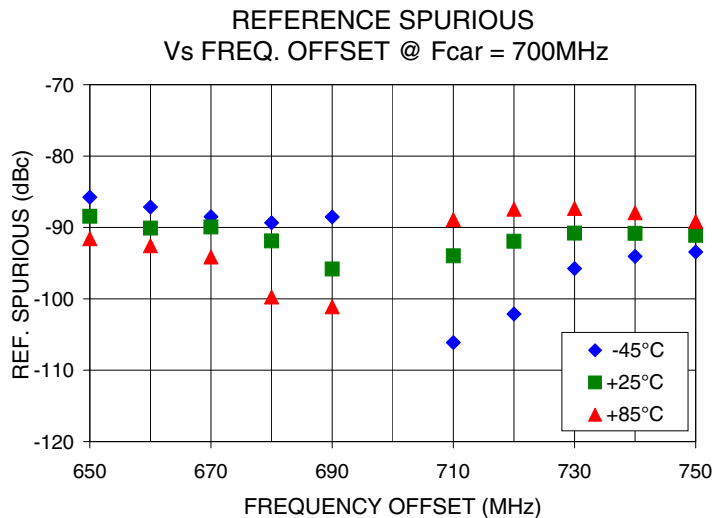
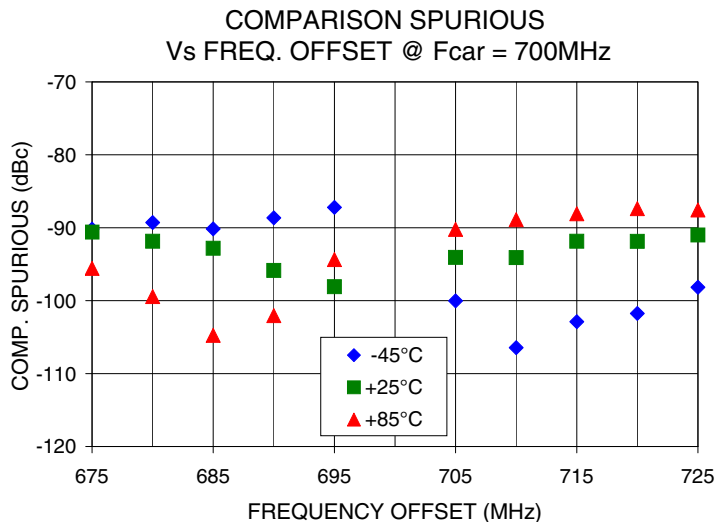

IF/RF MICROWAVE COMPONENTS • ISO 9001 ISO 14001 AS9100 CERTIFIED RoHS compliant
 P.O. Box 350166, Brooklyn, New York 11235-0003 (718) 934-4500 Fax (718) 332-4661



The Design Engineers Search Engine finds the model you need, Instantly • For detailed performance specs & shopping online see



Notes: 1. Performance and quality attributes and conditions not expressly stated in this specification sheet are intended to be excluded and do not form a part of this specification sheet. 2. Electrical specifications and performance data contained herein are based on Mini-Circuit's applicable established test performance criteria and measurement instructions. 3. The parts covered by this specification sheet are subject to Mini-Circuits standard limited warranty and terms and conditions (collectively, "Standard Terms"); Purchasers of this part are entitled to the rights and benefits contained therein. For a full statement of the Standard Terms and the exclusive rights and remedies thereunder, please visit Mini-Circuits' website at www.minicircuits.com/MCLStore/terms.jsp.

Pin Configuration

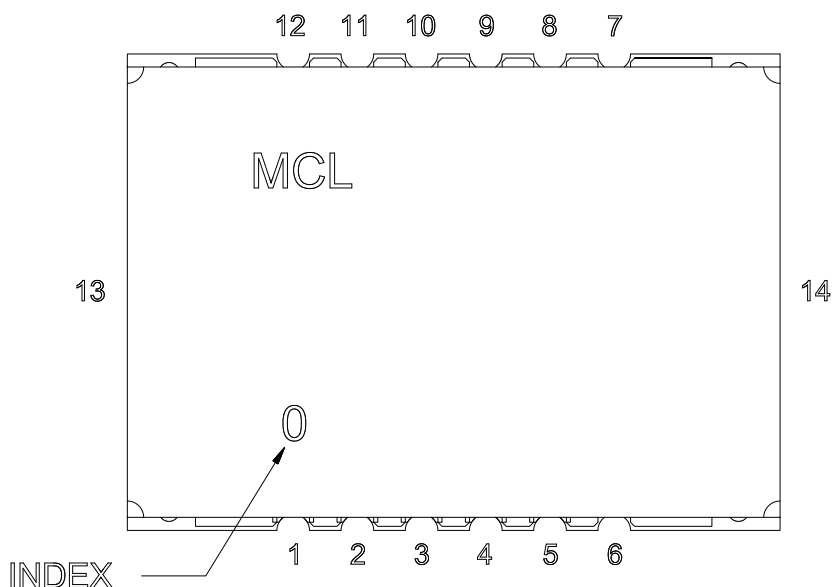

Pin Connection

Pin Number	Function
1	VCC PLL
2	GND
3	REF IN
4	GND
5	VCC VCO
6	GND
7	RF OUT
8	GND
9	LOCK DET
10	NOT CONNECTED
11	NOT CONNECTED
12	NOT CONNECTED
13	GND
14	GND

Recommended Application Circuit

Note: REF IN and RF OUT ports are internally AC coupled.

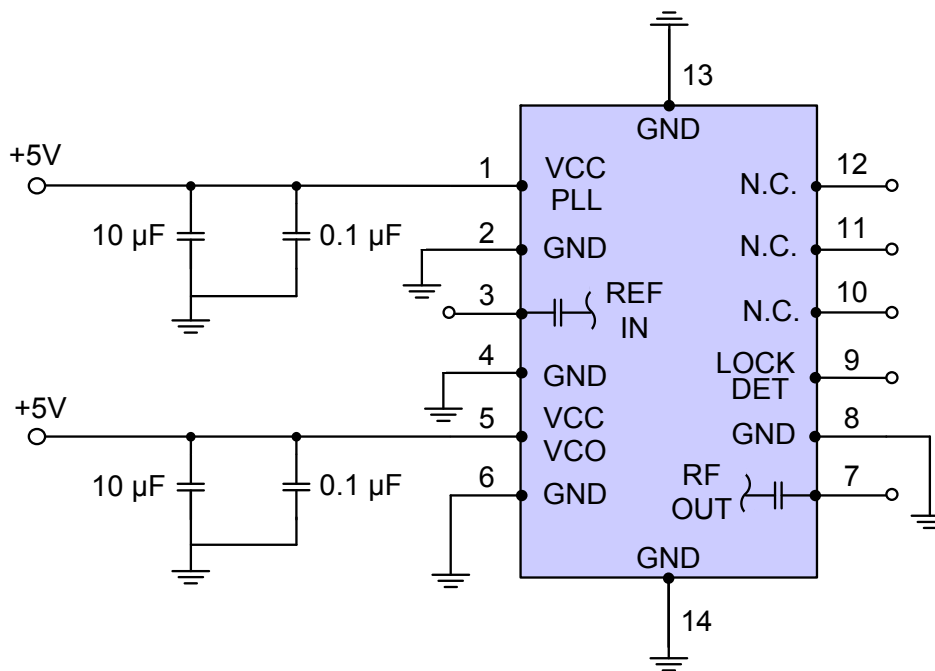

IF/RF MICROWAVE COMPONENTS • ISO 9001 ISO 14001 AS9100 CERTIFIED RoHS compliant
 P.O. Box 350166, Brooklyn, New York 11235-0003 (718) 934-4500 Fax (718) 332-4661



The Design Engineers Search Engine finds the model you need, Instantly • For detailed performance specs & shopping online see



Notes: 1. Performance and quality attributes and conditions not expressly stated in this specification sheet are intended to be excluded and do not form a part of this specification sheet. 2. Electrical specifications and performance data contained herein are based on Mini-Circuit's applicable established test performance criteria and measurement instructions. 3. The parts covered by this specification sheet are subject to Mini-Circuits standard limited warranty and terms and conditions (collectively, "Standard Terms"); Purchasers of this part are entitled to the rights and benefits contained therein. For a full statement of the Standard Terms and the exclusive rights and remedies thereunder, please visit Mini-Circuits' website at www.minicircuits.com/MCLStore/terms.jsp.

Device Marking

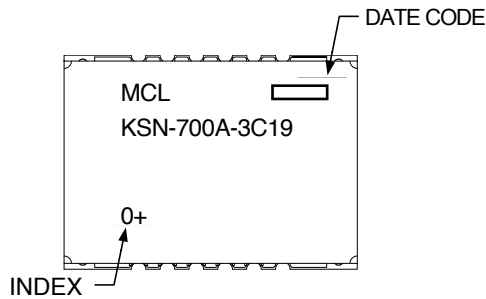

Additional Detailed Technical Information

Additional information is available on our web site. To access this information enter the model number on our web site home page.

Case Style: DK1042

Tape & Reel: TR-F28

Suggested Layout for PCB Design: PL-249

Evaluation Board: TB-567+F

Environment Ratings: ENV03T2



IF/RF MICROWAVE COMPONENTS • ISO 9001 ISO 14001 AS9100 CERTIFIED RoHS compliant
P.O. Box 350166, Brooklyn, New York 11235-0003 (718) 934-4500 Fax (718) 332-4661



The Design Engineers Search Engine finds the model you need, Instantly • For detailed performance specs & shopping online see



Notes: 1. Performance and quality attributes and conditions not expressly stated in this specification sheet are intended to be excluded and do not form a part of this specification sheet. 2. Electrical specifications and performance data contained herein are based on Mini-Circuit's applicable established test performance criteria and measurement instructions. 3. The parts covered by this specification sheet are subject to Mini-Circuits standard limited warranty and terms and conditions (collectively, "Standard Terms"); Purchasers of this part are entitled to the rights and benefits contained therein. For a full statement of the Standard Terms and the exclusive rights and remedies thereunder, please visit Mini-Circuits' website at www.minicircuits.com/MCLStore/terms.jsp.