

PLEASE CHECK WWW.MOLEX.COM FOR LATEST PART INFORMATION

Part Number: [0702474851](#)
Status: **Active**
Overview: [cgrid_sl_products](#)
Description: 2.54mm (.100") Pitch C-Grid® Header, Dual Row, Low Profile, Right Angle, Shrouded, 48 Circuits, 0.38µm (15µ") Gold (Au) Selective Plating, Tin (Sn) PC Tail Plating

Documents:

[3D Model](#) [Product Specification PS-70246-100 \(PDF\)](#)
[Drawing \(PDF\)](#) [RoHS Certificate of Compliance \(PDF\)](#)
[Product Specification PS-70246 \(PDF\)](#)

Agency Certification

CSA LR19980
 UL E29179

General

Product Family PCB Headers
 Series [70247](#)
 Application Wire-to-Board
 Overview [cgrid_sl_products](#)
 Product Name C-Grid®

Physical

Breakaway No
 Circuits (Loaded) 48
 Circuits (maximum) 48
 Color - Resin Black
 Durability (mating cycles max) 50
 First Mate / Last Break No
 Flammability 94V-0
 Glow-Wire Compliant No
 Guide to Mating Part No
 Keying to Mating Part None
 Lock to Mating Part None
 Material - Plating Mating Gold
 Material - Plating Termination Tin
 Material - Resin Polyester
 Number of Rows 2
 Orientation Right Angle
 PC Tail Length (in) 0.120 In
 PC Tail Length (mm) 3.05 mm
 PCB Locator No
 PCB Retention None
 PCB Thickness Recommended (in) 0.062 In
 PCB Thickness Recommended (mm) 1.60 mm
 Packaging Type Tray
 Pitch - Mating Interface (in) 0.100 In
 Pitch - Mating Interface (mm) 2.54 mm
 Plating min: Mating (µin) 15.2
 Plating min: Mating (µm) 0.38
 Plating min: Termination (µin) 75.2
 Plating min: Termination (µm) 1.88
 Polarized to Mating Part Center Slot
 Shrouded Fully
 Stackable No
 Temperature Range - Operating -55°C to +120°C

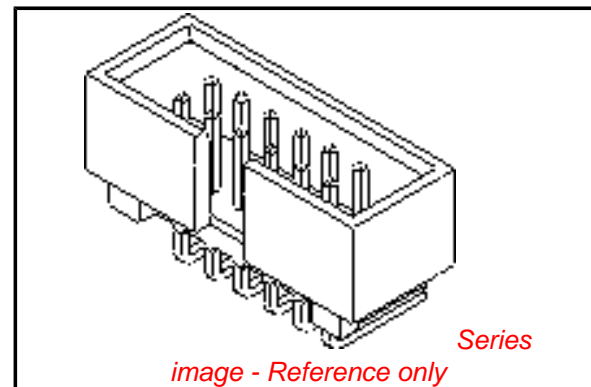

EU RoHS

**ELV and RoHS
 Compliant**
**REACH SVHC
 Contains SVHC: No**
**Halogen-Free
 Status
 Not Reviewed**

China RoHS



**Need more information on product
 environmental compliance?**

Email productcompliance@molex.com
 For a multiple part number RoHS Certificate of
 Compliance, [click here](#)

Please visit the [Contact Us](#) section for any
 non-product compliance questions.

Search Parts in this Series

[70247Series](#)

Mates With

[70450 SL™](#) Crimp Housing, [70058 SL™](#)
 Crimp Terminal

Termination Interface: Style Through Hole

Electrical

Current - Maximum per Contact 2.5A
Voltage - Maximum 250V DC

Solder Process Data

Duration at Max. Process Temperature (seconds) 10
Lead-free Process Capability Wave Capable (TH only)
Max. Cycles at Max. Process Temperature 1
Process Temperature max. C 265

Material Info

Reference - Drawing Numbers

Packaging Specification PK-87835-001
Product Specification PS-70246, PS-70246-100
Sales Drawing SDA-70247-**00-04

This document was generated on 05/24/2010

PLEASE CHECK WWW.MOLEX.COM FOR LATEST PART INFORMATION

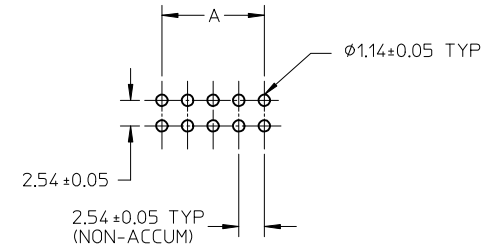
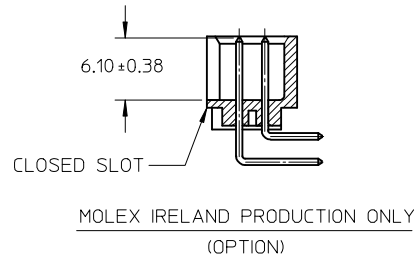
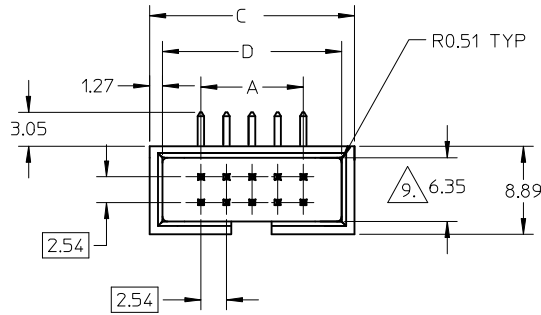

RECOMMENDED PCB HOLE LAYOUT

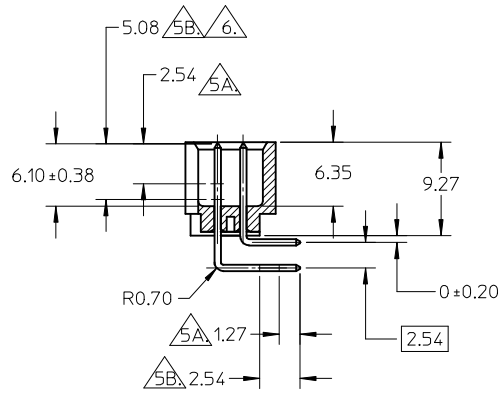
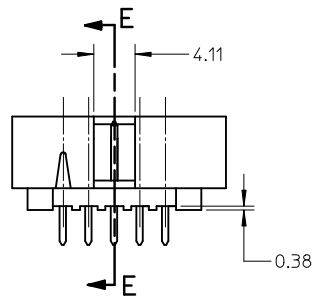

SECTION E-E

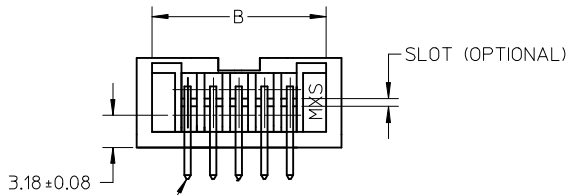

AT TIPS BOTH ENDS

LEGEND:



70247 - * * * *
 CKT SIZE
 PLATING OPT.



REVISE DIMENSIONS EC NO: S2010-0369 DRWN:SKANG 2009/10/27 CHKD:ATSEE 2009/11/09 APPR:MLONG 2009/11/11	QUALITY SYMBOLS $F_A=0$ $F_C=0$ $F_P=0$	GENERAL TOLERANCES (UNLESS SPECIFIED)		DIMENSION STYLE MM ONLY		SCALE NTS	DESIGN UNITS METRIC	THIRD ANGLE PROJECTION		
			mm	INCH	DRAWN BY	DATE	TITLE			
		4 PLACES	± ---	± ---	JENNIFER	1987/09/21	C-GRID, SHROUDED HEADER R/A (SLOTTED W/O STANDOFFS)			
		3 PLACES	± ---	± ---	CHECKED BY	DATE	MOLEX INCORPORATED			
	± 0.20	± ---	MLA1	1987/09/21	MATERIAL NO. SDA-70247-**-00-04					
	± ---	± ---	APPROVED BY	DATE	SHEET NO. 1 OF 2					
	ANGULAR ± 3 °		MLONG	2009/11/10	THIS DRAWING CONTAINS INFORMATION THAT IS PROPRIETARY TO MOLEX INCORPORATED AND SHOULD NOT BE USED WITHOUT WRITTEN PERMISSION					
	DRAFT WHERE APPLICABLE MUST REMAIN WITHIN DIMENSIONS		SIZE	SEE TABLE						
H3	REV									

NOTES:





1. PIN PUSHOUT FORCE (.9072KG)/2LBS MIN.
2. PIN SOLDERABILITY PER MOLEX SPEC. ES-152.
3. PRODUCT SPEC: PS-70246 APPLIES.
4. WAFER TO BE FLAT WITHIN .003 MM/MM.
5. DIMENSIONS FOR PLATING LOCATION:

 MEASURE POINT FOR THICKNESS
 MINIMUM COVERAGE

-  GOLD END OF PIN UNLESS OVERALL PLATED.
-  FINISH: - 51 : 15 MICRO INCHES MIN GOLD PLATE ON CONTACT AND 75 MICRO INCHES MIN TIN PLATE ON SOLDERTAIL BOTH OVER 50 MICRO INCHES MIN NICKEL OVERALL.
 - 52 : 30 MICRO INCHES MIN GOLD PLATE ON CONTACT AND 75 MICRO INCHES MIN TIN PLATE ON SOLDERTAIL BOTH OVER 50 MICRO INCHES MIN NICKEL OVERALL.
 - 54 : 5 MICRO INCHES MIN GOLD PLATE ON CONTACT AND 75 MICRO INCHES MIN TIN PLATE ON SOLDERTAIL BOTH OVER 50 MICRO INCHES MIN NICKEL OVERALL.

-  CHECK WITH SALES OFFICE FOR AVAILABILITY.
-  DIM AT THE CENTRE OF THE SHROUDED WALL SHALL BE 5.91MM MIN. THIS SPEC IS VALID FOR ALL CKT SIZE.
10. MATERIAL:
 HSG: PBT, GLASS FILLED, UL94V-0, COLOUR: BLACK (SPEC NO: 89992-0028)
 PIN: 0.64MM SQ. PIN PHOSPHOR BRONZE.
-  SOLDERTAIL POSITION TOLERANCE TO BE GAUGED.

PART NUMBER 	CKT SIZE	DIM A	DIM B	DIM C	DIM D
70247-08**	08	7.62	14.73	17.78	15.24
70247-10**	10	10.16	17.27	20.32	17.78
70247-12**	12	12.70	19.81	22.86	20.32
70247-14**	14	15.24	22.35	25.40	22.86
70247-16**	16	17.78	24.89	27.94	25.40
70247-20**	20	22.86	29.97	33.02	30.48
70247-24**	24	27.94	35.05	38.10	35.56
70247-26**	26	30.48	37.59	40.64	38.10
70247-30**	30	35.56	42.67	45.72	43.18
70247-34**	34	40.64	47.75	50.80	48.26
70247-40**	40	48.26	55.37	58.42	55.88
70247-44**	44	53.34	60.45	63.50	60.96
70247-48**	48	58.42	65.53	68.58	66.04
70247-50**	50	60.96	68.07	71.12	68.58
70247-56**	56	68.58	75.69	78.74	76.20
70247-60**	60	73.66	80.77	83.82	81.28
70247-64**	64	78.74	85.85	88.90	86.36
70247-72**	72	88.90	96.01	99.06	96.52

REVISE DIMENSIONS EC NO: S2010-0369 2009/10/27 DRWN:SKANG CHYKD:ATSEE 2009/11/09 APPR:MLONG 2009/11/11	QUALITY SYMBOLS	GENERAL TOLERANCES (UNLESS SPECIFIED)		DIMENSION STYLE MM ONLY		SCALE NTS	DESIGN UNITS METRIC	THIRD ANGLE PROJECTION		
	 =0	4 PLACES	mm	INCH	DRAWN BY JENNIFER	DATE 1987/09/21	TITLE C-GRID, SHROUDED HEADER R/A (SLOTTED W/O STANDOFFS)			
	 =0	3 PLACES	± ---	± ---	CHECKED BY MLA1	DATE 1987/09/21				
	 =0	2 PLACES	± 0.20	± ---	APPROVED BY MLONG	DATE 2009/11/10	 MOLEX INCORPORATED MATERIAL NO. SEE TABLE DOCUMENT NO. SDA-70247-**-00-04 SHEET NO. 2 OF 2			
	1 PLACE	± ---	± ---	DRAFT WHERE APPLICABLE MUST REMAIN WITHIN DIMENSIONS		THIS DRAWING CONTAINS INFORMATION THAT IS PROPRIETARY TO MOLEX INCORPORATED AND SHOULD NOT BE USED WITHOUT WRITTEN PERMISSION				