

Features

- 60V/62A,
 $R_{DS(ON)} = 7m\ (tpy.) @ V_{GS} = 10V$
- Super High Dense Cell Design
- Reliable and Rugged
- 100% avalanche tested
- Lead Free and Green Devices Available
 (RoHS Compliant)

Applications

- Power Management.

Pin Description

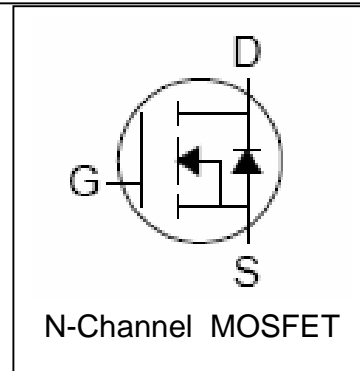
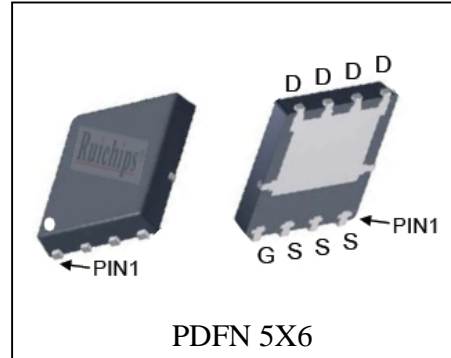

Absolute Maximum Ratings

Symbol	Parameter	Rating	Unit
Common Ratings ($T_C = 25^\circ C$ Unless Otherwise Noted)			
V_{DSS}	Drain-Source Voltage	60	V
V_{GSS}	Gate-Source Voltage	± 25	
T_J	Maximum Junction Temperature	150	$^\circ C$
T_{STG}	Storage Temperature Range	-55 to 150	$^\circ C$
I_S	Diode Continuous Forward Current	$T_C = 25^\circ C$ 50 ^①	A
Mounted on Large Heat Sink			
I_{DP}	300 μs Pulse Drain Current Tested	$T_C = 25^\circ C$ 240 ^②	A
I_D	Continuous Drain Current ($V_{GS} = 10V$)	$T_C = 25^\circ C$ 62 ^①	A
		$T_C = 100^\circ C$ 40	
		$T_A = 25^\circ C$ 16 ^③	
		$T_A = 70^\circ C$ 13 ^③	
P_D	Maximum Power Dissipation	$T_C = 25^\circ C$ 62.5	W
		$T_C = 100^\circ C$ 25	
		$T_A = 25^\circ C$ 4.2 ^③	
		$T_A = 70^\circ C$ 2.7 ^③	

Mounted on Large Heat Sink			
$R_{\theta JC}$	Thermal Resistance-Junction to Case	2	°C/W
$R_{\theta JA}^{(3)}$	Thermal Resistance-Junction to Ambient	30	°C/W
Drain-Source Avalanche Ratings			
$E_{AS}^{(4)}$	Avalanche Energy, Single Pulsed	225	mJ

Electrical Characteristics ($T_C=25^\circ\text{C}$ Unless Otherwise Noted)

Symbol	Parameter	Test Condition	RU6888M			Unit
			Min.	Typ.	Max.	
Static Characteristics						
BV_{DSS}	Drain-Source Breakdown Voltage	$V_{GS}=0V, I_{DS}=250\mu A$	60			V
I_{DSS}	Zero Gate Voltage Drain Current	$V_{DS}=60V, V_{GS}=0V$ $T_J=85^\circ\text{C}$			1 30	μA
$V_{GS(th)}$	Gate Threshold Voltage	$V_{DS}=V_{GS}, I_{DS}=250\mu A$	2	3	4	V
I_{GSS}	Gate Leakage Current	$V_{GS}=\pm 25V, V_{DS}=0V$			± 100	nA
$R_{DS(ON)}^{(5)}$	Drain-Source On-state Resistance	$V_{GS}=10V, I_{DS}=40A$		7	8	m Ω
Diode Characteristics						
$V_{SD}^{(5)}$	Diode Forward Voltage	$I_{SD}=40A, V_{GS}=0V$			1.2	V
t_{rr}	Reverse Recovery Time	$I_{SD}=20A, di_{SD}/dt=100A/\mu s$		32		ns
Q_{rr}	Reverse Recovery Charge			40		nC
Dynamic Characteristics ⁽⁶⁾						
R_G	Gate Resistance	$V_{GS}=0V, V_{DS}=0V, F=1\text{MHz}$		1.4		Ω
C_{iss}	Input Capacitance	$V_{GS}=0V,$ $V_{DS}=30V,$ Frequency=1.0MHz		3450		pF
C_{oss}	Output Capacitance			310		
C_{riss}	Reverse Transfer Capacitance			110		
$t_{d(ON)}$	Turn-on Delay Time	$V_{DD}=30V, R_L=1.5\Omega,$ $I_{DS}=20A, V_{GEN}=10V,$ $R_G=3\Omega$		27		ns
t_r	Turn-on Rise Time			32		
$t_{d(OFF)}$	Turn-off Delay Time			97		
t_f	Turn-off Fall Time			67		
Gate Charge Characteristics ⁽⁶⁾						
Q_g	Total Gate Charge	$V_{DS}=48V, V_{GS}=10V,$ $I_{DS}=20A$		75		nC
Q_{gs}	Gate-Source Charge			18		
Q_{gd}	Gate-Drain Charge			23		

- Notes: ① Current is limited to 50A by source bonding technology.
② Pulse width limited by safe operating area.
③ When mounted on 1 inch square copper board, $t \leq 10\text{sec}$.
④ Limited by $T_{J\text{max}}$, $I_{AS} = 30\text{A}$, $V_{DD} = 48\text{V}$, $R_G = 50\Omega$, Starting $T_J = 25^\circ\text{C}$.
⑤ Pulse test ; Pulse width $\leq 300\mu\text{s}$, duty cycle $\leq 2\%$.
⑥ Guaranteed by design, not subject to production testing.

Ordering and Marking Information

Device	Marking	Package	Packaging	Quantity	Reel Size	Tape width
RU6888M	RU6888M	PDFN 5X6	Tape&Reel	3000	13''	12mm

Typical Characteristics

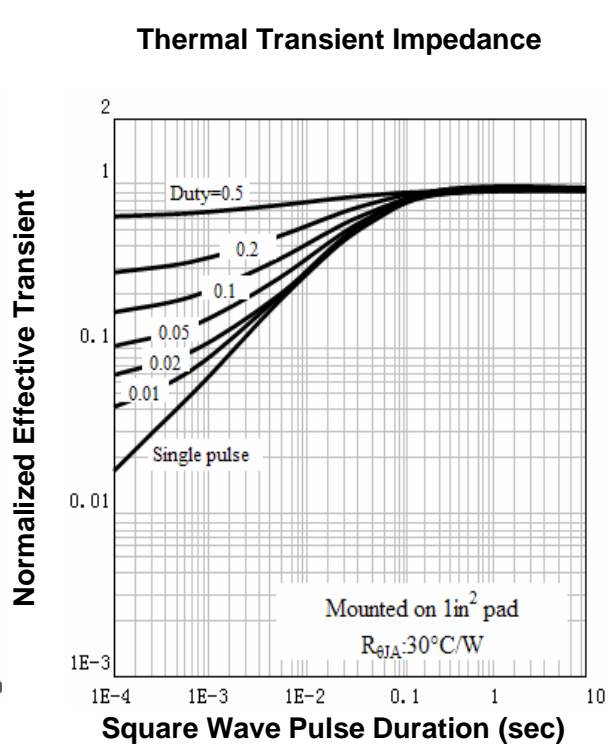
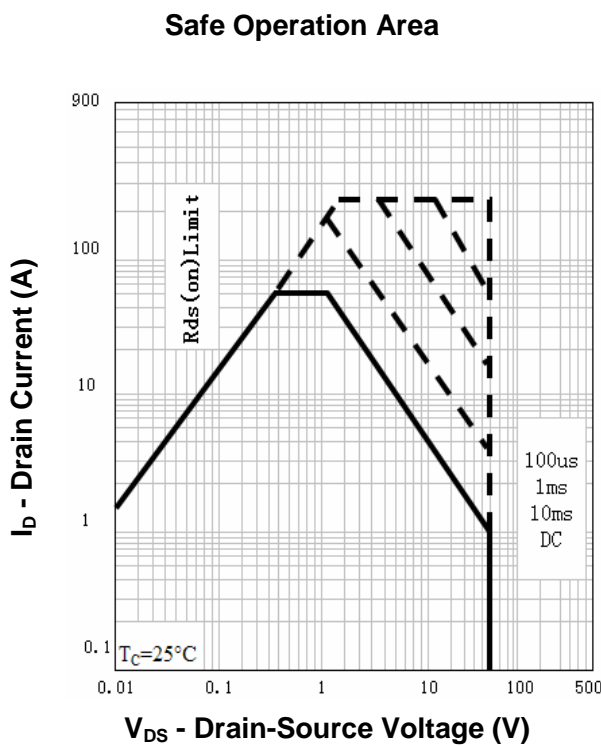
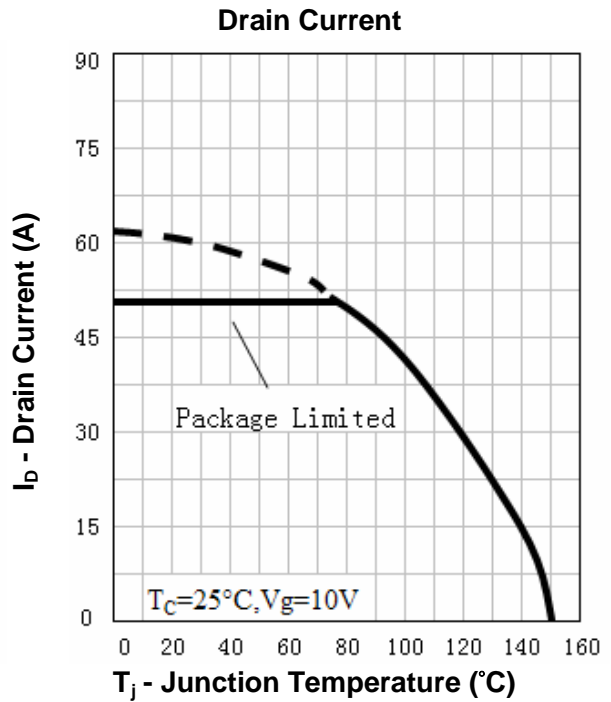
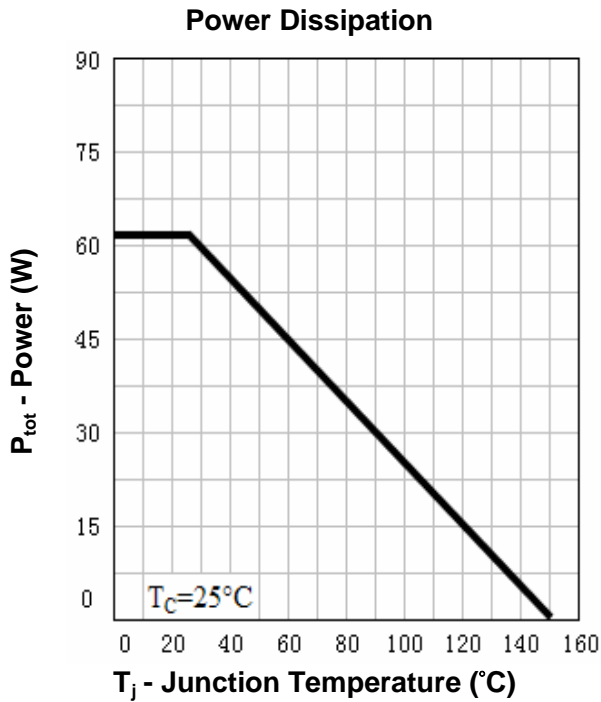

Typical Characteristics

Output Characteristics

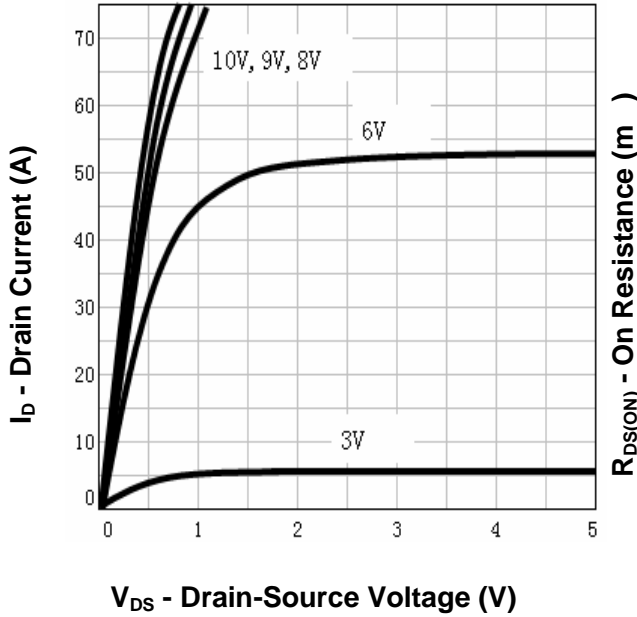

Drain-Source On Resistance

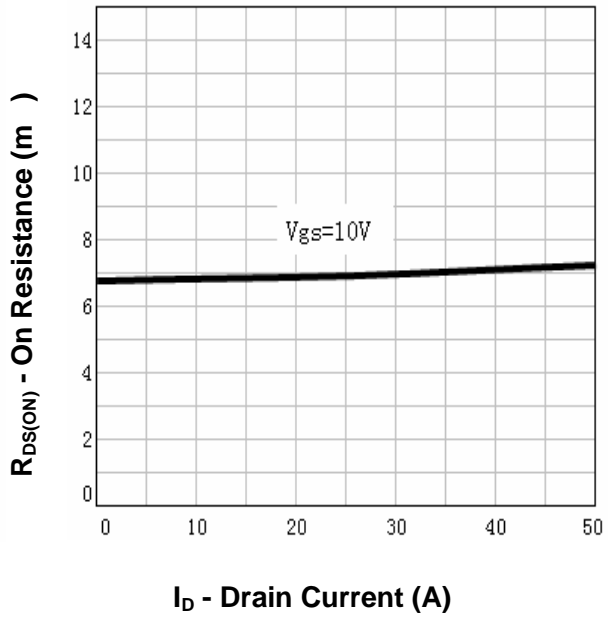

Drain-Source On Resistance

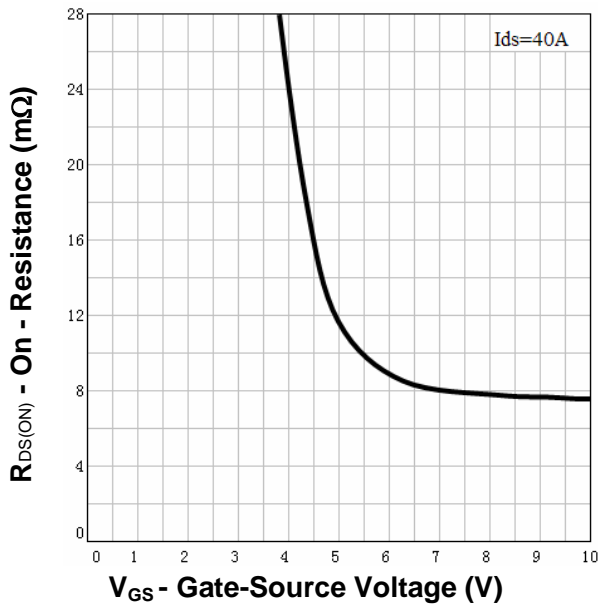

Gate Threshold Voltage

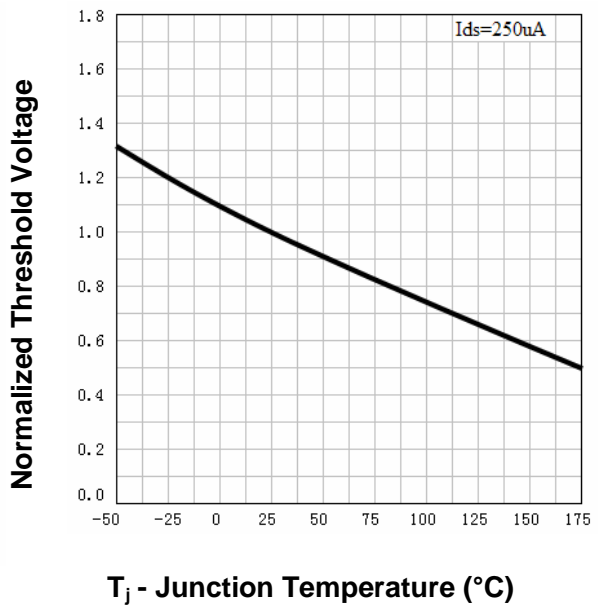

Typical Characteristics

Drain-Source On Resistance

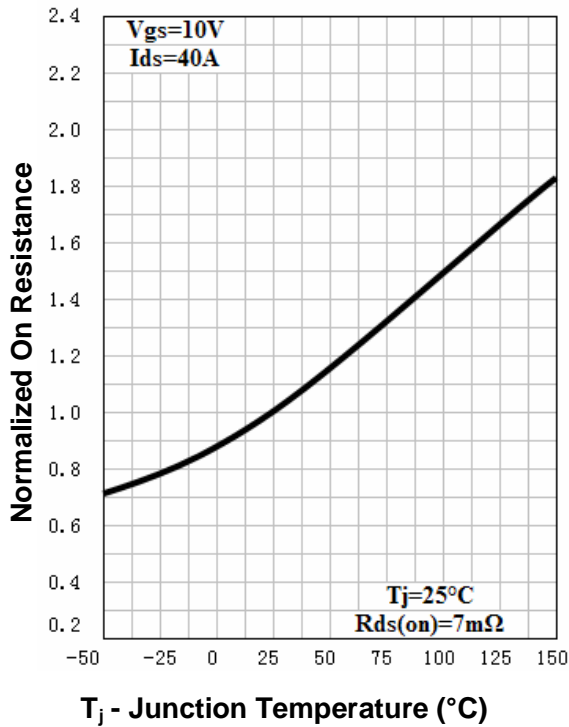

Source-Drain Diode Forward

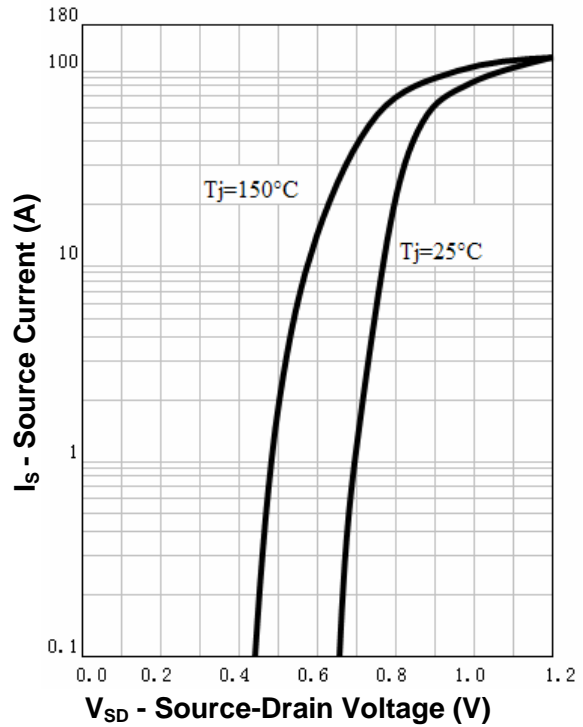

Capacitance

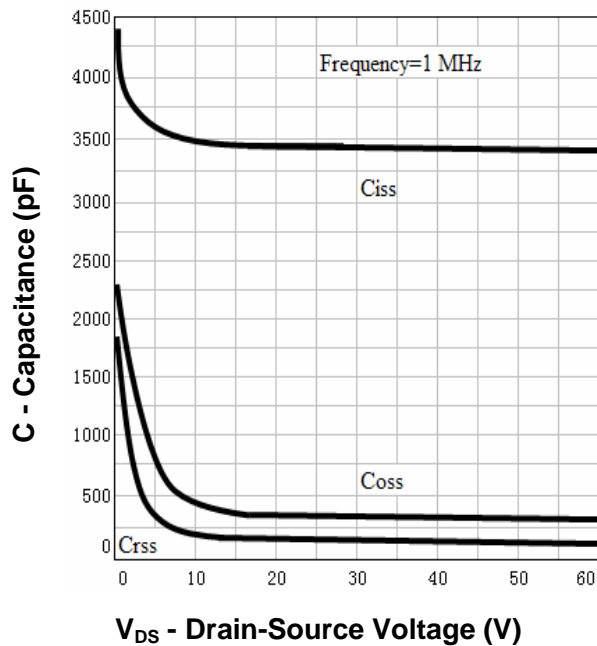

Gate Charge

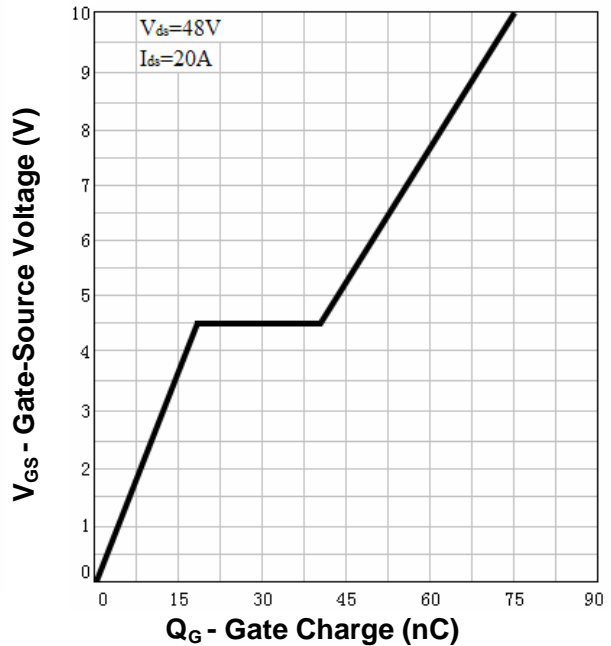

Avalanche Test Circuit and Waveforms

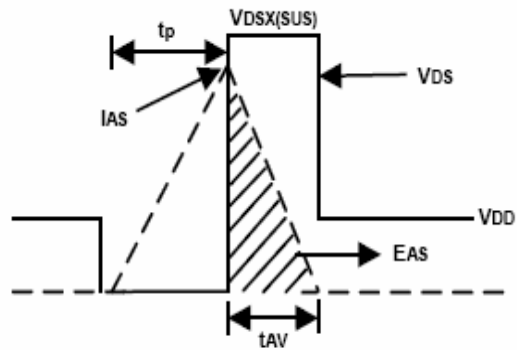
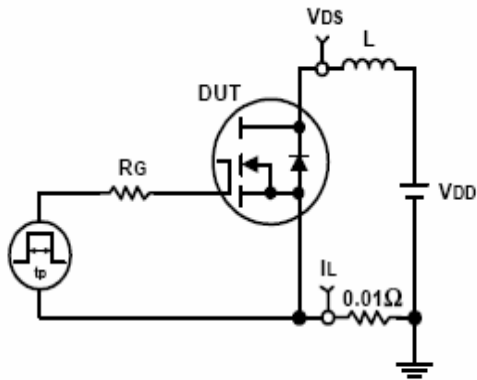

Switching Time Test Circuit and Waveforms

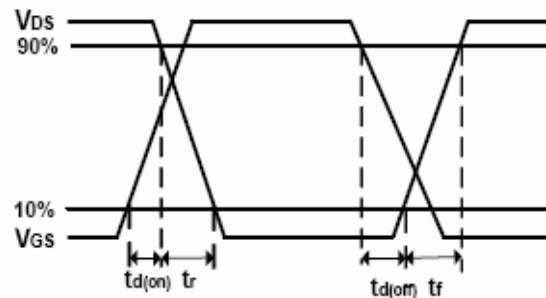
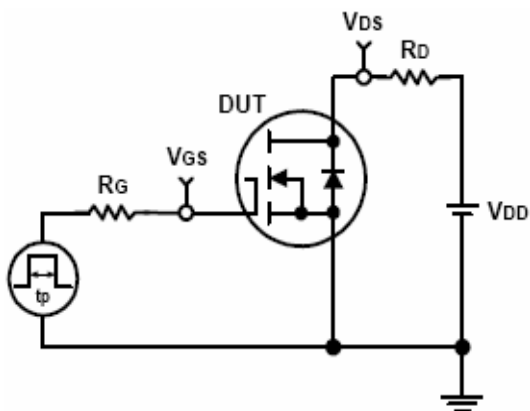

Package Information

PDFN 5X6

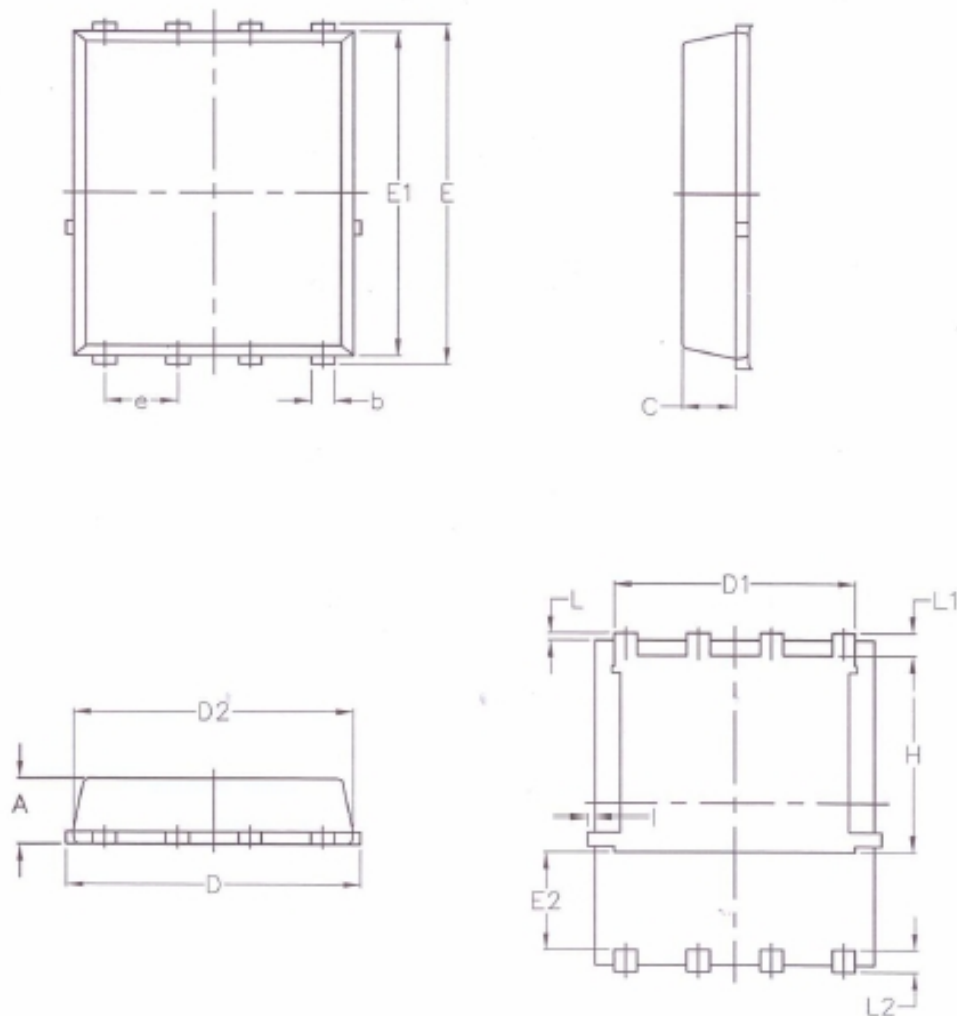

SYMBOL	MM		INCH		SYMBOL	MM		INCH	
	MIN	MAX	MIN	MAX		MIN	MAX	MIN	MAX
A	1.030	1.170	0.040	0.046	E2	1.600	-	0.063	-
b	0.340	0.480	0.013	0.019	e	1.270 BSC		0.050 BSC	
C	0.824	0.970	0.032	0.038	L	0.050	0.250	0.002	0.010
D	4.800	5.400	0.189	0.213	L1	0.380	0.500	0.015	0.020
D1	4.110	4.310	0.162	0.170	L2	0.380	0.500	0.015	0.020
D2	4.800	5.000	0.189	0.197	H	3.500	3.700	0.138	0.146
E	5.950	6.150	0.234	0.242	I	-	0.180	-	0.007
E1	5.650	5.850	0.222	0.230					

ALL DIMENSIONS REFER TO JEDEC STANDARD
DO NOT INCLUDE MOLD FLASH OR PROTRUSIONS

Customer Service

Worldwide Sales and Service:

Sales@ruichips.com

Technical Support:

Technical@ruichips.com

Investor Relations Contacts:

Investor@ruichips.com

Marcom Contact:

Marcom@ruichips.com

Editorial Contact:

Editorial@ruichips.com

HR Contact:

HR@ruichips.com

Legal Contact:

Legal@ruichips.com

Shen Zhen RUICHIPS Semiconductor CO., LTD

Room 501, the 5floor An Tong Industrial Building,
NO.207 Mei Hua Road Fu Tian Area Shen Zhen City, CHINA

TEL: (86-755) 8311-5334

FAX: (86-755) 8311-4278

E-mail: Sales-SZ@ruichips.com