



GaAs MMIC DOUBLE-BALANCED HIGH IP3 MIXER, 6 - 12 GHz

Typical Applications

The HMC663LC3 is ideal for:

- Point-to-Point Radios
- Point-to-Multi-Point Radios
- Test Equipment & Sensors
- Military End-Use

Features

- High LO/RF Isolation: 40 dB
- Wide IF Bandwidth: DC - 4 GHz
- Passive Double-Balanced Topology
- Low Conversion Loss: 8 dB
- 16 Lead Ceramic 3x3mm SMT Package: 9mm²

Functional Diagram

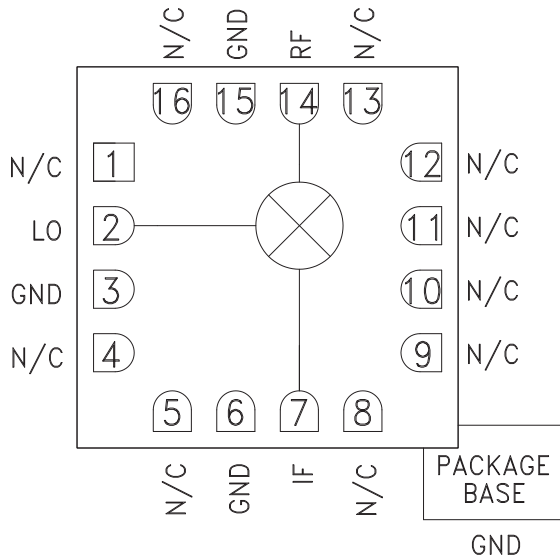

General Description

The HMC663LC3 is a general purpose double balanced mixer in a leadless RoHS compliant ceramic SMT package that can be used as an upconverter or downconverter between 6 and 12 GHz. This passive mixer is fabricated in a GaAs MESFET process, requires no DC Bias and no external components or matching circuitry.

The HMC663LC3 provides excellent LO to RF and LO to IF isolation due to optimized balun structures and operates with LO drive levels as low as +17 dBm. The HMC663LC3 eliminates the need for wire bonding, and is compatible with high volume surface mount manufacturing techniques.

Electrical Specifications, $T_A = +25^\circ\text{C}$, $IF = 100\text{ MHz}$, $LO = +21\text{ dBm}^*$

Parameter	Min.	Typ.	Max.	Units
Frequency Range, RF		6 to 12		GHz
Frequency Range, LO		6 to 14		GHz
Frequency Range, IF		DC to 4		GHz
Conversion Loss		8	12	dB
Noise Figure (SSB)		10		dB
LO to RF Isolation	29	40		dB
LO to IF Isolation	27	42		dB
RF to IF Isolation	8	20		dB
IP3 (Input)		30		dBm
IP2 (Input)		55		dBm
1 dB Gain Compression (Input)		20		dBm

*Unless otherwise noted, all measurements performed as downconverter, with high side LO and with IF = 100 MHz.

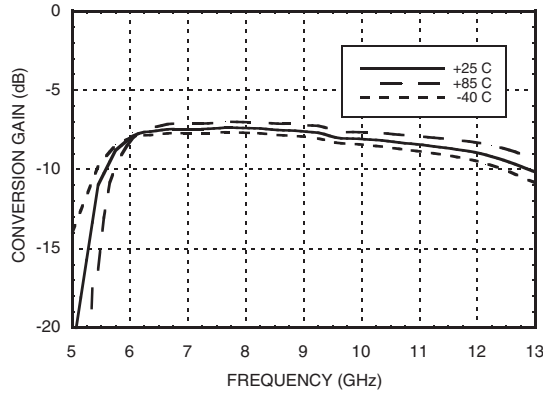
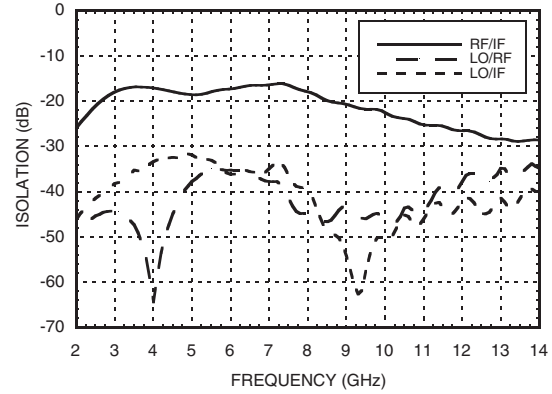
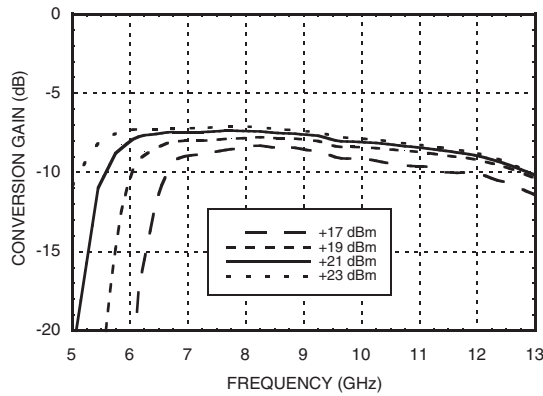
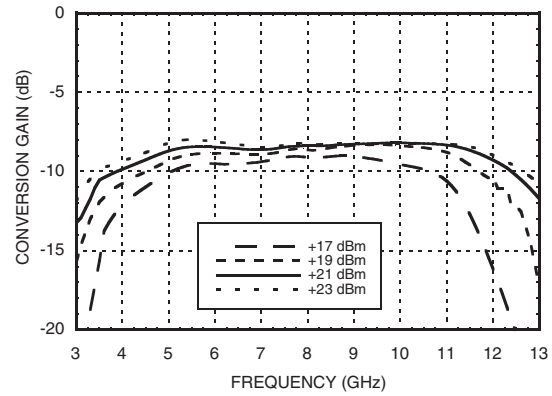
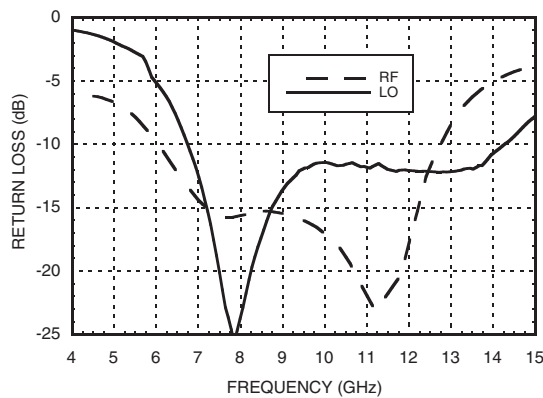
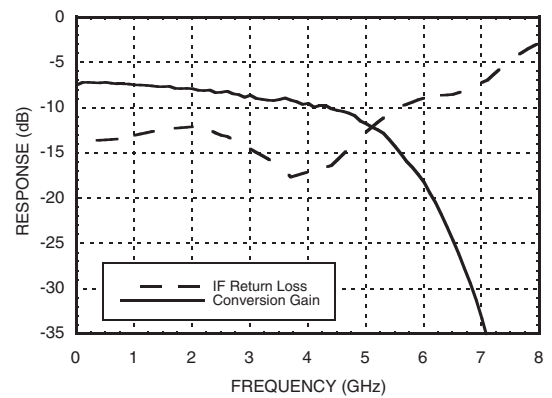
**GaAs MMIC DOUBLE-BALANCED
HIGH IP3 MIXER, 6 - 12 GHz**
Conversion Gain vs. Temperature

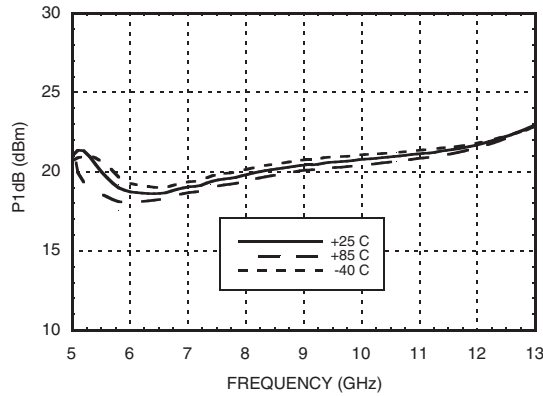
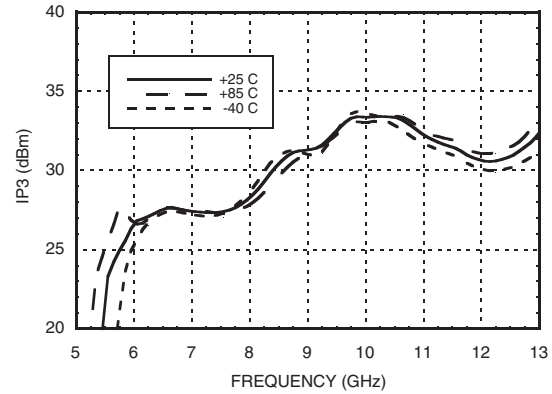
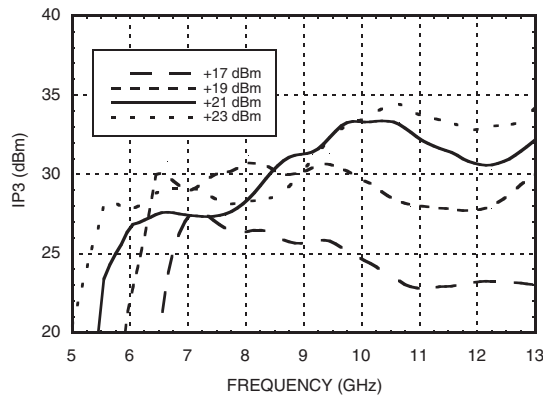
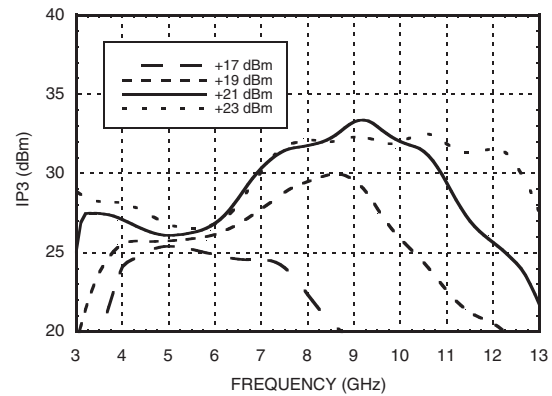
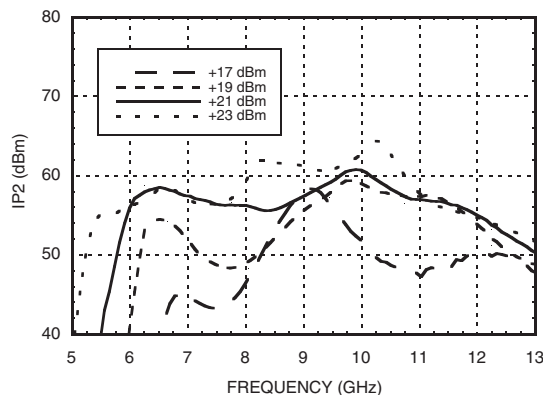
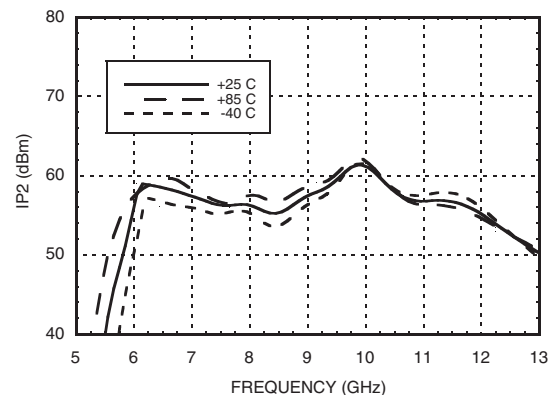
Isolation

**Conversion Gain vs.
LO Drive, IF= 100 MHz**

**Conversion Gain vs.
LO Drive, IF= 3000 MHz**

Return Loss

IF Bandwidth

**GaAs MMIC DOUBLE-BALANCED
HIGH IP3 MIXER, 6 - 12 GHz**
Input P1dB vs. Temperature *

Input IP3 vs. Temperature *

Input IP3 vs. LO Drive, IF = 100 MHz *

Input IP3 vs. LO Drive, IF = 3000 MHz *

Input IP2 vs. LO Drive *

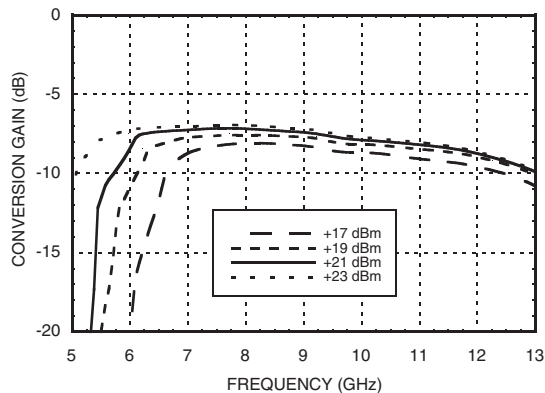
Input IP2 vs. Temperature *

* Two-tone input power = -5 dBm each tone, 1 MHz spacing.



GaAs MMIC DOUBLE-BALANCED HIGH IP3 MIXER, 6 - 12 GHz

Upconverter Performance Conversion Gain vs. LO Drive



Absolute Maximum Ratings

RF / IF Input	+23 dBm
LO Drive	+23 dBm
Channel Temperature	150 °C
Continuous P _{diss} (T= 85 °C) (derate 17 mW/°C above 85 °C)	1.08 W
Thermal Resistance (channel to ground paddle)	60 °C/W
Storage Temperature	-65 to +150 °C
Operating Temperature	-40 to +85 °C

10



ELECTROSTATIC SENSITIVE DEVICE
OBSERVE HANDLING PRECAUTIONS

Harmonics of LO

LO Freq. (GHz)	nLO Spur at RF Port			
	1	2	3	4
4	59	60	66	81
5	40	48	69	92
6	35	42	68	83
7	37	39	80	74
8	46	48	71	70
9	45	64	70	106
10	46	70	70	69
11	44	63	60	66
12	40	59	64	xx
13	38	58	62	xx
14	35	59	64	xx
15	34	60	xx	xx

LO = +21 dBm
Values in dBc below input LO level measured at RF port.

MxN Spurious Outputs

mRF	nLO				
	0	1	2	3	4
0	xx	22	31	50	48
1	14	0	34	60	71
2	90	77	77	77	111
3	116	121	90	78	89
4	114	119	124	117	113

RF = 9.0 GHz @ -5 dBm
LO = 9.1 GHz @ +21 dBm
All values in dBc below the IF output power level (-1 RF +1 LO).

MIXERS - SINGLE & DOUBLE BALANCED - SMT

Outline Drawing

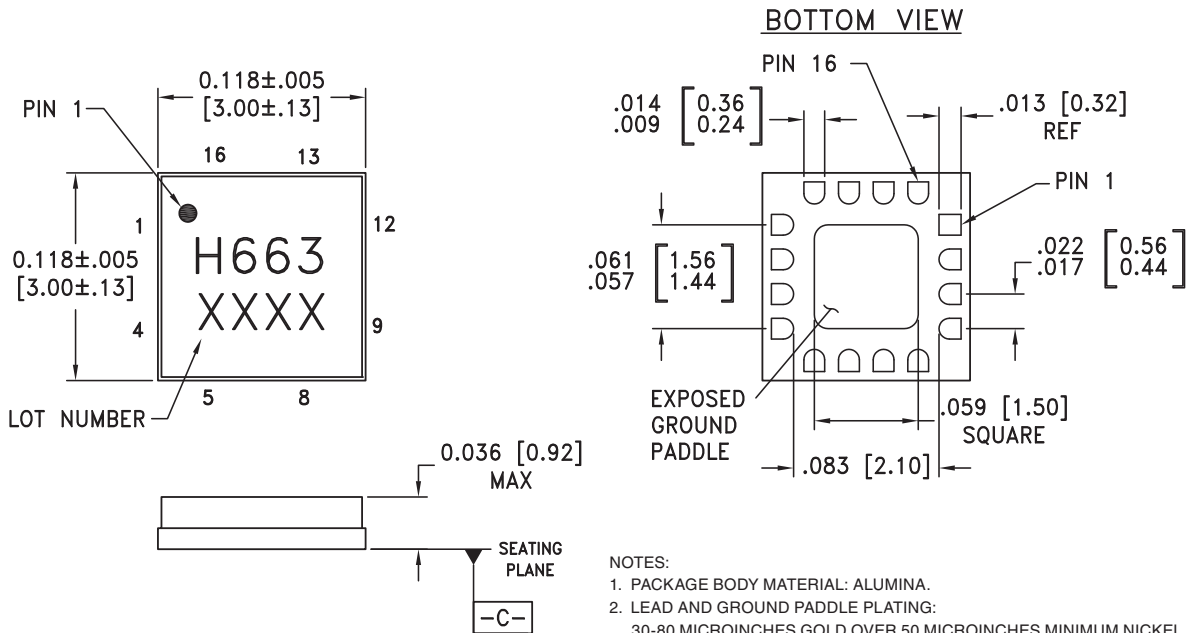

Pin Descriptions

Pin Number	Function	Description	Interface Schematic
1, 4, 5, 8 - 13, 16	N/C	Not Connected	
2	LO	This pin is AC coupled and matched to 50 Ohms.	LO ○ — —
3, 6, 15	GND	These pins and package base must be connected to RF/DC ground.	○ GND ⏏
7	IF	This pad is DC coupled. For applications not requiring operation to DC, this port should be DC blocked externally using a series capacitor whose value has been chosen to pass the necessary IF frequency range. For operation to DC, this pin must not source or sink more than 2 mA of current or part non-function and possible part failure will result.	IF ○ — — ⏏
14	RF	This pin is AC coupled and matched to 50 Ohms.	— — ○ RFOUT

Evaluation PCB

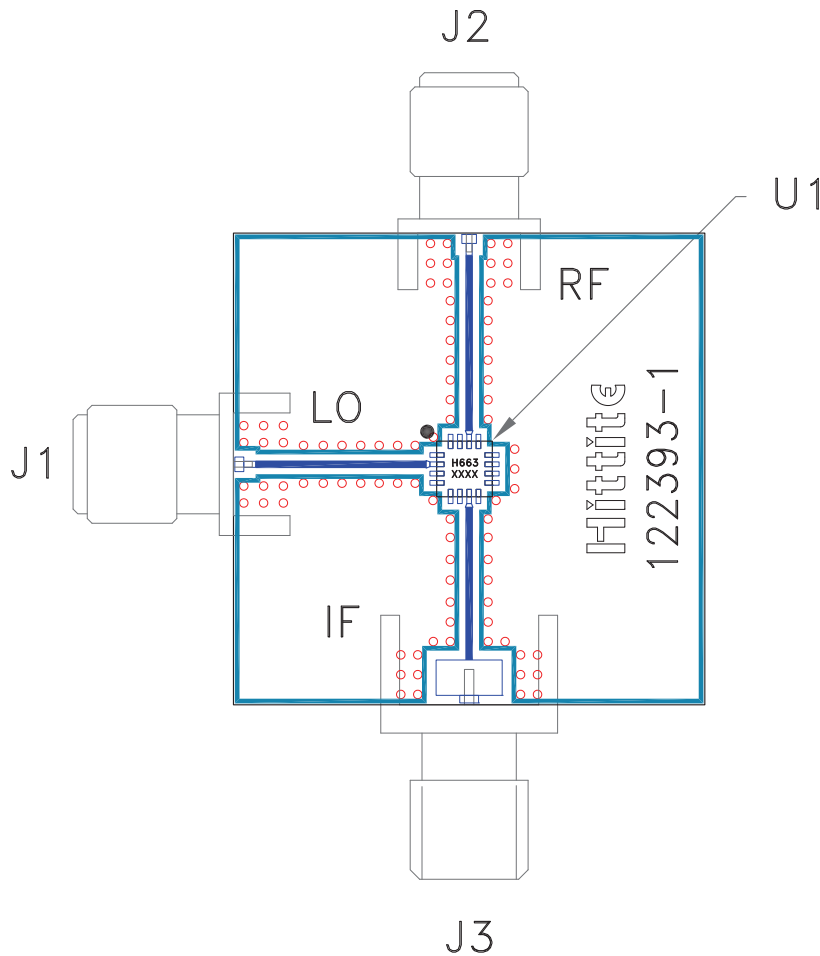

List of Materials for Evaluation PCB 122395 [1]

Item	Description
J1, J2	PCB Mount SMA SRI Connector
J3	PCB Mount SMA Connector
U1	HMC663LC3 Mixer
PCB [2]	122393 Evaluation PCB

[1] Reference this number when ordering complete evaluation PCB

[2] Circuit Board Material: Rogers 4350 or Arlon 25 FR, FR4

The circuit board used in this application should use RF circuit design techniques. Signal lines should have 50 Ohm impedance while the package ground leads and exposed paddle should be connected directly to the ground plane similar to that shown. A sufficient number of via holes should be used to connect the top and bottom ground planes. The evaluation circuit board shown is available from Hittite upon request.