

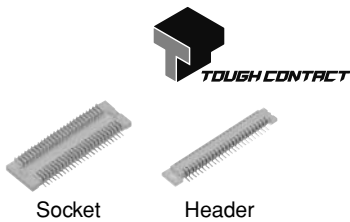

## NARROW-PITCH CONNECTORS FOR BOARD-TO-BOARD CONNECTION

# NARROW PITCH (0.5mm) CONNECTORS P5 SERIES — P5KF —

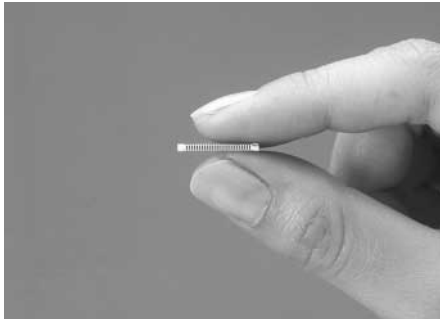

3) Use of Ni barrier construction is standard. Highly effective against solder creeping. (Available from Oct. 2005)

**● What is Ni barrier construction?**  
By providing an exposed nickel part on the gold (Au) plated contact, solder creeping is prevented despite the ultra low profile.

**[Contact]**

4) Porosity treatment applied for improved resistance against corrosion.

**What is porosity treatment?**  
This treatment consists of coating the surface with a very thin film to seal pinholes in the gold plating. This porosity treatment technology ensures the same contact reliability for thin gold plating as that of thick gold plating.

- Improvement in insertion/removal durability
- Improvement in resistance to corrosion
- Improvement in contact reliability for digital signals

**3. Simple locking structure**  
Superior mating operation with click feel to indicate that mating is complete.

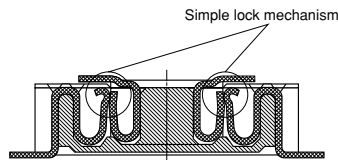

**4. Mating length 0.55mm**  
While achieving a low profile of 1.5mm between PCBs, the effective mating length has been extended to ensure that there is some latitude in the mating.

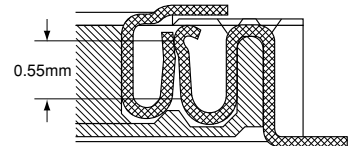

**5. The lower connector bottom surface construction prevents contact and shorts between the PCB and metal terminals.**  
This enables freedom in pattern wiring, helping to make PCB's smaller.

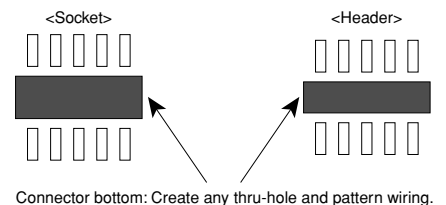

- 6. Automatic mounting inspection is facilitated by the gull-wing terminal shape which makes mounting verification easy.**
- 7. Compliance with RoHS' Directive**  
Environmentally friendly, the connectors' comply with Europe's RoHS' Directive. Cadmium, lead, mercury, hexavalent, chromium, PBB and PBDE are not used.
- 8. Connectors for inspection available**  
Connectors for inspection are available that are ideal for modular unit inspection and inspection in device assembly processes.

## FEATURES

- 1. The connector is a two-piece structure and 0.5mm pitch.**  
The product lineup consists of the mated height of 1.5mm, 2.0mm and 2.5mm.
- 2. Strong resistance to adverse environments! Utilizes TOUGH CONTACT construction for high contact reliability.**  
1) The socket and header has the same dropping shock and torsion resistant construction as the bellows-type contact.

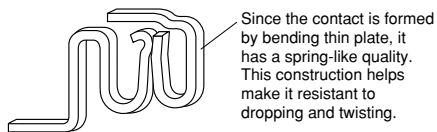

2) V notch construction used for excellent resistance against foreign matters.

**● What is V notch construction?**  
By using the edge for the contacting part and increasing contact pressure per unit area, the effectiveness in removing flux and contaminants is increased compared to its predecessor. This is also effective in preventing the trapping of contaminants.

**[Cross section of contacting part]**

## APPLICATIONS

- Cellular phones
- PHS
- Portable data terminals
- Digital cameras
- Compact portable devices

### Ideal for Board-to-FPC connections

The simple lock mechanism ensures that the connector clicks into position when it is inserted for reliable single-action insertion on the PCB.

This enables the number of pins to be doubled while the size remains the same as that for existing FPC connectors. This, in turn, contributes to making products and equipment more compact.

# AXK(5/6)F

## TABLE OF PRODUCT TYPES



Socket



Header

Product name		P5KF		
Mated height				
	1.5mm	2.0mm	2.5mm	
Number of contacts	10	☆	☆	☆
	12	☆	☆	☆
	14	☆	☆	☆
	16	☆	☆	☆
	18	☆	☆	☆
	20	☆	☆	☆
	22	☆	☆	☆
	24	☆	☆	☆
	26	☆	☆	
	30	☆	☆	☆
	32	☆		
	34	☆	☆	☆
	36			☆
	40	☆	☆	☆
	44			☆
	50	☆	☆	☆
	60	☆	☆	☆
70	☆	☆	☆	
80	☆	☆	☆	
100		☆	☆	

- Notes: 1. The standard type comes without positioning bosses.  
Connectors with positioning boss are available for on-demand production.  
2. Please consult us for products which have no ☆ mark.

## ORDERING INFORMATION

AXK

5F: Narrow Pitch Connector P5KF (0.5 mm pitch) Socket  
6F: Narrow Pitch Connector P5KF (0.5 mm pitch) Header

Number of contacts (2 digits)

Mated height

<Socket>

- 3: For mated height 1.5 mm
- 5: For mated height 2.0 mm and 2.5 mm

<Header>

- 3: For mated height 1.5 mm and 2.0 mm
- 5: For mated height 2.5 mm

Functions

- 3: With positioning bosses
- 4: Without positioning bosses

Surface treatment (Contact portion / Terminal portion)

<Socket>

- 5: Ni plating on base, Au plating on surface/Ni plating on base, Au plating on surface
- 7: Ni plating on base, Au plating on surface/Ni plating on base, Au plating on surface  
(for Ni barrier product available from Oct. 2005)

Contact portion

<Socket>

Y: V notch type product (chamfered on both sides)

<Header>

Y: V notch type product

Packing

- G: 2,000 pieces embossed tape and plastic reel × 2 (from Oct. 2005)
- J: 2,000 pieces embossed tape and paper reel × 2

## PRODUCT TYPES

Mated height	No. of contacts	Part No.				Packing	
		Socket		Header		Inner carton (1-reel)	Outer carton
		Ni barrier product: Not available (Paper reel)	<b>TOUGH CONTACT</b> (Plastic reel) (Recommendation)	Ni barrier product: Not available (Paper reel)	<b>TOUGH CONTACT</b> (Plastic reel) (Recommendation)		
1.5 mm	10	AXK5F10345YJ	AXK5F10347YG (From Oct. 2005)	AXK6F10345YJ	AXK6F10347YG (From Oct. 2005)	2,000 pieces	4,000 pieces
	12	AXK5F12345YJ	AXK5F12347YG (From Oct. 2005)	AXK6F12345YJ	AXK6F12347YG (From Oct. 2005)		
	14	AXK5F14345YJ	AXK5F14347YG (From Oct. 2005)	AXK6F14345YJ	AXK6F14347YG (From Oct. 2005)		
	16	AXK5F16345YJ	AXK5F16347YG (From Oct. 2005)	AXK6F16345YJ	AXK6F16347YG (From Oct. 2005)		
	18	AXK5F18345YJ	AXK5F18347YG (From Oct. 2005)	AXK6F18345YJ	AXK6F18347YG (From Oct. 2005)		
	20	AXK5F20345YJ	AXK5F20347YG (From Oct. 2005)	AXK6F20345YJ	AXK6F20347YG (From Oct. 2005)		
	22	AXK5F22345YJ	AXK5F22347YG (From Oct. 2005)	AXK6F22345YJ	AXK6F22347YG (From Oct. 2005)		
	24	AXK5F24345YJ	AXK5F24347YG (From Oct. 2005)	AXK6F24345YJ	AXK6F24347YG (From Oct. 2005)		
	26	AXK5F26345YJ	AXK5F26347YG (From Oct. 2005)	AXK6F26345YJ	AXK6F26347YG (From Oct. 2005)		
	30	AXK5F30345YJ	AXK5F30347YG (From Oct. 2005)	AXK6F30345YJ	AXK6F30347YG (From Oct. 2005)		
	32	AXK5F32345YJ	AXK5F32347YG (From Oct. 2005)	AXK6F32345YJ	AXK6F32347YG (From Oct. 2005)		
	34	AXK5F34345YJ	AXK5F34347YG (From Oct. 2005)	AXK6F34345YJ	AXK6F34347YG (From Oct. 2005)		
	40	AXK5F40345YJ	AXK5F40347YG (From Oct. 2005)	AXK6F40345YJ	AXK6F40347YG (From Oct. 2005)		
	50	AXK5F50345YJ	AXK5F50347YG (From Oct. 2005)	AXK6F50345YJ	AXK6F50347YG (From Oct. 2005)		
	60	AXK5F60345YJ	AXK5F60347YG (From Oct. 2005)	AXK6F60345YJ	AXK6F60347YG (From Oct. 2005)		
	70	AXK5F70345YJ	AXK5F70347YG (From Oct. 2005)	AXK6F70345YJ	AXK6F70347YG (From Oct. 2005)		
80	AXK5F80345YJ	AXK5F80347YG (From Oct. 2005)	AXK6F80345YJ	AXK6F80347YG (From Oct. 2005)			
2.0 mm	10	AXK5F10545YJ	AXK5F10547YG (From Oct. 2005)	AXK6F10345YJ	AXK6F10347YG (From Oct. 2005)	2,000 pieces	4,000 pieces
	12	AXK5F12545YJ	AXK5F12547YG (From Oct. 2005)	AXK6F12345YJ	AXK6F12347YG (From Oct. 2005)		
	14	AXK5F14545YJ	AXK5F14547YG (From Oct. 2005)	AXK6F14345YJ	AXK6F14347YG (From Oct. 2005)		
	16	AXK5F16545YJ	AXK5F16547YG (From Oct. 2005)	AXK6F16345YJ	AXK6F16347YG (From Oct. 2005)		
	18	AXK5F18545YJ	AXK5F18547YG (From Oct. 2005)	AXK6F18345YJ	AXK6F18347YG (From Oct. 2005)		
	20	AXK5F20545YJ	AXK5F20547YG (From Oct. 2005)	AXK6F20345YJ	AXK6F20347YG (From Oct. 2005)		
	22	AXK5F22545YJ	AXK5F22547YG (From Oct. 2005)	AXK6F22345YJ	AXK6F22347YG (From Oct. 2005)		
	24	AXK5F24545YJ	AXK5F24547YG (From Oct. 2005)	AXK6F24345YJ	AXK6F24347YG (From Oct. 2005)		
	26	AXK5F26545YJ	AXK5F26547YG (From Oct. 2005)	AXK6F26345YJ	AXK6F26347YG (From Oct. 2005)		
	30	AXK5F30545YJ	AXK5F30547YG (From Oct. 2005)	AXK6F30345YJ	AXK6F30347YG (From Oct. 2005)		
	34	AXK5F34545YJ	AXK5F34547YG (From Oct. 2005)	AXK6F34345YJ	AXK6F34347YG (From Oct. 2005)		
	40	AXK5F40545YJ	AXK5F40547YG (From Oct. 2005)	AXK6F40345YJ	AXK6F40347YG (From Oct. 2005)		
	50	AXK5F50545YJ	AXK5F50547YG (From Oct. 2005)	AXK6F50345YJ	AXK6F50347YG (From Oct. 2005)		
	60	AXK5F60545YJ	AXK5F60547YG (From Oct. 2005)	AXK6F60345YJ	AXK6F60347YG (From Oct. 2005)		
	70	AXK5F70545YJ	AXK5F70547YG (From Oct. 2005)	AXK6F70345YJ	AXK6F70347YG (From Oct. 2005)		
	80	AXK5F80545YJ	AXK5F80547YG (From Oct. 2005)	AXK6F80345YJ	AXK6F80347YG (From Oct. 2005)		
100	AXK5F00545YJ	AXK5F00547YG (From Oct. 2005)	AXK6F00345YJ	AXK6F00347YG (From Oct. 2005)			
2.5 mm	10	AXK5F10545YJ	AXK5F10547YG (From Oct. 2005)	AXK6F10545YJ	AXK6F10547YG (From Oct. 2005)	2,000 pieces	4,000 pieces
	12	AXK5F12545YJ	AXK5F12547YG (From Oct. 2005)	AXK6F12545YJ	AXK6F12547YG (From Oct. 2005)		
	14	AXK5F14545YJ	AXK5F14547YG (From Oct. 2005)	AXK6F14545YJ	AXK6F14547YG (From Oct. 2005)		
	16	AXK5F16545YJ	AXK5F16547YG (From Oct. 2005)	AXK6F16545YJ	AXK6F16547YG (From Oct. 2005)		
	20	AXK5F20545YJ	AXK5F20547YG (From Oct. 2005)	AXK6F20545YJ	AXK6F20547YG (From Oct. 2005)		
	22	AXK5F22545YJ	AXK5F22547YG (From Oct. 2005)	AXK6F22545YJ	AXK6F22547YG (From Oct. 2005)		
	24	AXK5F24545YJ	AXK5F24547YG (From Oct. 2005)	AXK6F24545YJ	AXK6F24547YG (From Oct. 2005)		
	30	AXK5F30545YJ	AXK5F30547YG (From Oct. 2005)	AXK6F30545YJ	AXK6F30547YG (From Oct. 2005)		
	34	AXK5F34545YJ	AXK5F34547YG (From Oct. 2005)	AXK6F34545YJ	AXK6F34547YG (From Oct. 2005)		
	36	AXK5F36545YJ	AXK5F36547YG (From Oct. 2005)	AXK6F36545YJ	AXK6F36547YG (From Oct. 2005)		
	40	AXK5F40545YJ	AXK5F40547YG (From Oct. 2005)	AXK6F40545YJ	AXK6F40547YG (From Oct. 2005)		
	44	AXK5F44545YJ	AXK5F44547YG (From Oct. 2005)	AXK6F44545YJ	AXK6F44547YG (From Oct. 2005)		
	50	AXK5F50545YJ	AXK5F50547YG (From Oct. 2005)	AXK6F50545YJ	AXK6F50547YG (From Oct. 2005)		
	60	AXK5F60545YJ	AXK5F60547YG (From Oct. 2005)	AXK6F60545YJ	AXK6F60547YG (From Oct. 2005)		
	70	AXK5F70545YJ	AXK5F70547YG (From Oct. 2005)	AXK6F70545YJ	AXK6F70547YG (From Oct. 2005)		
	80	AXK5F80545YJ	AXK5F80547YG (From Oct. 2005)	AXK6F80545YJ	AXK6F80547YG (From Oct. 2005)		
100	AXK5F00545YJ	AXK5F00547YG (From Oct. 2005)	AXK6F00545YJ	AXK6F00547YG (From Oct. 2005)			

- Notes: 1. Regarding ordering units, During production: Please make orders in 1-reel units.  
Samples for mounting confirmation: Available in units of 50 pieces. Please consult us. (See "Regarding sample orders to confirm proper mounting" on page 13.)  
Samples: Small lot orders are possible. Please consult us.
2. The standard type comes without positioning bosses. Connectors with positioning bosses are available for on-demand production. For this type of connector, 9th digit of the part no. changes from 4 to 3. e.g.  
Mated height 1.5mm, 10 contacts for sockets: AXK5F10337YG
3. The 11th digit "Y" in the socket/header part number indicates the connector has a V notch. (For details, please consult one of our sales offices.)

## AXK(5/6)F

## SPECIFICATIONS

## 1. Characteristics

	Item	Specifications	Conditions
Electrical characteristics	Rated current	0.5A/contact (Max. 10 A at total contacts)	
	Rated voltage	60V AC/DC	
	Breakdown voltage	150V AC for 1 minute	Detection current: 1mA
	Insulation resistance	Min. 1,000M $\Omega$ (initial)	Using 500V DC megger
	Contact resistance	Max. 90m $\Omega$	Measured based on the HP4338B measurement method of JIS C 5402
Mechanical characteristics	Composite insertion force	Max. 0.981N {100gf}/contacts $\times$ contacts (initial)	
	Composite removal force	Min. 0.0588N {6gf}/contacts $\times$ contacts	
	Post holding force	Min. 0.981N {100gf}/contact	Measures the maximum load in the post axial direction until removal
Environmental characteristics	Ambient temperature	-55°C to +85°C	No freezing at low temperatures
	Soldering heat resistance	Max. peak temperature of 245°C	Infrared reflow soldering
		300°C within 5 seconds	Soldering iron
	Thermal shock resistance (header and socket mated)	5 cycles, insulation resistance min. 100M $\Omega$ , contact resistance max. 90m $\Omega$	Sequence 1. -55 $\frac{3}{8}$ °C, 30 minutes 2. ~, Max. 5 minutes 3. 85 $\frac{3}{8}$ °C, 30 minutes 4. ~, Max. 5 minutes
	Humidity resistance (header and socket mated)	120 hours, insulation resistance min. 100M $\Omega$ , contact resistance max. 90m $\Omega$	Bath temperature 40 $\pm$ 2°C, humidity 90 to 95% R.H.
	Saltwater spray resistance (header and socket mated)	24 hours, insulation resistance min. 100M $\Omega$ , contact resistance max. 90m $\Omega$	Bath temperature 35 $\pm$ 2°C, saltwater concentration 5 $\pm$ 1%
	H <sub>2</sub> S resistance (header and socket mated)	48 hours, contact resistance max. 90m $\Omega$	Bath temperature 40 $\pm$ 2°C, gas concentration 3 $\pm$ 1 ppm, humidity 75 to 80% R.H.
Lifetime characteristics	Insertion and removal life	50 times	Repeated insertion and removal speed of max. 200 times/hours
Unit weight		Mated height 1.5mm, 20 contacts; Socket: 0.06g Header: 0.04g	

## 2. Material and surface treatment

Part name	Material	Surface treatment
Molded portion	Heat-resistant resin (UL94V-0)	—
Contact/Post	Copper alloy	Contact portion: Ni plating on base, Au plating on surface Terminal portion: Ni plating on base, Au plating on surface (Except for thick of terminal) However, the area adjacent to the terminal on Ni barrier models is exposed to Ni on base.

## DIMENSIONS

- Socket (Mated height: 1.5mm, 2.0mm, 2.5mm)



Dimension table (mm)

No. of contacts	A	B
10	5.50	2.00
12	6.00	2.50
14	6.50	3.00
16	7.00	3.50
18	7.50	4.00
20	8.00	4.50
22	8.50	5.00
24	9.00	5.50
26	9.50	6.00
30	10.50	7.00
32	11.00	7.50
34	11.50	8.00
36	12.00	8.50
40	13.00	9.50
44	14.00	10.50
50	15.50	12.00
60	18.00	14.50
70	20.50	17.00
80	23.00	19.50
100	28.00	24.50

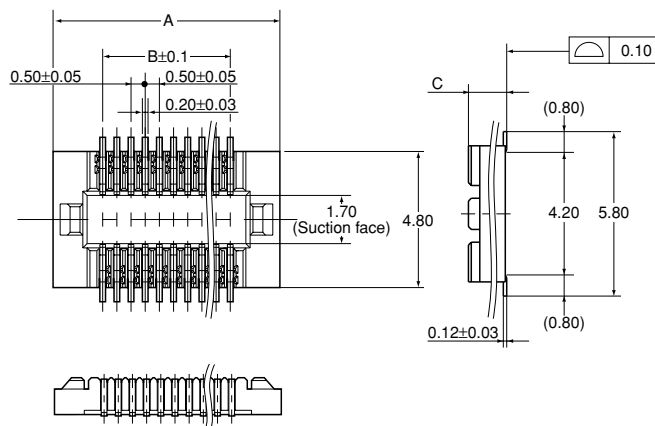

Mated height	C
1.5 mm	1.35
2.0 mm, 2.5 mm	1.85

- Header (Mated height: 1.5mm, 2.0mm, 2.5mm)



Dimension table (mm)

No. of contacts	A	B
10	5.50	2.00
12	6.00	2.50
14	6.50	3.00
16	7.00	3.50
18	7.50	4.00
20	8.00	4.50
22	8.50	5.00
24	9.00	5.50
26	9.50	6.00
30	10.50	7.00
32	11.00	7.50
34	11.50	8.00
36	12.00	8.50
40	13.00	9.50
44	14.00	10.50
50	15.50	12.00
60	18.00	14.50
70	20.50	17.00
80	23.00	19.50
100	28.00	24.50

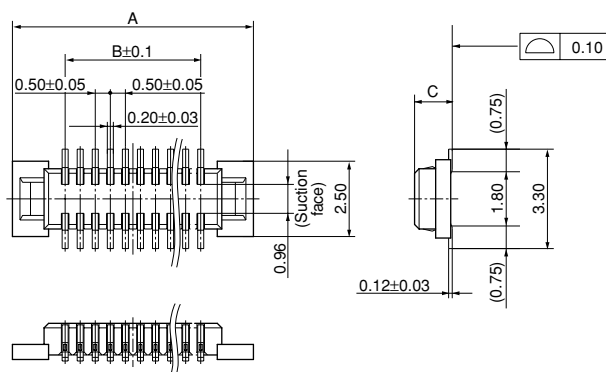

Mated height	C
1.5 mm, 2.0 mm	1.25
2.5 mm	1.75

- Socket and header are mated

Mated height: 1.5 mm

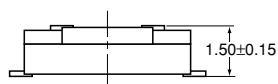

Mated height: 2.0 mm

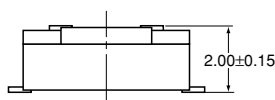

Mated height: 2.5 mm

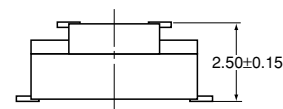

# AXK(5/6)F

## EMBOSSED TAPE DIMENSIONS (unit:mm, Common for respective contact type, socket and header)

• Tape dimensions (Conforming to JIS C 0806-1990.  
However, some tapes have mounting hole pitches that do not comply with the standard.)

• Plastic reel dimensions (Conforming to EIAJ ET-7200B)/  
Paper reel dimensions (Conforming to JIS C 0806-1990)

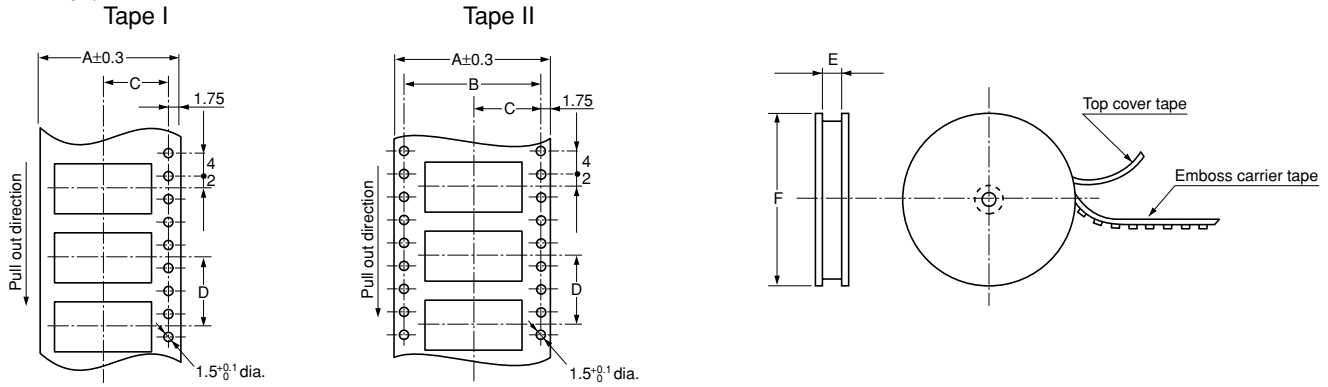

### Dimension table (mm)

(1) Suffix: P (1 reel, 2,000 pieces embossed tape: Plastic reel package) ... From Oct. 2005

Mated height	No. of contacts	Type of taping	A	B	C	D	E	F	Quantity per reel
Socket and header are common: 1.5mm, 2.0mm, 2.5mm	10 to 58	Tape I	24.0	—	11.5	12.0	25.4±1	380 dia.	2,000 pcs.
	60 to 70	Tape II	32.0	28.4	14.2	12.0	33.4±1	380 dia.	2,000 pcs.
	72 to 100	Tape II	44.0	40.4	20.2	12.0	45.4±1	380 dia.	2,000 pcs.

(2) Suffix: J (1 reel, 2,000 pieces embossed tape: Paper reel package)

Mated height	No. of contacts	Type of taping	A	B	C	D	E	F	Quantity per reel
Socket and header are common: 1.5mm, 2.0mm, 2.5mm	10 to 58	Tape I	24.0	—	11.5	12.0	24.4 <sup>+2</sup> / <sub>0</sub>	370 dia.	2,000 pcs.
	60 to 70	Tape II	32.0	28.4	14.2	12.0	32.4 <sup>+2</sup> / <sub>0</sub>	370 dia.	2,000 pcs.
	72 to 100	Tape II	44.0	40.4	20.2	12.0	44.4 <sup>+2</sup> / <sub>0</sub>	370 dia.	2,000 pcs.

### Connector orientation with respect to direction of progress of embossed tape

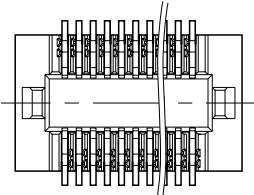
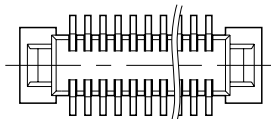
Direction of tape progress  ↓	Type	Common for P5KF	
	Socket	Header	
			

Note: There is no indication on this product regarding top-bottom or left-right orientation.

# Narrow Pitch Connector P5KF (0.5 mm pitches) for Inspection Usage

## CONNECTOR FOR INSPECTION USAGE APPLICATIONS WITH 3,000 INSERTION AND REMOVAL TIMES



Socket



Header

### FEATURES

#### 1. 3,000 insertion and removals (when as recommended)

From the 50 insertion and removals of standard type, up to 3,000 insertion and removals (with recommended insertion and removal) are possible for use in inspection.

Ideal for inspection of module units and inspection during the device assembly process

#### 2. Same external dimensions and foot pattern as standard type.

Since shape is the same as standard type, inspection is possible without interfering with devices in the vicinity of standard connectors.

#### 3. Improved mating

Insertion and removal have become easier due to a reduction in the mating retention force required by the simple locking structure and also in the amount of force needed for insertion and removal. (We cannot warrant anything regarding mating retention.)

### TABLE OF PRODUCT TYPES

☆: Available for sale

Product name	P5KF for inspection
10	☆
12	☆
14	☆
16	☆
18	☆
20	☆
22	☆
24	☆
26	☆
30	☆
32	☆
34	☆
40	☆
50	☆
60	☆
70	☆
80	☆
100	☆

Notes:

1. You can use with each mated height in common.
2. Please inquire about numbers of contacts other than those given above.
3. Please inquire with us regarding delivery times.
4. Please keep the minimum unit for ordering no less than 50 pieces per lot.
5. Please inquire for further information.

# AXK(5/6)F

## NOTES

1. As shown below, excess force during insertion may result in damage to the connector or removal of the solder. Please be careful. Also, to prevent connector damage please confirm the correct position before mating connectors.

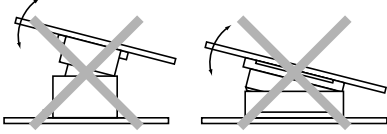

2. Keep the PC board warp no more than 0.03 mm in relation to the overall length of the connector.

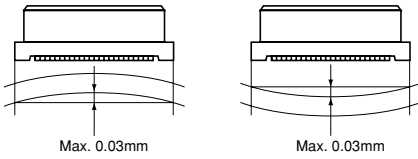

### 3. PC Boards and Recommended Metal Mask Patterns

Connectors are mounted with high density, with a pitch interval of 0.4 to 0.5 mm. It is therefore necessary to make sure that the right levels of solder are used, in order to reduce solder bridge and other issues. The figures to the right are recommended metal mask patterns. Please use them as a reference.

#### • Socket

Recommended PC board pattern (TOP VIEW)

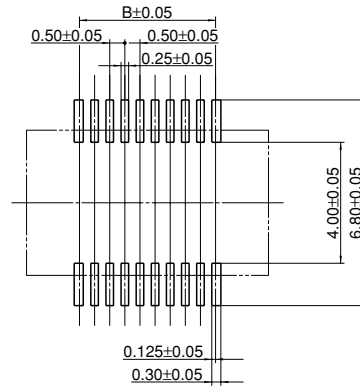

Recommended metal mask pattern  
Metal mask thickness: Here, 150 μm  
(Opening area ratio: 56%)

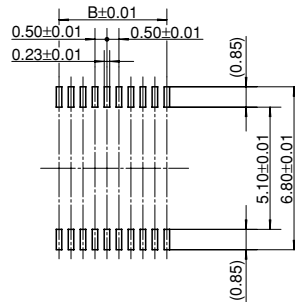

Recommended metal mask pattern  
Metal mask thickness: Here, 120 μm  
(Opening area ratio: 69%)

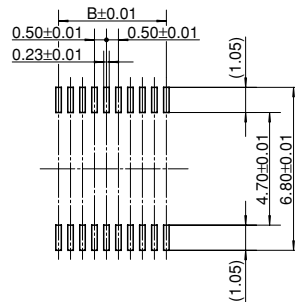

#### • Header

Recommended PC board pattern (TOP VIEW)

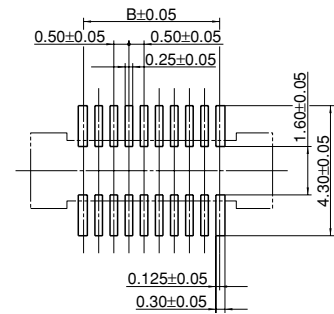

Recommended metal mask pattern  
Metal mask thickness: Here, 150 μm  
(Opening area ratio: 58%)

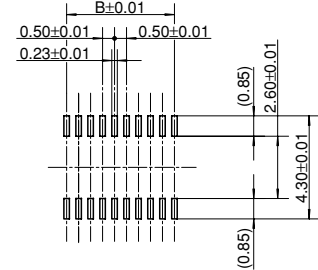

Recommended metal mask pattern  
Metal mask thickness: Here, 120 μm  
(Opening area ratio: 72%)

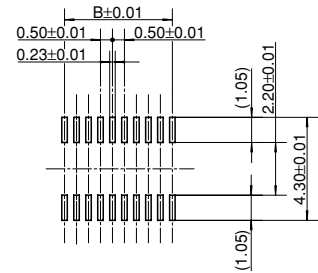

\* See the dimension table for more information on the B dimension of the socket and header.

Regarding general notes, please refer to page 12.

For other details, please verify with the product specification sheets.