

APBA3010SURKSGC

HYPER RED

SUPER BRIGHT GREEN

Features

- 3.0mmx1.0mm RIGHT ANGLE SMT LED, 2.0mm THICKNESS.
- LOW POWER CONSUMPTION.
- WIDE VIEWING ANGLE.
- IDEAL FOR BACKLIGHT AND INDICATOR.
- VARIOUS COLRS AND LENS TYPES AVAILABLE.
- PACKAGE : 2000PCS / REEL.

Description

The Hyper Red source color devices are made with DH InGaAlP on GaAs substrate Light Emitting Diode.

The Super Bright Green source color devices are made with Gallium Phosphide Green Light Emitting Diode.

Package Dimensions

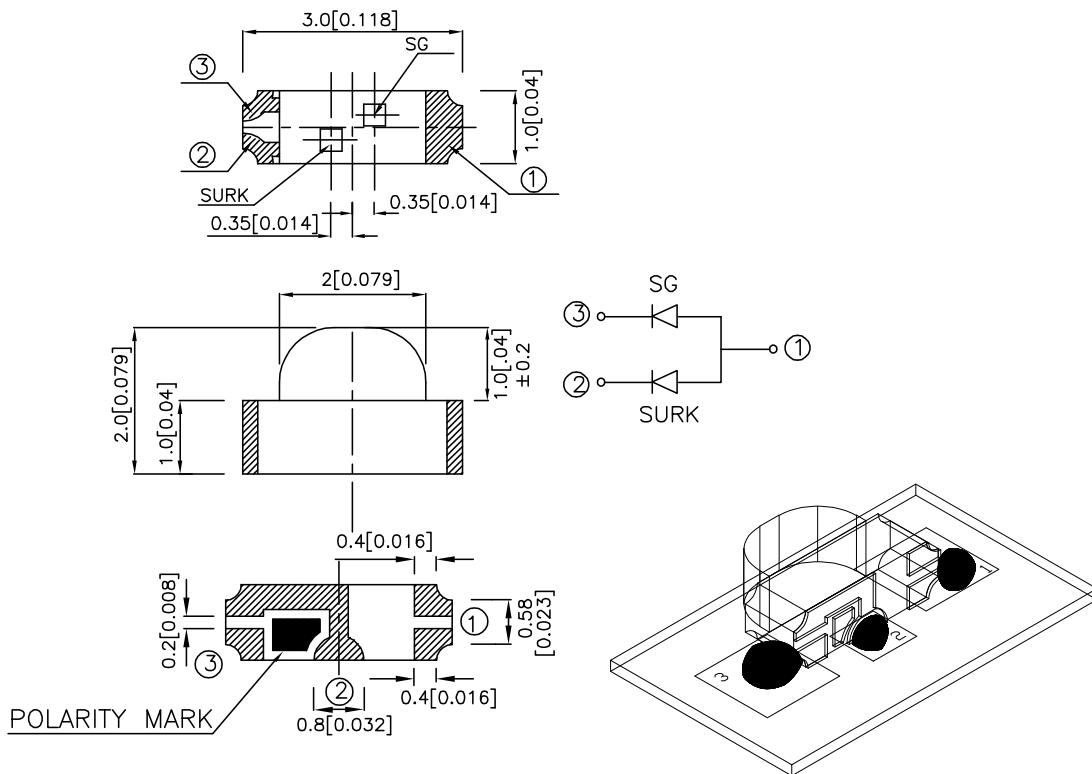

Notes:

1. All dimensions are in millimeters (inches).
2. Tolerance is ± 0.15 (0.006") unless otherwise noted.
3. Specifications are subject to change without notice.

Selection Guide

Part No.	Dice	Lens Type	Iv (mcd) @ 20mA		Viewing Angle
			Min.	Typ.	2 θ 1/2
APBA3010SURKSGC	HYPER RED (InGaAlP)	WATER CLEAR	110	200	140°
	SUPER BRIGHT GREEN (GaP)		2.6	12	

Note:

1. θ1/2 is the angle from optical centerline where the luminous intensity is 1/2 the optical centerline value.

Electrical / Optical Characteristics at TA=25°C

Symbol	Parameter	Device	Typ.	Max.	Units	Test Conditions
λ_{peak}	Peak Wavelength	Hyper Red Super Bright Green	650 565		nm	IF=20mA
λ_D	Dominate Wavelength	Hyper Red Super Bright Green	635 568		nm	IF=20mA
$\Delta\lambda_{1/2}$	Spectral Line Half-width	Hyper Red Super Bright Green	28 30		nm	IF=20mA
C	Capacitance	Hyper Red Super Bright Green	35 15		pF	VF=0V;f=1MHz
VF	Forward Voltage	Hyper Red Super Bright Green	1.95 2.2	2.5 2.5	V	IF=20mA
IR	Reverse Current	All		10	uA	VR = 5V

Absolute Maximum Ratings at TA=25°C

Parameter	Hyper Red	Super Bright Green	Units
Power dissipation	170	105	mW
DC Forward Current	30	25	mA
Peak Forward Current [1]	185	140	mA
Reverse Voltage	5	5	V
Operating / storage Temperature	-40°C To +85°C		

Note:

1. 1/10 Duty Cycle, 0.1ms Pulse Width.

Kingbright

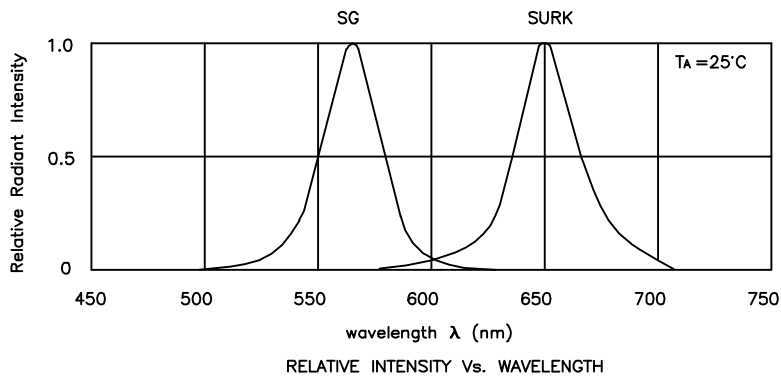

APBA3010SURKSGC Hyper Red

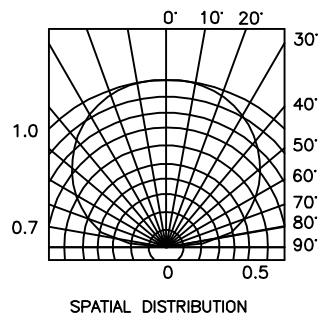
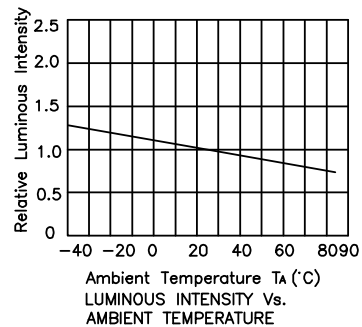
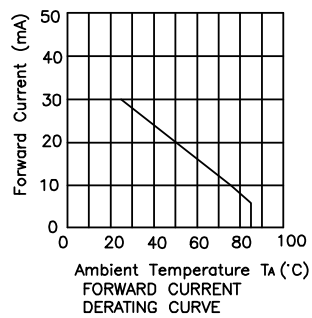
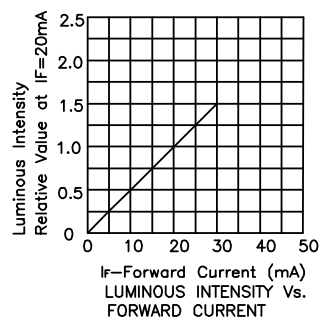
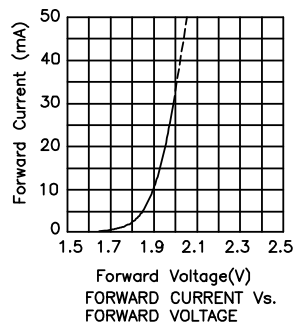

Kingbright

Super Bright Green

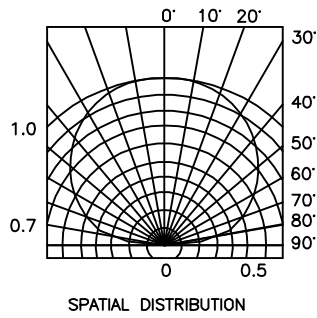
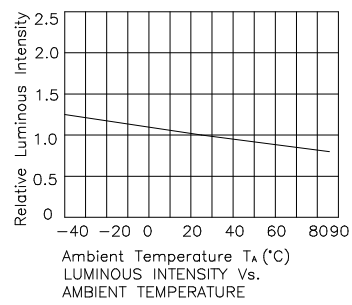
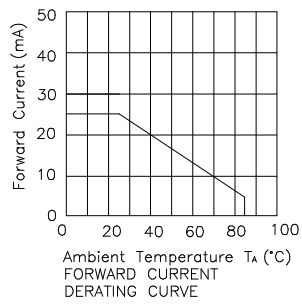
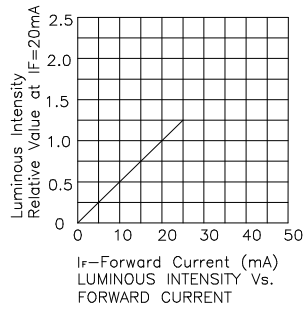
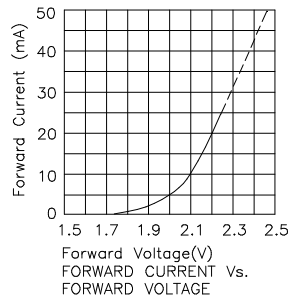

APBA3010SURKSGC SMT Reflow Soldering Instructions

Number of reflow process shall be less than 2 times and cooling process to normal temperature is required between first and second soldering process.

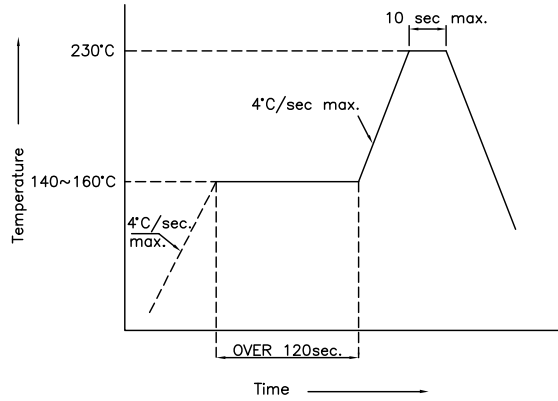

Recommended Soldering Pattern (Units : mm)

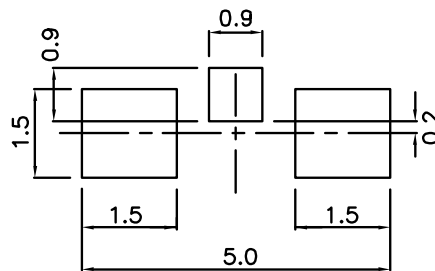

Tape Specifications (Units : mm)

