

# Model TA5G

## 5.0x7.0mm

### Surface Mount TCXO

# CONNOR WINFIELD

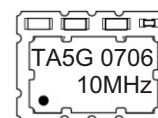

2111 Comprehensive Drive

Aurora, Illinois 60505

Phone: 630-851-4722

Fax: 630-851-5040

www.conwin.com

US Headquarters

630-851-4722:

European Headquarters:

+353-61-472221

#### Description

The Connor Winfield model TA5G is a 5x7mm Surface Mount Temperature Compensated Crystal Controlled Oscillators (TCXO) with a Tri-State LVCMOS output. The TA5G is designed for applications requiring high frequency stability, low jitter over the commercial temperature range. The RoHS compliant, surface mount package is design for high-density mounting and is optimum for mass production.

#### Features

TCXO  
3.3V Operation  
LVCMOS Output Logic  
Frequency Stability:  $\pm 2.50$ ppm  
Temperature Range: 0 to 70°C  
Low Jitter < 1ps RMS  
Tri-State Enable/Disable Function  
Surface Mount Package  
Tape and Reel Packing  
RoHS Compliant / Lead Free

#### ABSOLUTE MAXIMUM RATINGS

TABLE 1

PARAMETER	UNITS	MINIMUM	NOMINAL	MAXIMUM	UNITS	NOTE
Storage Temperature		-55	-	125	°C	
Supply Voltage	(Vcc)	-0.5	-	6.0	Vdc	

#### OPERATING SPECIFICATIONS

TABLE 2

PARAMETER	MINIMUM	NOMINAL	MAXIMUM	UNITS	NOTE
Frequency Range	6.4	-	52	MHz	
Frequency Calibration @ 25 C	-1.00	-	1.00	ppm	1
Frequency Stability	-2.50	-	2.50	ppm	2
Operating Temperature Range	0	-	70	°C	
Aging First Year	-1.00	-	1.00	ppm	
Aging Per Year	-1.00	-	1.00	ppm	
Supply Voltage Variation.	-	-	$\pm 0.2$	ppm	
Load Coefficient, $\pm 5$ pF	-	-	$\pm 0.2$	ppm	
Supply Voltage	(Vcc)	3.135	3.3	3.465	Vdc
Supply Current	(Icc)	-	6	10	mA
Jitter (BW=10Hz to 20MHz)	-	-	5	ps rms	
Jitter (BW=12kHz to 20MHz)	-	-	1	ps rms	
SSB Phase Noise at 10Hz offset	-	-	-80	dBc/Hz	
SSB Phase Noise at 100Hz offset	-	-	-110	dBc/Hz	
SSB Phase Noise at 1KHz offset	-	-	-135	dBc/Hz	
SSB Phase Noise at $\geq 10$ KHz offset	-	-	-150	dBc/Hz	

#### INPUT CHARACTERISTICS for ENABLE / DISABLE FUNCTION (Pin 8)

TABLE 3

PARAMETER	MINIMUM	NOMINAL	MAXIMUM	UNITS	NOTE	
Enable Voltage (High) or open circuit	(Vih)	70% Vdd	-	-	Vdc	3
Disable Voltage (Low) Output Tri-stated	(Vil)	-	-	30% Vdd	Vdc	

#### LVCMOS OUTPUT CHARACTERISTICS

TABLE 4

PARAMETER	MINIMUM	NOMINAL	MAXIMUM	UNITS	NOTE
LOAD	-	-	15	pF	
Voltage (High)	(Voh)	90%Vcc	-	-	Vdc
(Low)	(Vol)	-	-	10%Vcc	Vdc
Current (High)	(Ioh)	-4	-	-	mA
(Low)	(Iol)	-	-	4	mA
Duty Cycle at 50% of Vcc	45	50	55	%	
Rise / Fall Time 10% to 90%	-	-	8	ns	

#### Note:

- 1) Initial calibration @ 25 C. Specifications at time of shipment after 48 hours of operation.
- 2) Frequency stability vs. change in temperature.  $[\pm(F_{max} - F_{min})/2.F_0]$
- 3) Leave Pad 8 unconnected if enable / disable function is not required. When tri-stated, the output stage is disabled but the oscillator and compensation circuit are still active (current consumption  $\leq 1$  mA).



Bulletin Tx182

Page 1 of 2

Revision 00

Date 01 Feb 2007

**PACKAGE CHARACTERISTICS**

Package	Ceramic Surface Mount Package.
---------	--------------------------------

**TABLE 5**

**ENVIRONMENTALS**

Vibration:	Vibration per Mil Std 883E Method 2007.3 Test Condition A
Shock:	Mechanical Shock per Mil Std 883E Method 2002.4 Test Condition B.
Soldering:	See solder profile page.
Solderability	Solderability per Mil Std 883E Method 2003

**TABLE 6**

**PIN CONNECTIONS**

**TABLE 7**

Pin	Connection
1	Do not connect
2	Do not connect
3	Do not connect
4	Ground
5	Output
6	Do not connect
7	Do not connect
8	Tri-state Enable / Disable
9	Supply, Vcc
10	Do not connect

**PACKAGE DRAWING**

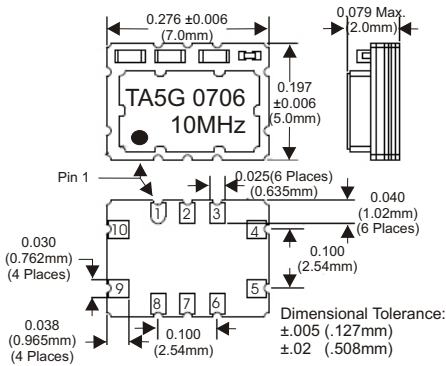

**SUGGESTED PAD LAYOUT**

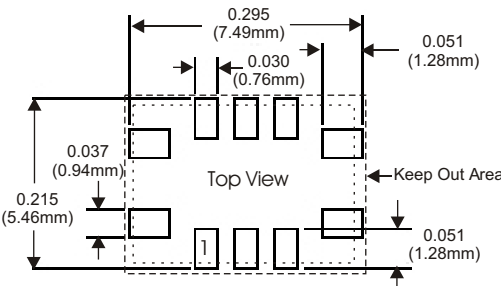

**OUTPUT WAVEFORM**

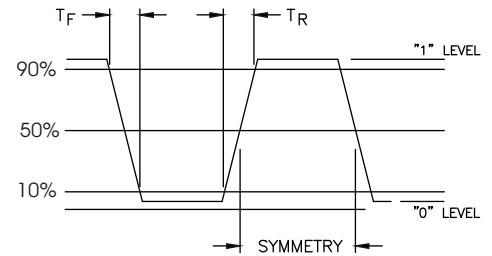

**TEST CIRCUIT**

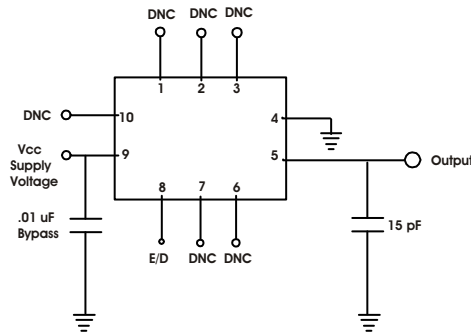

**SOLDER PROFILE**

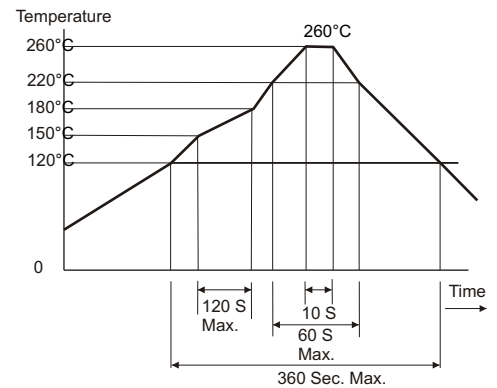

**Tape and Reel Information**

MEETS EIA-481A AND EIAJ-1009B  
2000 PCS/REEL MAXIMUM

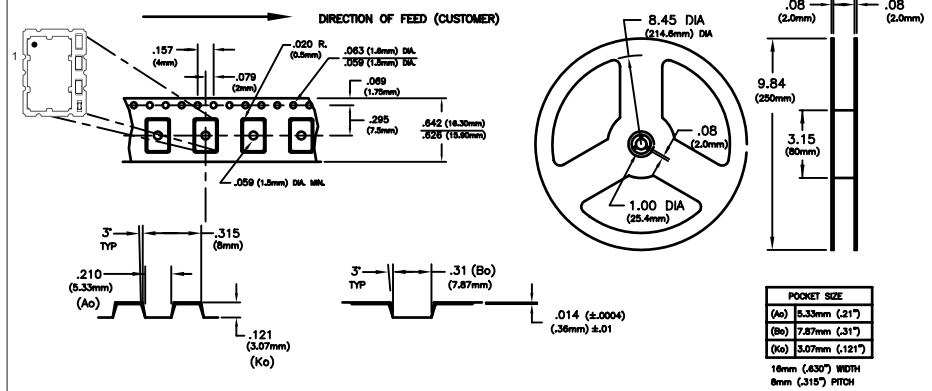

US Headquarters:  
630-851-4722  
European Headquarters:  
+353-61-472221

**ORDERING INFORMATION**

TA5G - 10 MHz  
TCXO SERIES CENTER FREQUENCY

Bulletin	Tx182
Page	2 of 2
Revision	00
Date	01 Feb 2007