

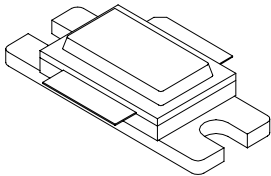

MDS500L

500 Watts, 50 Volts, Pulsed
Avionics 1030 - 1090 MHz

<p>GENERAL DESCRIPTION</p> <p>The MDS500L is a high power COMMON BASE bipolar transistor. It is designed for MODE-S ELM systems in the 1030 - 1090 MHz frequency band. The transistor includes input and output prematch for broadband performance. The device has gold thin-film metallization and diffused ballasting in a hermetically sealed package for proven highest MTTF.</p>	<p>CASE OUTLINE 55ST Style 1</p> 
<p>ABSOLUTE MAXIMUM RATINGS</p> <p>Maximum Power Dissipation Device Dissipation @25°C¹ 833 W</p> <p>Maximum Voltage and Current Collector to Emitter Voltage (BV_{ces}) 70 V Emitter to Base Voltage (BV_{ebo}) 3.5 V Peak Collector Current (I_c) 24 A</p> <p>Maximum Temperatures Storage Temperature -65 to +150 °C Operating Junction Temperature +200 °C</p>	

ELECTRICAL CHARACTERISTICS @ 25°C

SYMBOL	CHARACTERISTICS	TEST CONDITIONS	MIN	TYP	MAX	UNITS
P _{out}	Power Out	F = 1030, 1090 MHz	500			W
P _{in}	Power Input	V _{cc} = 50 Volts			60	W
P _g	Power Gain	PW = Note 2	9.2			dB
η _c	Collector Efficiency	DF = Note 2		50		%
VSWR	Load Mismatch Tolerance				2:1	
Pd ¹	Pulse Droop				0.8	dB
Trise ¹	Rise Time				100	nSec

FUNCTIONAL CHARACTERISTICS @ 25°C

BV _{ebo}	Emitter to Base Breakdown	I _e = 15 mA	3.0			V
BV _{ces}	Collector to Emitter Breakdown	I _c = 50 mA	70			V
BV _{cbo}	Collector to Base Breakdown	I _c = 50 mA	70			V
I _{ces}	Collector to Emitter Leakage	V _{ce} = 50V			15	mA
h _{FE}	DC – Current Gain	V _{ce} = 5V, I _c = 1.0 A	20			
θ _{jc} ¹	Thermal Resistance				0.08	°C/W

NOTE 1: AT RATED OUTPUT POWER AND PULSE CONDITIONS

NOTE 2: ELM Burst: 32μSec ON/ 18μSec OFF x 48, repeated at 23mSec

REV C – March 2008

Microsemi reserves the right to change, without notice, the specifications and information contained herein. Visit our web site at www.microsemi.com or contact our factory direct.

MDS500L SAMPLE RF DATA (SN#7-23; WO#51157X)

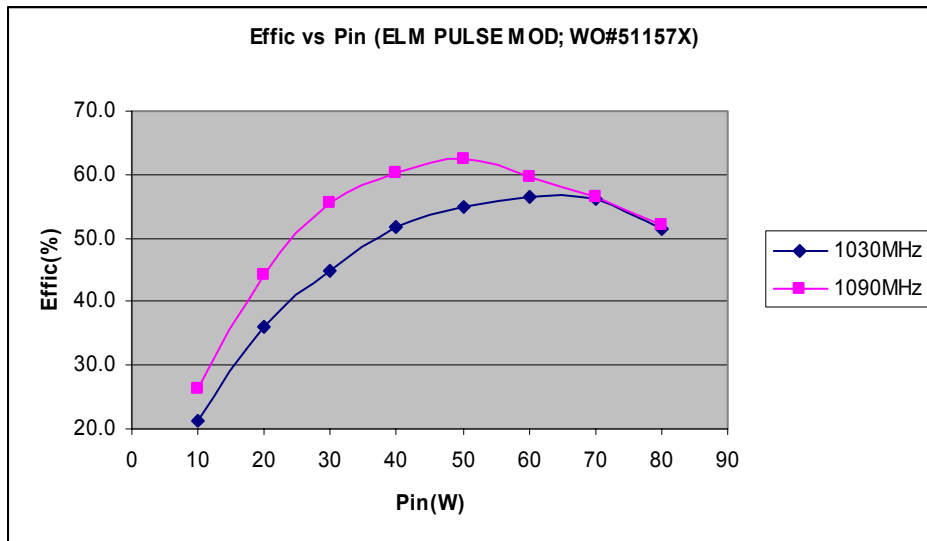
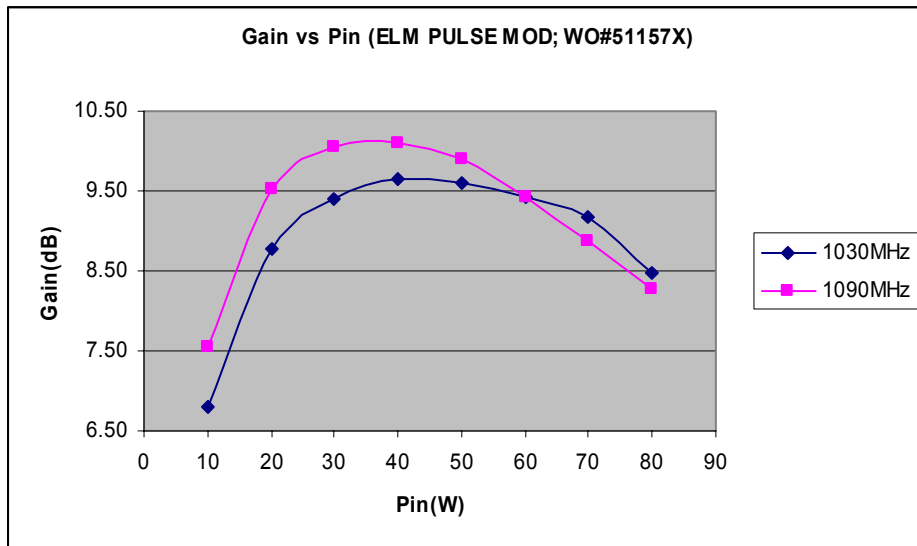
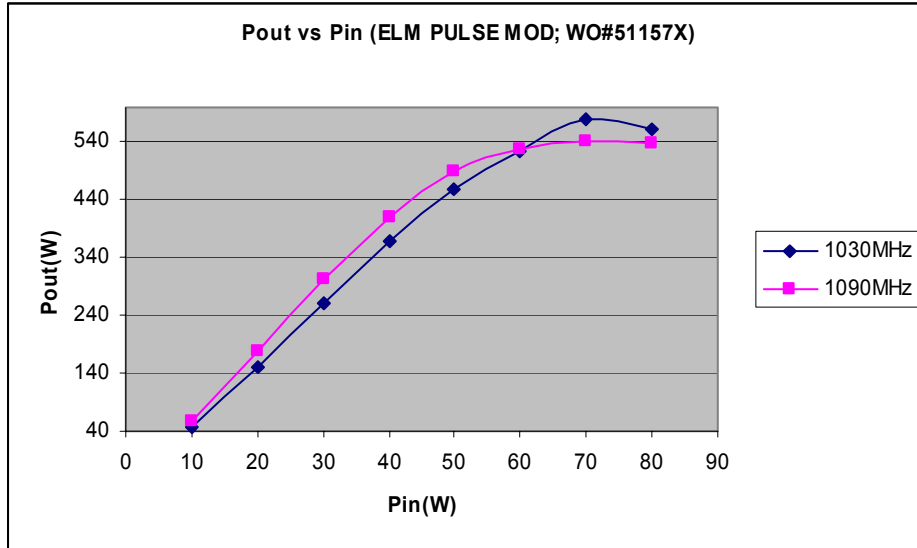

MDS500L TEST FIXTURE

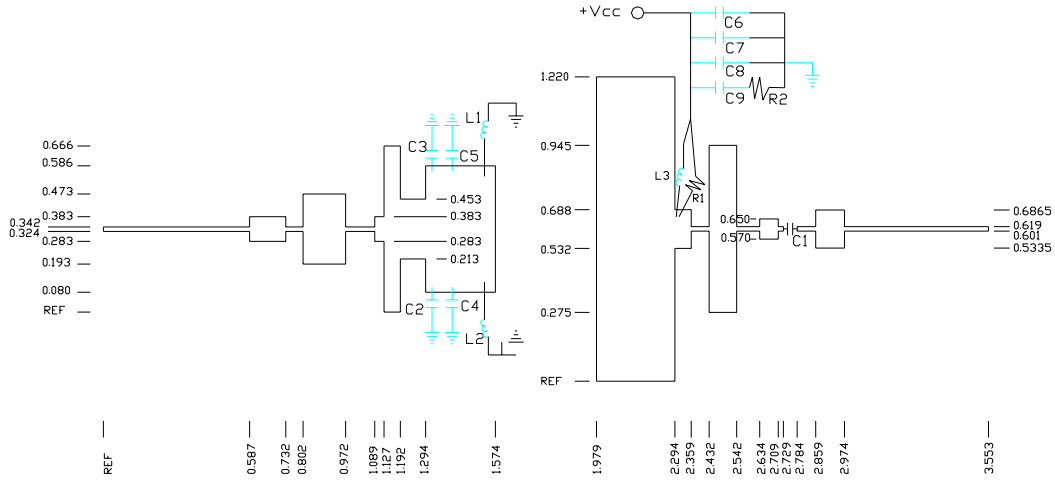

C1: 100pF ATC chip cap
 C2=C3: 5.1pF ATC chip cap, size B
 C4=C5: 1.0pF ATC chip cap, size B
 C6: 6800uF electrolytic cap, 63V
 C7: 91pF ATC chip cap, size B
 C8: 39pF ATC chip cap, size B
 C9: 0.1uF ATC chip cap, size B

R1: 4.3 ohm, 1/4W resistor
 R2: 15ohm chip resistor
 L1=L2: #18 AWG, length=1 inch
 L3: #18 AWG, 4 turn
 Substrate: Er=10.2, H=25mils
 Frequency = 1030-1090MHz
 Dimensions: inches

IMPEDANCE DATA

FREQUENCY	Z _{source} (ohms)	Z _{load} (ohms)
1030	1.90 - j1.60	1.79 - j1.51
1090	2.10 - j1.61	2.05 - j1.76
1150	2.26 - j1.82	2.21 - j2.21

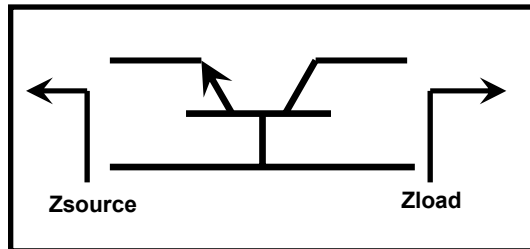

MDS500L

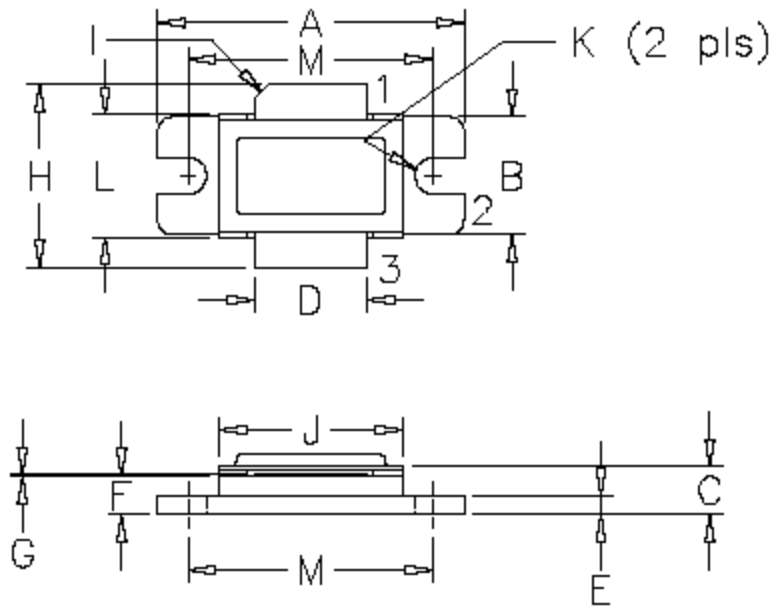

DIM	MILLIMETER	TOL	INCHES	TOL
A	25.40	.25	1.000	.010
B	9.78	.25	.385	.010
C	4.00	.19	.142	.007
D	9.40	.13	.370	.005
E	1.53	.13	.060	.005
F	3.18	.13	.125	.005
G	0.08	$^{+.002}/_{-.000}$.003	$^{+.002}/_{-.000}$
H	19.05	0.51	.750	.020
I	45°	5°	45°	5°
J	15.24	.25	.600	.010
K	3.05 DIA	.13	.120 DIA	.005
L	10.15	.13	.400	.005
M	20.32	.25	.800	.010

STYLE 1:
PIN 1 = COLLECTOR
2 = BASE
3 = EMITTER

STYLE 2:
PIN 1 = COLLECTOR
2 = EMITTER
3 = BASE

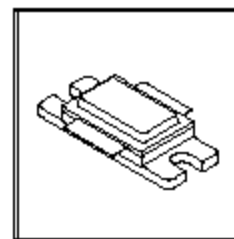

DWG NO.

55ST