

PLL FREQUENCY SYNTHESIZER AND CONTROLLER FOR FM/MW/LW TUNER

The μ PD1708AG-011/ μ PD1708AG-211, a CMOS LSI chip developed for Europe, USA and Oceania, incorporating PLL frequency synthesizer, controller, prescaler and LCD driver.

It is a 52 pin Plastic flat package and it has selection function for manual tuning by push button or rotary switch. μ PD1708AG-011/ μ PD1708AG-211 can be constructed incorporating many function and high performance FM/MW/LW digital tuning system.

FEATURES

- FM/MW/LW stations in Europe, USA and Australia can be selected.
- LCD driver (5 V \pm 10 % drive, 1/2 duty, 1/2 bias frame frequency: 100 Hz)
- Built-in prescaler (150 MHz)
- Rotary switch and push button can be selected for manual tuning.
- Preset memory display with 7 segment digits
- Preset station memories for 18 stations (FM, 6; MW, 6; LW, 6)
- Last station memories for each FM/MW/LW station (total three stations).
- IF of AM is 450 kHz for USA and Oceania; 459 kHz for Europe.
- Built-in clock (24 hour system for Europe, 12 hour system for USA and Oceania).
- Single power supply 5 V \pm 10 %
- 52 pin plastic flat package
- Selectable lead type

Lead bent type : μ PD1708AG-011-00

Straight lead type: μ PD1708AG-211-03

FUNCTIONS

Receiving frequencies, channel spacing, reference frequencies, and intermediate frequencies

AREA	BAND	FREQUENCY RANGE	CHANNEL SPACING	REFERENCE FREQUENCY	INTERMEDIATE FREQUENCY
Europe	FM	87.5 to 108.0 MHz	50 kHz	12.5 kHz	10.650, 10.675, 10.700, 10.725 MHz
	MW	522 to 1 620 kHz	9 kHz	9 kHz	459 kHz
	LW	146 to 290 kHz	Auto 9 kHz	1 kHz	459 kHz
Manual 1 kHz					
USA	FM	87.5 to 107.9 MHz	200 kHz	12.5 kHz	10.650, 10.675, 10.700, 10.725 MHz
	MW	530 to 1 620 kHz	10 kHz	10 kHz	450 kHz
Oceania	FM	87.5 to 108.0 MHz	100 kHz	12.5 kHz	10.650, 10.675, 10.700, 10.725 MHz
	MW	522 to 1 620 kHz	9 kHz	9 kHz	450 kHz

Radio Functions

- (1) Auto up/down tuning (sawtooth wave mode)

Scan up) Reception every 8 seconds
 Scan down)
 Seek up) Received station is held
 Seek down)

The MANUAL UP or MANUAL DOWN key is used to select the up or down direction of scanning or seek.

- (2) Manual up/down tuning (sawtooth wave mode)

MANUAL UP) The momentary switch is used for step by step tuning. If this switch is pressed for 0.5 second or longer, high-speed tuning continues until the switch is released. On the other hand, the rotary switch can be used for tuning based on the pulse count modulation method.

- (3) Preset station memory call Six stations can be preset with six buttons for each band
 Six stations can be preset with one button for each band
- (4) Last station memory each FM, MW, LW band
- (5) Band selection

USA and Oceania → FM → MW →

Europe → FM → MW → LW →

Display Functions

- (1) Dynamic display by incorporating LCD driver
- (2) Preset memory display with 7 segment digits

Clock Functions

- (1) Display
 - USA and Oceania12 hour system (display of AM/PM)
 - Europe 24 hour system
- (2) Independent adjustment of minute and second (by pressing the ME and MU/MD keys simultaneously)

Tape Recorder Functions

- (1) METAL control output
- (2) Dolby NR* control output
- (3) MSS control output
- (4) LOUDNESS control output

* Dolby® and the double-D symbol are registered trademarks of Dolby Laboratories Licensing Corporation.

PIN CONFIGURATION (Top View)

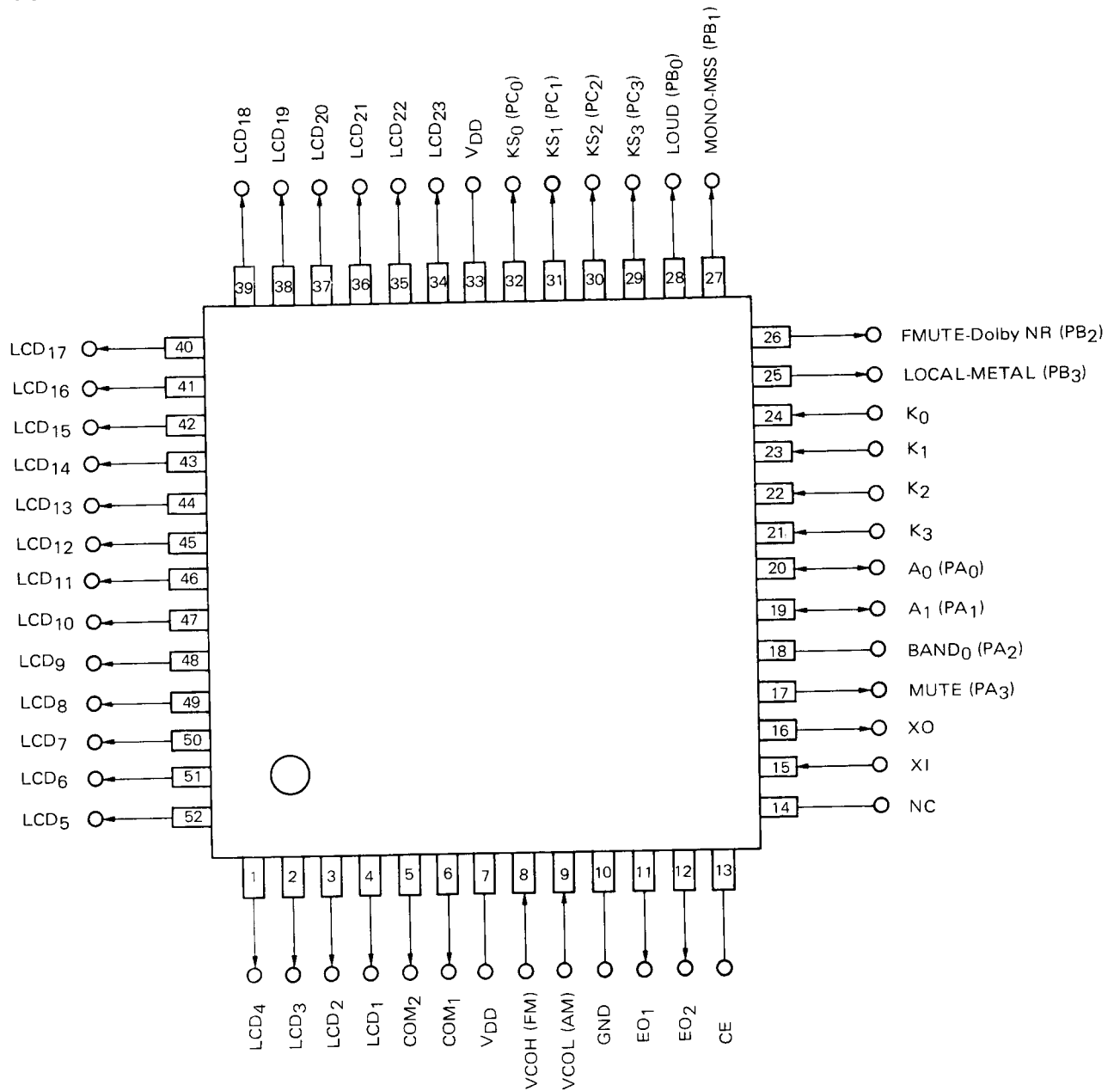

NC (No Connection)

PIN DESCRIPTION

PIN NO.	PIN SYMBOL	PIN NAME	DESCRIPTION
1 to 4 34 to 52	LCD ₄ to LCD ₁ LCD ₂₃ to LCD ₅	LCD segment signal out	LCD segment signal output pins. (1/2 duty, 1/2 bias)
5 6	COM ₁ COM ₂	LCD common signal out	LCD common signal output pins.
7 33	VDD	Power input	Device power pin. 5 V ±10 % is supplied during PLL operation and 3.5 – 5.5 V is supplied during operation of a clock only. Voltage may be supplied to either pin 7 or pin 33.
8	VCOH(FM)	VCO input for FM	Pin to input FM station output. Cut DC with a capacitor because an AC amplifier is built in.
9	VCOL(AM)	VCO input for MW/LW	Pin to input MW/LW station output. Cut DC with a capacitor because an AC amplifier is built in.
10	GND	Ground	Connect to system ground.
11 12	EO ₁ EO ₂	Error output	Pins to output a charge pump of the phase detector constituting PLL. If the divided oscillation frequency is higher than the reference frequency, high level signals are output from these pins; otherwise, low level signals are output. If they are the same, floating occurs. Since the same signals are output to EO ₁ and EO ₂ , they may be connected to any LPF (low pass filter) of FM, MW, and LW.
13	CE	Chip enable	Device selection signal input pin. High level . . . Normal operation Low level . . . No display, PLL operation stop, operation of clock only, memory holding All data can be displayed by setting the CE pin to low level and port A0 to high level for checking.
14	NC	No connection	This terminal is not connected with anything.
15 16	XI XO	Crystal oscillator	Crystal oscillator connection pins. A 4.5 MHz crystal oscillator is connected.
17	MUTE	Mute output	Pin to output the muting signal for eliminating the shock noise emitted when PLL lock is unlocked and the pop sound emitted during TAPE/RADIO selection (active high). (See the MUTE output timing chart for details.)
18	BAND0	FM/MW selection	Output pin for FM/MW selection. A high level signal is output when FM is selected; a low level signal is output when MW is selected.
19 20	A ₀ A ₁	Port A ₀ Port A ₁	Output signal pins used to receive the diode initial set matrix only when the device is reset first. After this, these pins are used to input key matrix key return signals.
21 to 24	K ₃ to K ₀	Key return signal input	Key matrix key return signal input pins.
25	LOCAL-METAL	LO/DX and METAL output pin	LO/DX output pin in the RADIO mode (active high). METAL output pin in the TAPE mode (active high).

PIN NO.	PIN SYMBOL	PIN NAME	DESCRIPTION												
26	FMUTE-Dolby NR	FM MUTE and Dolby NR output & BAND1	<p>FM MUTE output pin in the RADIO mode (active low). Dolby NR output pin in the TAPE mode (active low). For use in Europe, this pin is used as an LW band output pin.</p> <table border="1"> <thead> <tr> <th>BAND PIN</th> <th>FM</th> <th>MW</th> <th>LW</th> </tr> </thead> <tbody> <tr> <td>BAND0</td> <td>1</td> <td>0</td> <td>0</td> </tr> <tr> <td>BAND1</td> <td>0</td> <td>0</td> <td>1</td> </tr> </tbody> </table> <p>1: High level 0: Low level</p>	BAND PIN	FM	MW	LW	BAND0	1	0	0	BAND1	0	0	1
BAND PIN	FM	MW	LW												
BAND0	1	0	0												
BAND1	0	0	1												
27	MONO-MSS	MONO/STEREO and MSS output	<p>MONO/STEREO output pin in the RADIO mode (active high). MSS output pin in the TAPE mode (active high).</p>												
28	LOUD	LOUD output pin	<p>LOUDNESS output pin (active high). This pin operates in both the RADIO and TAPE modes.</p>												
29 to 32	KS ₃ to KS ₀	Key source	Key matrix signal source output pin.												

CONTENTS

1.	KEY MATRIX	8
1.1	CONFIGURATION OF KEY MATRIX	8
1.2	SWITCH CONNECTION	8
1.3	KEY MATRIX CONNECTION	9
1.4	DESCRIPTION OF KEY MATRIX	10
2.	DISPLAY	18
2.1	DISPLAY CONNECTION	18
2.2	DISPLAY TYPE	20
2.3	DESCRIPTION OF DISPLAY	20
2.4	LCD DRIVE SIGNAL	21
3.	TIMING CHARTS	22
4.	APPRICATION CIRCUIT	24
5.	ELECTRICAL CHARACTERISTICS	25
5.1	ABSOLUTE MAXIMUM RATINGS	25
5.2	RECOMMENDED OPERATING CONDITIONS	25
5.3	DC CHARACTERISTICS	25
5.4	AC CHARACTERISTICS	26
6.	PACKAGE DIMENSION	27

1. KEY MATRIX

1.1 CONFIGURATION OF KEY MATRIX

	K ₀ (24)	K ₁ (23)	K ₂ (22)	K ₃ (21)	A ₀ (20)	A ₁ (19)
KS ₀ (32)	LOUD	MONO-MSS	LOCAL-METAL	FMUTE-Dolby NR	RECALL	MEMORY ENABLE
KS ₁ (31)	M2	M3	M4	M5	M6	BAND
KS ₂ (30)	SD	M1	SCAN	SEEK	MANUAL DOWN	MANUAL UP
KS ₃ (29)	POWER	RADIO	STEREO	ROTARY		
A ₀ (20)	KEY1	KEY2	KEY3	TAPE RUN		
A ₁ (19)	KEY4	KEY5	KEY6	IF2		



Momentary switch

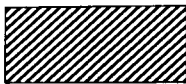

Alternate or transistor switch



Diode matrix (diode short circuit or open)

1.2 SWITCH CONNECTION

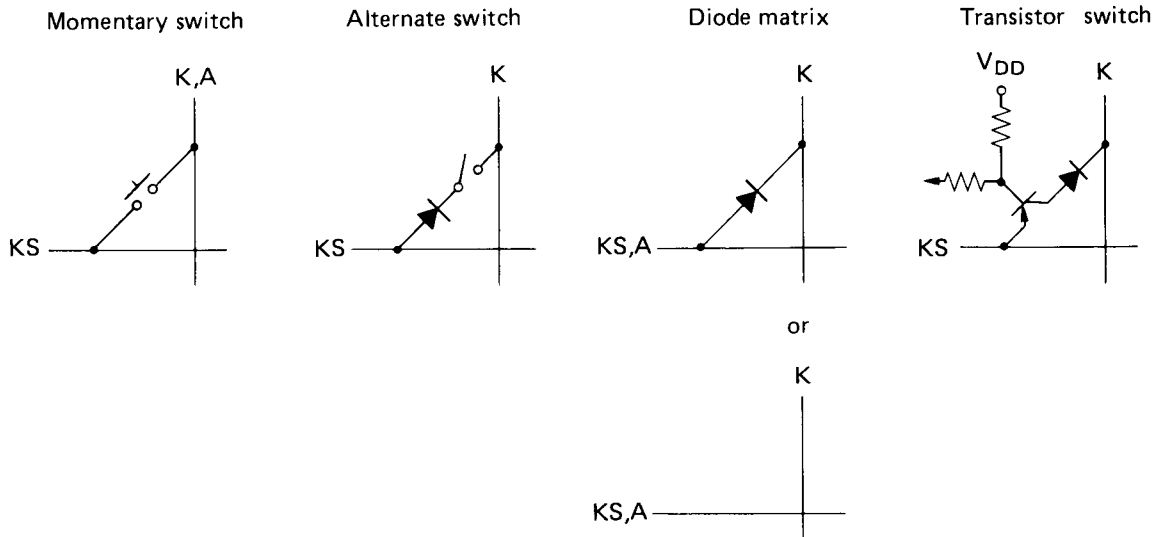

1.3 KEY MATRIX CONNECTION

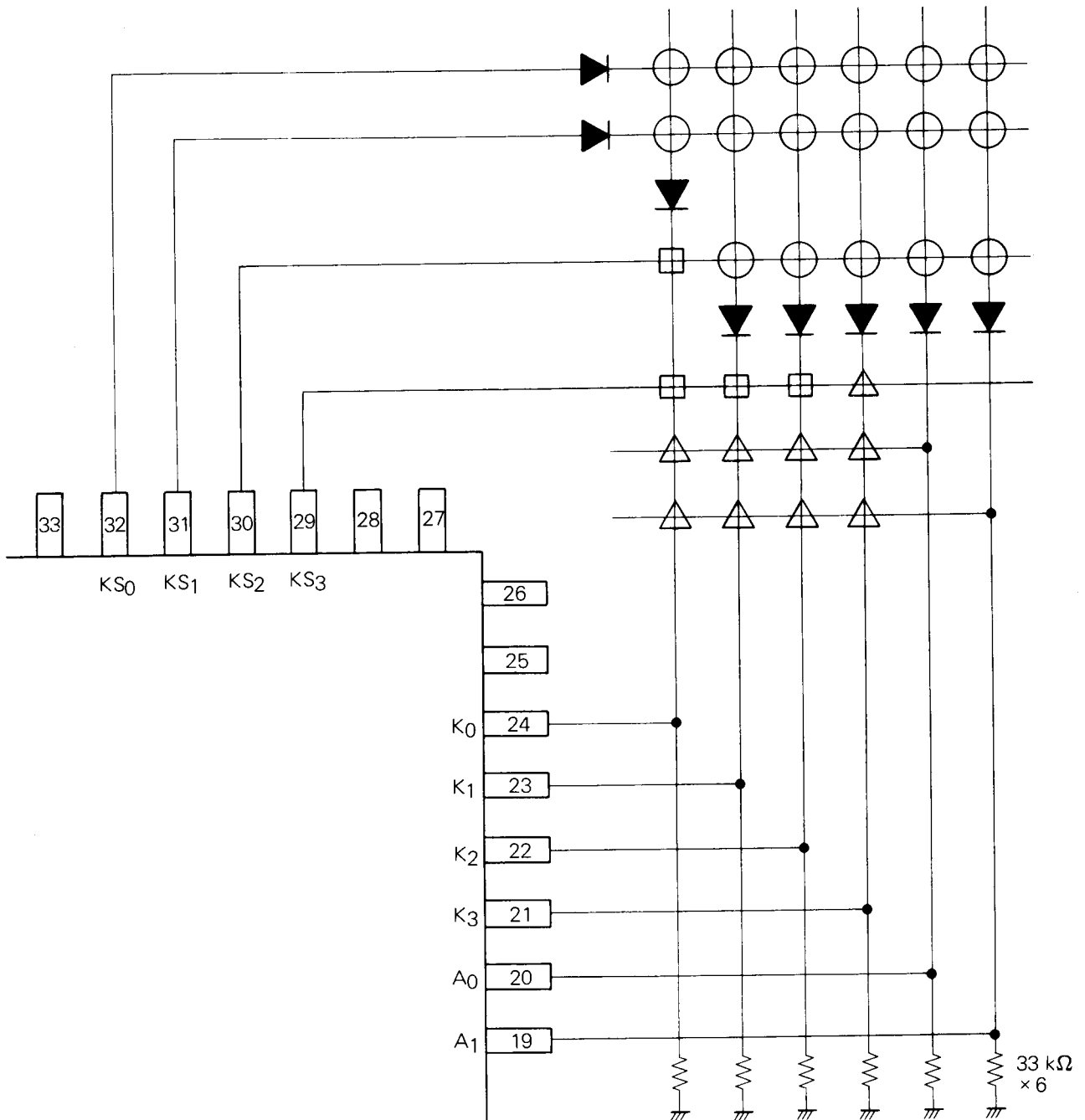
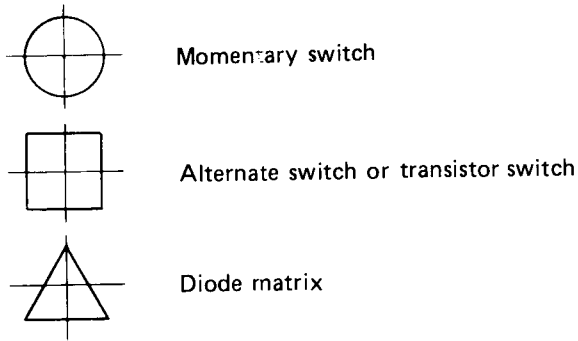

1.4 DESCRIPTION OF KEY MATRIX

1.4.1 INITIALIZATION DIODE MATRIX

There are six types of initial set diode matrixes. These are read only when the power is first supplied to V_{DD} (Power ON Reset) and the CE pin level changes from low to high (CE Reset). In other cases, the states of diode matrixes are ignored.

- (1) Area (USA, Oceania, Europe) setting switches
AREA1, AREA2
- (2) FM IF offset value setting switches
IF1, IF2
- (3) Control key selector switches
KEY1, KEY2
- (4) Preset key use method (random or sequential access method) selector switch
ACCESS
- (5) Switch for selecting normal or reverse indication in TAPE mode
TAPE
RUN
- (6) Switch for selecting rotary switch for manual tuning
ROTARY

For these settings, connect (1) or open (0) the intersections on matrixes with diodes.

SYMBOL	DESCRIPTION																																								
AREA1 AREA2	<p>Select an area.</p> <table border="1" data-bbox="379 271 855 488"> <thead> <tr> <th>AREA1</th> <th>AREA2</th> <th>AREA</th> </tr> </thead> <tbody> <tr> <td>0</td> <td>0</td> <td>USA</td> </tr> <tr> <td>0</td> <td>1</td> <td>Oceania</td> </tr> <tr> <td>1</td> <td>0</td> <td>Europe</td> </tr> <tr> <td>1</td> <td>1</td> <td>_____ *</td> </tr> </tbody> </table> <p>* This setting is inhibited.</p>	AREA1	AREA2	AREA	0	0	USA	0	1	Oceania	1	0	Europe	1	1	_____ *																									
AREA1	AREA2	AREA																																							
0	0	USA																																							
0	1	Oceania																																							
1	0	Europe																																							
1	1	_____ *																																							
IF1 IF2	<p>Sets an FM IF offset value. Four intermediate frequencies can be set without changing the displayed frequency.</p> <table border="1" data-bbox="379 650 963 872"> <thead> <tr> <th>IF1</th> <th>IF2</th> <th>INTERMEDIATE FREQUENCY</th> </tr> </thead> <tbody> <tr> <td>0</td> <td>0</td> <td>10.700 MHz</td> </tr> <tr> <td>0</td> <td>1</td> <td>10.725</td> </tr> <tr> <td>1</td> <td>0</td> <td>10.675</td> </tr> <tr> <td>1</td> <td>1</td> <td>10.650</td> </tr> </tbody> </table>	IF1	IF2	INTERMEDIATE FREQUENCY	0	0	10.700 MHz	0	1	10.725	1	0	10.675	1	1	10.650																									
IF1	IF2	INTERMEDIATE FREQUENCY																																							
0	0	10.700 MHz																																							
0	1	10.725																																							
1	0	10.675																																							
1	1	10.650																																							
KEY1 KEY2	<p>Selects control keys with momentary switches.</p> <table border="1" data-bbox="379 944 1155 1166"> <thead> <tr> <th>KEY1</th> <th>KEY2</th> <th>LOCAL</th> <th>FMUTE</th> <th>MONO</th> <th>METAL</th> <th>DolbyNR</th> <th>MSS</th> </tr> </thead> <tbody> <tr> <td>0</td> <td>0</td> <td>○</td> <td>X</td> <td>X</td> <td>X</td> <td>○</td> <td>○</td> </tr> <tr> <td>0</td> <td>1</td> <td>○</td> <td>○</td> <td>○</td> <td>○</td> <td>X</td> <td>X</td> </tr> <tr> <td>1</td> <td>0</td> <td>○</td> <td>○</td> <td>X</td> <td>○</td> <td>○</td> <td>○</td> </tr> <tr> <td>1</td> <td>1</td> <td>○</td> <td>○</td> <td>○</td> <td>○</td> <td>○</td> <td>○</td> </tr> </tbody> </table> <p>○ ... Effective X ... Not effective</p>	KEY1	KEY2	LOCAL	FMUTE	MONO	METAL	DolbyNR	MSS	0	0	○	X	X	X	○	○	0	1	○	○	○	○	X	X	1	0	○	○	X	○	○	○	1	1	○	○	○	○	○	○
KEY1	KEY2	LOCAL	FMUTE	MONO	METAL	DolbyNR	MSS																																		
0	0	○	X	X	X	○	○																																		
0	1	○	○	○	○	X	X																																		
1	0	○	○	X	○	○	○																																		
1	1	○	○	○	○	○	○																																		
ACCESS	<p>Determines whether the preset keys are to be used in the random or sequential access mode.</p> <p>0 ... Keys M1 to M6 are used in the random access mode. 1 ... Key M1 is used in the sequential access mode.</p>																																								
TAPE RUN	<p>Selects normal or reverse indication in the TAPE mode.</p> <p>0 ... Display 1 ... No display</p>																																								
ROTARY	<p>Determines whether the rotary switches are to be used for MU and MD in the manual tuning mode.</p> <p>0 ... Push buttons are used. 1 ... A rotary switch is used. The time for preventing Manual Up/Manual Down chattering is reduced and response to high speed pulses is enabled.</p>																																								

1.4.2 ALTERNATE SWITCHES

Unlike initial set switches, these switches can be operated at any time.

SYMBOL	DESCRIPTION															
POWER	Set to 1 when the main switch is set to ON and V_{DD} , CE pins are set to high level. 0 . . . Time is displayed unconditionally. 1 . . . Ordinary radio or tape recorder operation is performed. Attention to condition of RADIO switch.															
RADIO	Effective only when the POWER switch is ON and selects either the RADIO or TAPE mode. <table border="1" data-bbox="347 507 853 729"> <thead> <tr> <th>POWER</th> <th>RADIO</th> <th></th> </tr> </thead> <tbody> <tr> <td>0</td> <td>0</td> <td>Clock display</td> </tr> <tr> <td>0</td> <td>1</td> <td>Inhibition</td> </tr> <tr> <td>1</td> <td>0</td> <td>TAPE mode *</td> </tr> <tr> <td>1</td> <td>1</td> <td>RADIO mode</td> </tr> </tbody> </table> <p style="text-align: center;">(V_{DD}, CE = High)</p> <p>TAPE mode Time is displayed. Keys related to tape recorder and time adjustment are effective. * PLL is operated in TAPE mode when selected Europe station.</p> <p>RADIO mode Display is made according to priority. The display can be reversed for 8 seconds with the RECALL key.</p>	POWER	RADIO		0	0	Clock display	0	1	Inhibition	1	0	TAPE mode *	1	1	RADIO mode
POWER	RADIO															
0	0	Clock display														
0	1	Inhibition														
1	0	TAPE mode *														
1	1	RADIO mode														
STEREO	Used as the input to the stereo indicator in the RADIO mode and input for normal/reverse display in the TAPE mode. <table border="1" data-bbox="352 1141 853 1342"> <thead> <tr> <th rowspan="2">STEREO</th> <th colspan="2">RADIO</th> </tr> <tr> <th>1</th> <th>0</th> </tr> </thead> <tbody> <tr> <td>0</td> <td>Stereo display OFF</td> <td>Normal display ON</td> </tr> <tr> <td>1</td> <td>Stereo display ON</td> <td>Reverse display ON</td> </tr> </tbody> </table>	STEREO	RADIO		1	0	0	Stereo display OFF	Normal display ON	1	Stereo display ON	Reverse display ON				
STEREO	RADIO															
	1	0														
0	Stereo display OFF	Normal display ON														
1	Stereo display ON	Reverse display ON														

SYMBOL	FUNCTION
SD	<p>Input to the station detector during seek or scanning. For the FM band in Europe, this switch must be set to 1 within approximately 35 ms after PLL is locked. For other areas, it must be set to 1 within approximately 70 ms. When SD is set to 1, seek or scanning stops; if it is not set to 1 approximately 300 ms later, seek or scanning restarts.</p> <p>○ Station is found</p> <p>○ Station not found (noise)</p>

1.4.3 MOMENTARY SWITCHES AND FUNCTIONS

There are 17 momentary switches

SYMBOL	FUNCTION
<div style="border: 1px solid black; padding: 2px; width: fit-content; margin-bottom: 10px;">MANUAL UP</div> <div style="border: 1px solid black; padding: 2px; width: fit-content;">MANUAL DOWN</div>	<p>Keys for manual tuning. A momentary or rotary pulse generation switch can be used. When ROTARY key is set to OFF, a momentary switch can be used. When ROTARY key is set to ON, a rotary switch can be used.</p> <ul style="list-style-type: none"> ○ Momentary switch When this switch is pressed once, frequency goes up (Manual Up) or down (Manual Down) by one step. If this switch is pressed for 0.5 second or longer, the frequency changes quickly until the switch is released. The clock can be adjusted by pressing this switch while pressing the MEMORY ENABLE switch. <ul style="list-style-type: none"> MEMORY ENABLE MANUAL UP Minute adjustment MEMORY ENABLE MANUAL DOWN Hour adjustment ○ Rotary switch Every time this switch is set to ON, frequency goes up (MU) or down (MD) by one step. Quick tuning is not performed if this switch is pressed for 0.5 second or longer. Note: In case of selecting rotary switch, MUTE is not output in operating UP/DOWN.
<div style="border: 1px solid black; padding: 2px; width: fit-content;">MEMORY ENABLE</div>	<p>This key is used when frequencies are written in memories, the clock is adjusted together with a MANUAL UP or MANUAL DOWN key, or the prior mode is switched together with the RECAL key.</p> <ul style="list-style-type: none"> ○ For frequency display When this key is released, the channel display blinks for 8 seconds at 0.5 second intervals. If a key, M1 to M6, is pressed during blinking, the displayed frequency is written into the corresponding memory, then blinking stops. If no key is pressed within 8 seconds, the channel display continues to blink; blinking stops 8 seconds later and write is inhibited. ○ For clock display Hour and minute can be adjusted by pressing the MU and MD keys while the channel display is blinking. When ROT is set to OFF, quick adjustment is enabled by pressing this switch for 0.5 second or longer. In the RADIO mode, the channel display stops blinking when this key is pressed together with the RECALL key; the prior mode is reversed.

SYMBOL	FUNCTION
<p>SEEK</p>	<p>Automatic tuning keys. (Sawtooth wave mode)</p> <p>Automatic tuning stops when the SD matrix is set on. A direction of UP/DOWN is followed by pushed MANUAL UP or MANUAL DOWN before. Automatic tuning does not stop if the following keys are pressed:</p> <p style="text-align: center;"> MEMORY ENABLE RECALL LOUD MONO-MSS LOCAL-METAL FMUTE DolbyNR </p> <p>See the explanation of the SD matrix for details.</p>
<p>SCAN</p>	<p>Automatic tuning stops when the SD matrix is set on and the frequency is held for approximately 8 seconds. If the SCAN key is not pressed within 8 seconds, automatic tuning restarts. If SCAN key is pressed again in searching, automatic tuning stops and the frequency is held. Other operations are the same as those of the SEEK key.</p>
<p>RECAL</p>	<p>In the RADIO mode, the clock and frequency displays are reversed. The display not in the prior mode is displayed for 8 seconds, then the prior mode is reset. When this key is pressed together with the MEMORY ENABLE key, the prior mode can be reversed.</p>
<p>M1 to M6</p>	<p>Keys for calling or writing preset memories.</p> <p>Keys M1 to M6 are used in the random access mode. Only key M1 is used in the sequential access mode.</p> <p>When SM is set to OFF, a random access mode is selected. When it is set to ON, a sequential access mode is selected. When power is first supplied to V_{DD} the contents of M1 of FM are accessed.</p> <ul style="list-style-type: none"> ○ Random access mode <p>Keys M1 to M6 are used. Each key corresponds to independent memories for FM, MW, and LW. When a key is pressed, the frequency memorized in the corresponding memory is called. If one of keys M1 to M6 is pressed within 8 seconds (the channel indication is blinking) after the MEMORY ENABLE key is pressed during frequency display, the displayed frequency is written in the corresponding memory.</p> ○ Sequential access mode <p>Only key M1 is used. There are six memories for each band (FM, MW, and LW). When key M1 is pressed, the station following the number displayed last at the preset station display position is called. If the MEMORY ENABLE key is pressed during frequency display, the channel display starts blinking; select a station with a MANUAL UP, MANUAL DOWN, SEEK UP, or SEEK DOWN key. When key M1 is released, the number at the preset station display position is incremented by 1 (number 6 is followed by number 1, sawtooth mode). Accordingly, the displayed frequency is assigned to the displayed preset station number.</p>
<p>BAND</p>	<p>Band selector key.</p> <p>The next band is selected every time this key is pressed. Europe: \rightarrowFM \rightarrowMW \rightarrowLW \leftarrow Others: \leftarrowFM \rightarrowMW \leftarrow</p> <p>When a new band is selected, output pins BAND0 and FMUTE-Dolby NR & BAND1 and displays of FM, MW, and FMUTE-LW are reversed. (See the explanation of FMUTE-Dolby NR & BAND1 for details on output pins.</p>

SYMBOL	FUNCTION
<div style="border: 1px solid black; padding: 2px; display: inline-block;">LOUD</div>	<p>LOUDNESS selector key</p> <p>When this key is pressed, output pin LOUD and the LOUD display are reversed.</p> <p>This key can be used as a general purpose key for both the RADIO and TAPE modes. When power is first supplied to V_{DD} output pin LOUD is set to low level and the LOUD display is initialized to the off state.</p>
<div style="border: 1px solid black; padding: 2px; display: inline-block;">MONO- MSS</div>	<p>The RADIO and TAPE modes are independent. This key can be inactivated with alternate switches KEY1 and KEY2.</p> <ul style="list-style-type: none"> ○ RADIO mode <p>This key is used as a MONO/STEREO selector key only when FM is selected. Output pin MONO/STEREO-MSS and the MSS display are reversed every time this key is pressed.</p> ○ TAPE mode <p>This key is used as an MSS selector key.</p> <p>Output pin MONO/STEREO-MSS and the MSS display are reversed every time this key is pressed.</p> <p>In both the RADIO and TAPE modes, output pin MONO/STEREO-MSS is set to low level and each mode display is set in the initial state (OFF) when power is first supplied to V_{DD}.</p>
<div style="border: 1px solid black; padding: 2px; display: inline-block;">LOCAL- METAL</div>	<p>The RADIO and TAPE modes are independent. Only the METAL position can be deactivated with alternate switches KEY1 and KEY2.</p> <ul style="list-style-type: none"> ○ RADIO mode <p>This key is used as an LO/DX selector key.</p> <p>Output pin LO/DX-METAL and the LOCAL display are reversed every time this key is pressed.</p> ○ TAPE mode <p>This key is used as a METAL selector key.</p> <p>Output pin LO/DX-METAL and the METAL display are reversed every time this key is pressed.</p> <p>In both the RADIO AND TAPE modes, output pin LO/DX-METAL is set to low level and each mode display is set to the initial state (OFF).</p>
<div style="border: 1px solid black; padding: 2px; display: inline-block;">FMUTE- Dolby NR</div>	<p>The RADIO and TAPE modes operate independently. When European bands are selected, this key is not effective. This key can be deactivated with alternate switches KEY1 and KEY2.</p> <ul style="list-style-type: none"> ○ RADIO mode <p>This key is used as an FM MUTE key which is effective only in the FM mode.</p> <p>Output pin FMUTE-Dolby NR and the MUTE display are reversed every time this key is pressed.</p> <p>Output pin FMUTE-Dolby NR is set to low level and the MUTE display is set to the initial state (OFF) when power is first supplied to V_{DD}.</p> ○ TAPE mode <p>This key is used as a Dolby NR selector key.</p> <p>Output pin FMUTE-Dolby NR and the Dolby NR display are reversed every time this key is pressed.</p> <p>Output pin FMUTE-Dolby NR is set to high level and the Dolby NR display is set to the initial state (OFF) when power is first supplied to V_{DD}.</p>

Key Scan Timing Chart

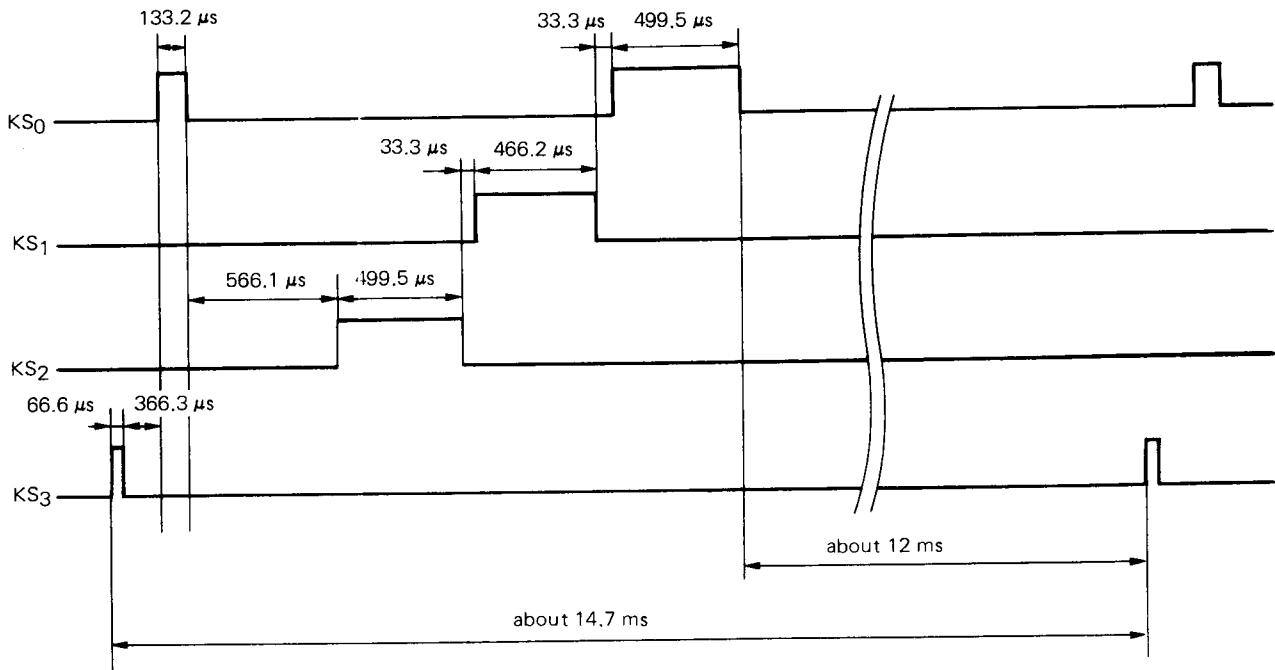

Preset Memory Initial Setting

(1) When power is first supplied, preset memories M1 to M6 are set as follows:

BAND	Memory		M1	M2	M3	M4	M5	M6	Unit
	Area								
FM	Europe		87.5	98.1	108.0	93.1	95.7	107.7	MHz
	USA		87.5	98.1	107.9	93.1	95.7	107.7	
	Oceania		87.5	98.1	108.0	93.1	95.7	107.7	
MW	Europe		522	612	999	1404	1620	810	KHz
	USA		530	610	1000	1400	1620	810	
	Oceania		522	612	999	1404	1620	810	
LW	Europe		146	155	200	218	290	254	

(2) In case of RADIO mode, receiving band is FM band, and called a minimum frequency in FM band.

(3) The clock is one a.m.

When CE terminal is set to high and V_{DD} is not OFF, preset memories are as follows:

(1) Data of preset station memories M1 to M6 and last station memories are what is written before CE terminal is set from high to low.

(2) In case of RADIO mode, condition of memory is what is before CE terminal is set to low from high.

2. DISPLAY

2.1 DISPLAY CONNECTION

- LCD Pattern for USA and Oceania

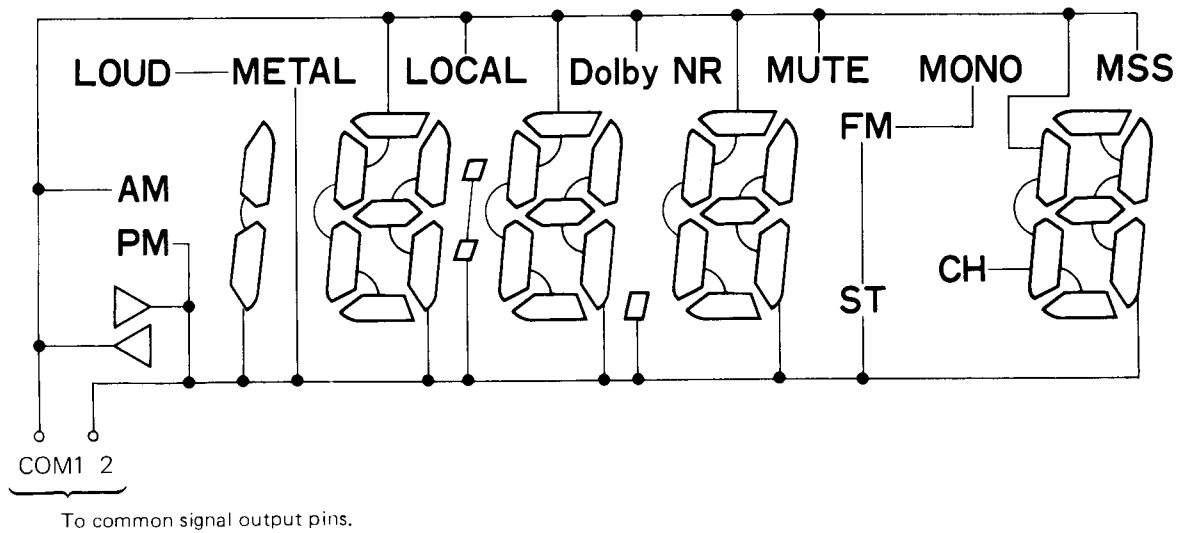
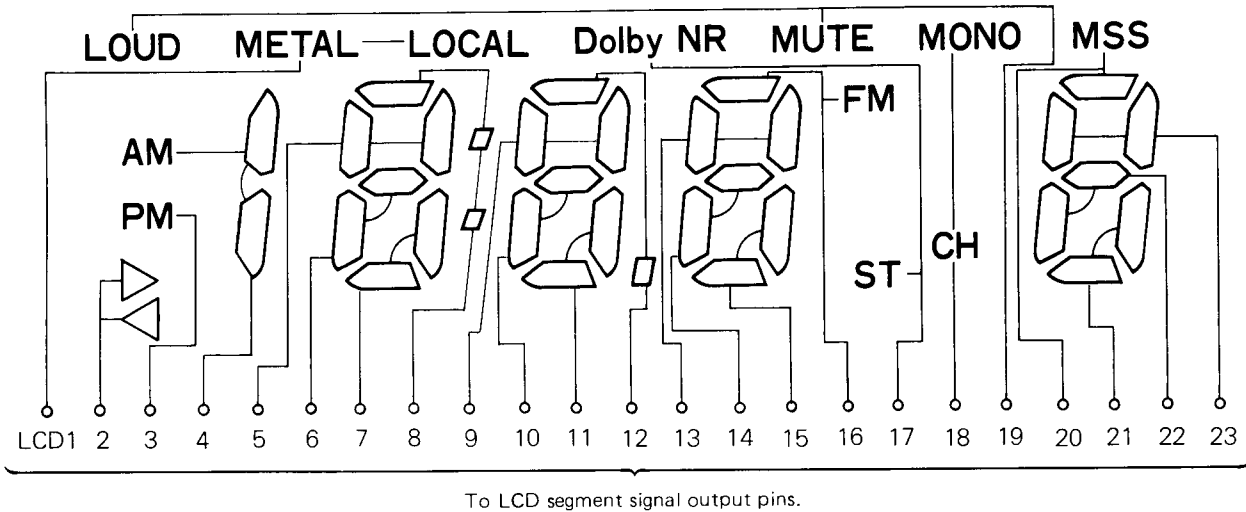

○ LCD Pattern for Europe

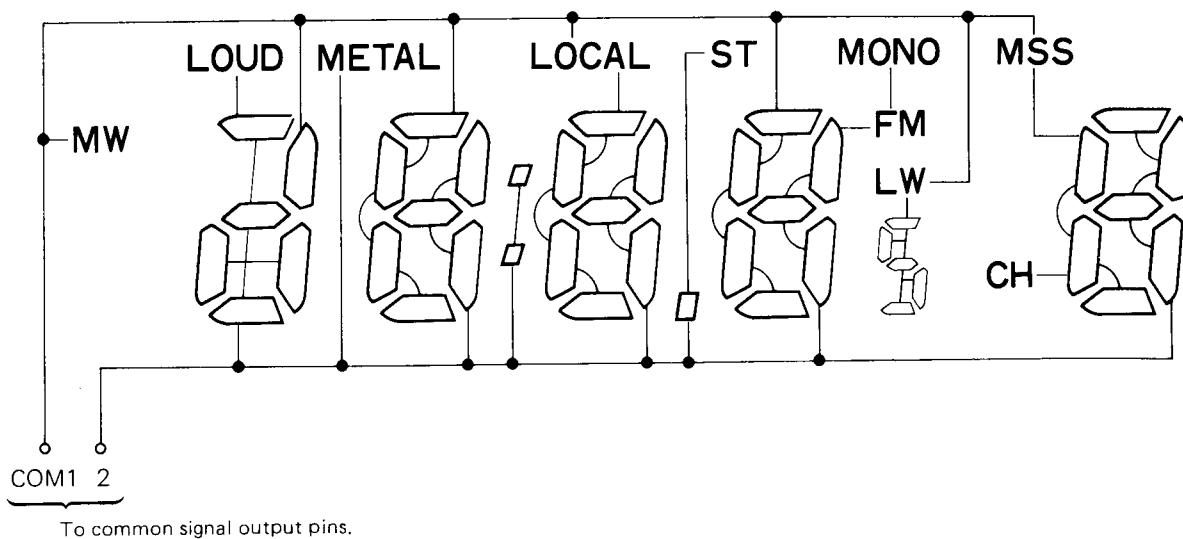
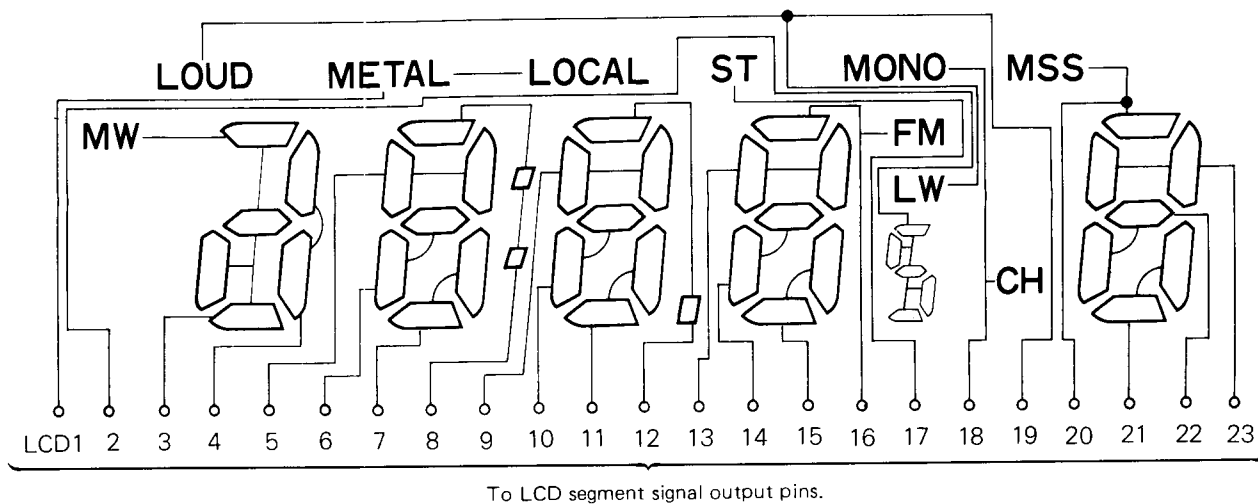

2.2 DISPLAY TYPE

1 2 3 4 5 6 7 8 9 0

2.3 DESCRIPTION OF DISPLAY

DISPLAY	EXPLANATION
FM FM AM MW LW	Band display. The display which corresponds to the currently received band lights up only in the frequency display mode.
AM PM	A.M./P.M. indication for 12 hour clock. This display is in USA and Oceania, but in Europe is 24-hour clock.
MONO	MONO/ <u>STEREO</u> display when receiving FM band. This display lights up only in the FM band frequency display mode.
CH8	Lights up during preset memory display. It remains lighted when the preset memory is read or written, and when receiving frequency corresponds with the frequency. Also, it blinks at 1 Hz intervals for 8 seconds when the preset memory can be written.
LOUD	Lights up and turns out the light when LOUD key is pushed every a time.
MUTE	Lights up when FMUTE terminal is high level.
METAL Dolby NR MSS	Lights up and turns out the light in TAPE mode when each key is pushed every a time. Lights up when each output terminal is high level.

2.4 LCD DRIVE SIGNAL

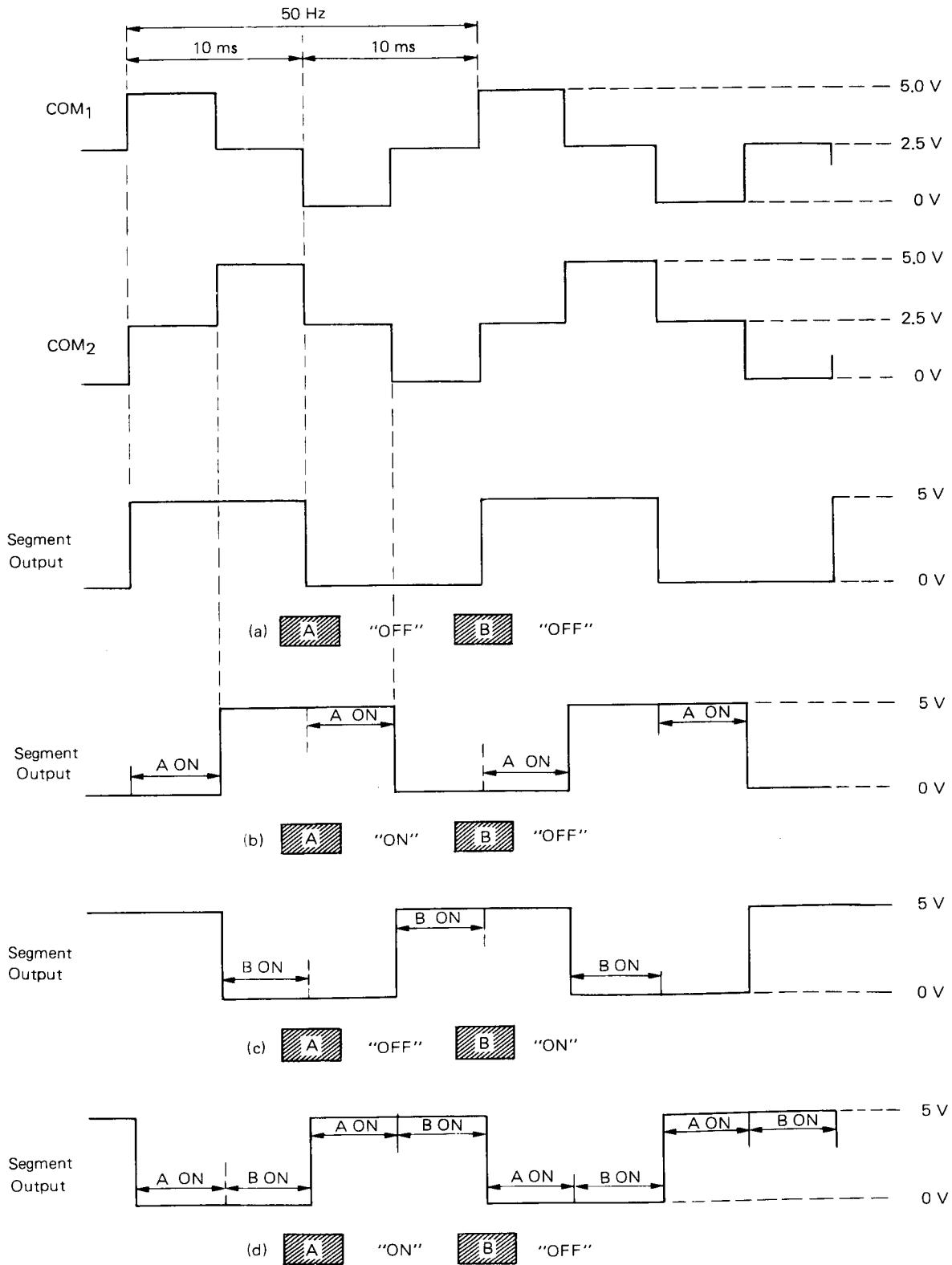
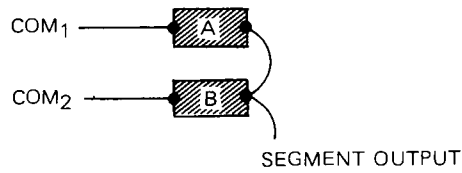

3. TIMING CHART (MUTE OUTPUT (ACTIVE-HIGH) TIMING CHART)

- ① Key on chattering prevention time
- ② MUTE leading time
- ③ Frequency division ratio setting and display contents change time
- ④ MUTE trailing time
- ⑤ Wait time until SD detection
- ⑥ Wait time until SD check
- ⑦ Wait time until PLL locking (depends on the externally connected LPF constant)

(1) Manual Up/Down

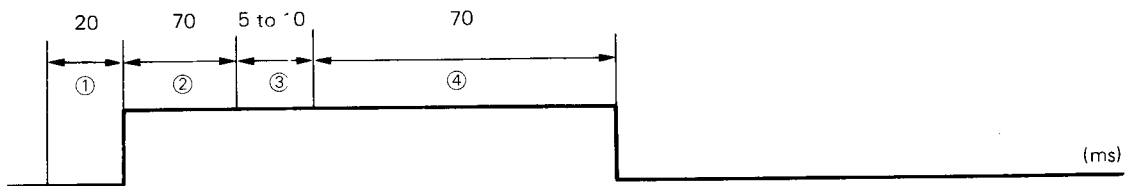

Band edge

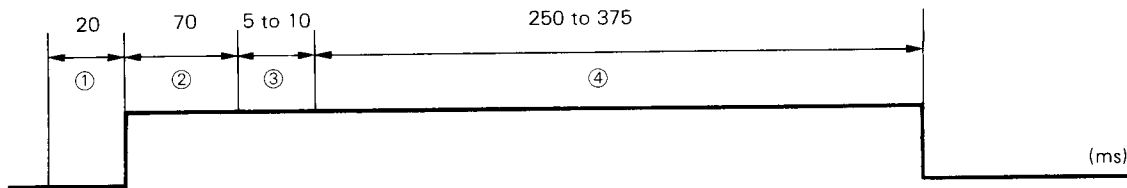

(2) Seek Up

Station found

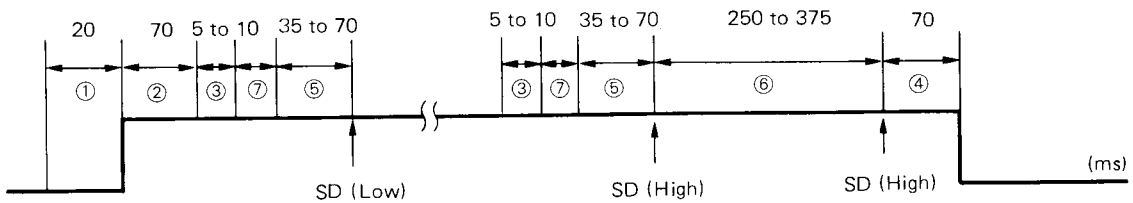

Noise

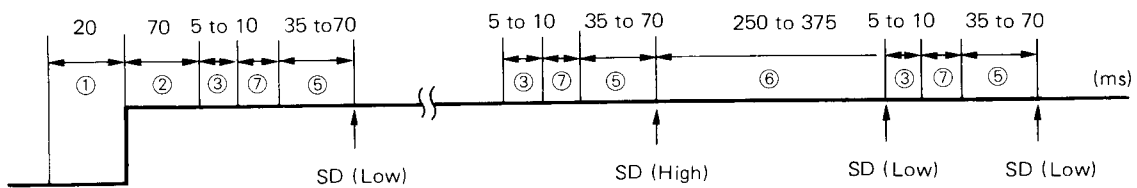

(3) Scan up

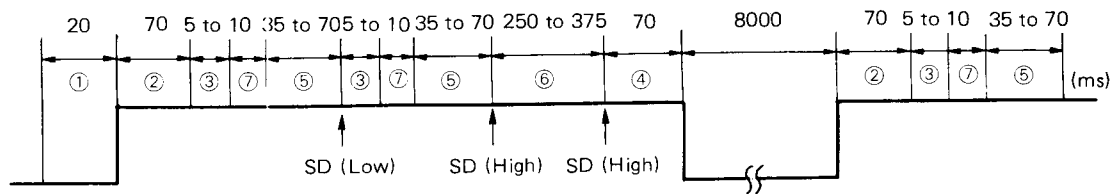

Same as seek when noise is detected.

Band edge

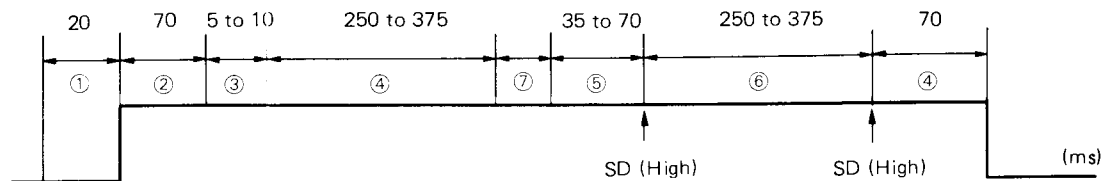

(4) When preset memory is called

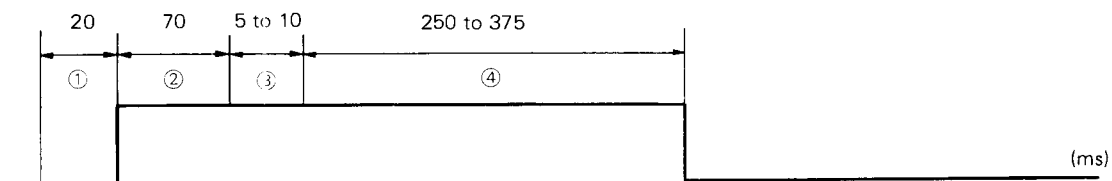

(5) When reception band is switched

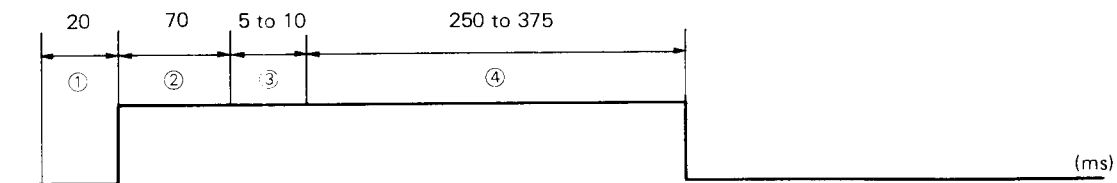

(6) When RADIO mode changes (Low → High, High → Low)

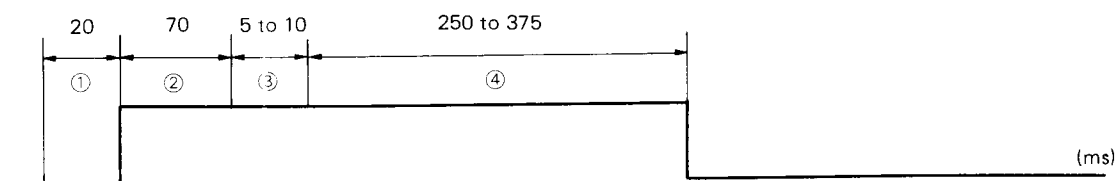

(7) When POWER switch changes from low to high level

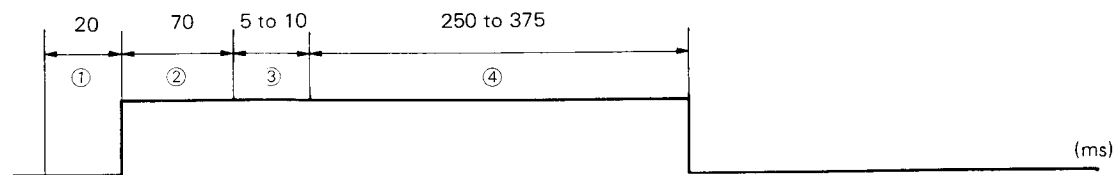

4. APPLICATION CIRCUIT

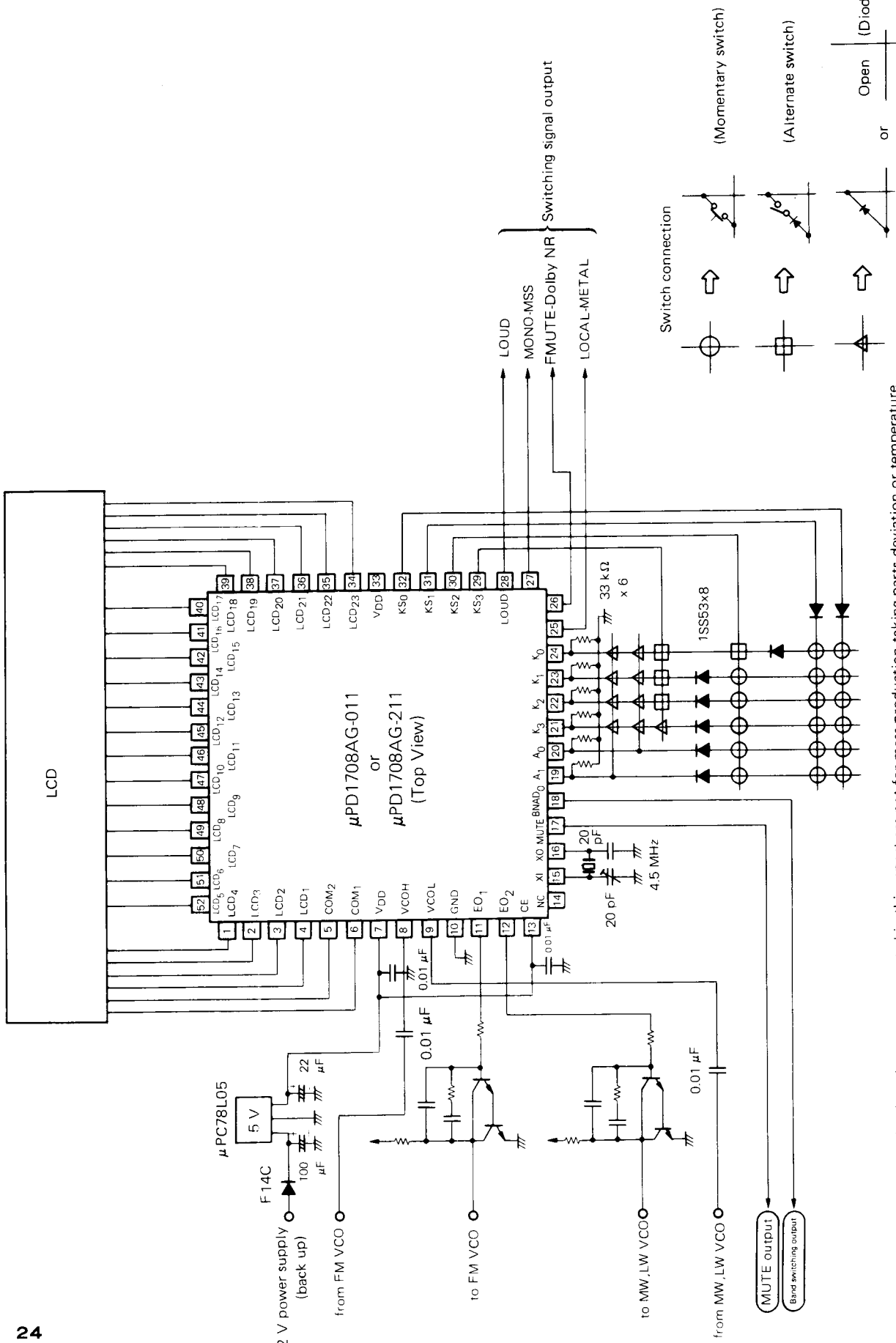

The application circuit and constant presented in this report are not for mass production taking parts deviation or temperature characteristics into consideration. For patent regarding the circuits in this report, NEC does not bear any responsibility.

5. ELECTRICAL CHARACTERISTICS

5.1 ABSOLUTE MAXIMUM RATINGS

Power Supply Voltage	V_{DD}	-0.3 to +6.0	V
Input Voltage	V_I	-0.3 to + V_{DD} +0.3	V
Output Voltage	V_O	-0.3 to + V_{DD} + 0.3	V
Output Absorption Current	I_O	10	mA
Ambient Temperature	T_a	-40 to + 85	°C
Storage Temperature	T_{stg}	-55 to + 125	°C

5.2 RECOMMENDED OPERATING CONDITIONS

CHARACTERISTIC	SYMBOL	MIN.	TYP.	MAX.	UNIT	CONDITION
Power Supply Voltage	V_{DD}	4.5	5.0	5.5	V	
Ambient Temperature	T_a	-40		+85	°C	
Input Oscillation	V_{in}	0.3		4.5	Vp-p	VCOL (AM) terminal
Input Oscillation	V_{in}	0.5		4.5	Vp-p	VCOH (FM) terminal

5.3 DC CHARACTERISTICS ($V_{DD} = +4.5$ to $+5.5$ V, $T_a = -40$ to $+85$ °C)

CHARACTERISTIC	SYMBOL	MIN.	TYP.	MAX.	UNIT	CONDITION
Power Supply Voltage	V_{DD1}	4.5	5.0	5.5	V	CPU and PLL operation
Power Supply Voltage	V_{DD2}	3.5		5.5	V	CPU operation only
Power Supply Current	I_{DD1}		15		mA	VCOH(FM) terminal (When 120 MHz is input)
Power Supply Current	I_{DD2}		400		μA	Clock operation only
Data Retention Voltage	V_{DR}	2.5		V_{DD}	V	When clock oscillation is stopped
Data Retention Current	I_{DR}		1	10	μA	When clock oscillation is stopped $V_{DD}=5$ V
High Level Output Current	I_{OH1}	-1.0	-2.5		mA	PORT A,B,C,EO ₁ ,EO ₂ terminals $V_{OH}=V_{DD}-1$ V
High Level Output Current	I_{OH2}	-10	-18		μA	LCD ₁ to LCD ₂₃ terminals $V_{OH}=V_{DD}-1$ V
High Level Output Current	I_{OH3}	-20	-60		μA	COM ₁ , COM ₂ terminals $V_{OH}=V_{DD}-1$ V
Low Level Output Current	I_{OL1}	1.0	3.8		mA	PORT A,C ₁ ,C ₀ ,EO ₁ , EO ₂ terminals $V_{OL}=1$ V
Low Level Output Current	I_{OL2}	25	100		μA	PORT B,C ₂ , C ₃ $V_{OL}=1$ V
Low Level Output Current	I_{OL3}	10	30		μA	LCD ₁ to LCD ₂₃ terminals $V_{OL}=1$ V
Low Level Output Current	I_{OL4}	20	80		μA	COM ₁ ,COM ₂ terminals $V_{OL}=1$ V
High Level Input Current	I_{IH1}	10	35	60	μA	K ₀ to K ₃ terminals $V_{IH}=V_{DD}=5$ V
High Level Input Current	I_{IH2}	100	300		μA	VCOH, VCOL, X1 terminals $V_{IH}=V_{DD}=5$ V
Output Leak Current	I_L			±1	μA	EO ₁ , EO ₂ terminals
High Level Input Voltage	V_{IH1}	0.7 V_{DD}			V	PA ₀ to PA ₃ terminals
High Level Input Voltage	V_{IH2}	0.6 V_{DD}			V	K ₀ to K ₃ terminals
High Level Input Voltage	V_{IH3}	0.8 V_{DD}			V	CE terminals
Low Level Input Voltage	V_{IL1}			0.3 V_{DD}	V	PA ₀ to PA ₃ terminals
Low Level Input Voltage	V_{IL2}			0.2 V_{DD}	V	K ₀ to K ₃ terminals
Low Level Input Voltage	V_{IL3}			0.2 V_{DD}	V	CE terminals
Output Level	V_O	2.3		2.8	V	COM ₁ ,COM ₂ terminals 1/2 bias voltage $V_{DD}=5$ V

5.4 AC CHARACTERISTICS ($V_{DD} = +4.5$ to $+5.5$ V, $T_a = -40$ to $+85$ °C)

CHARACTERISTIC	SYMBOL	MIN.	TYP.	MAX.	UNIT	CONDITION
Operating Frequency	f_{AML}	0.59		20	MHz	VCOL(AM) terminals $V_i=0.1 V_{p-p}, V_{DD}=4.5$ V
Operating Frequency	f_{FM-1}	10		130	MHz	VCOH(FM) terminals, $V_i=0.3 V_{p-p}, V_{DD}=4.5$ V
Operating Frequency	f_{FM-2}	10		150	MHz	VCOH(FM) terminals, $V_i=0.5 V_{p-p}, V_{DD}=4.5$ V

6. PACKAGE DIMENSIONS (Unit: mm)

μPD1708AG-011-00

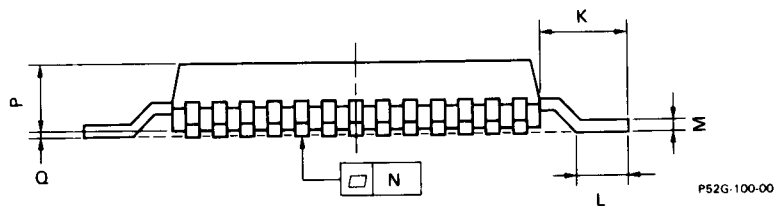
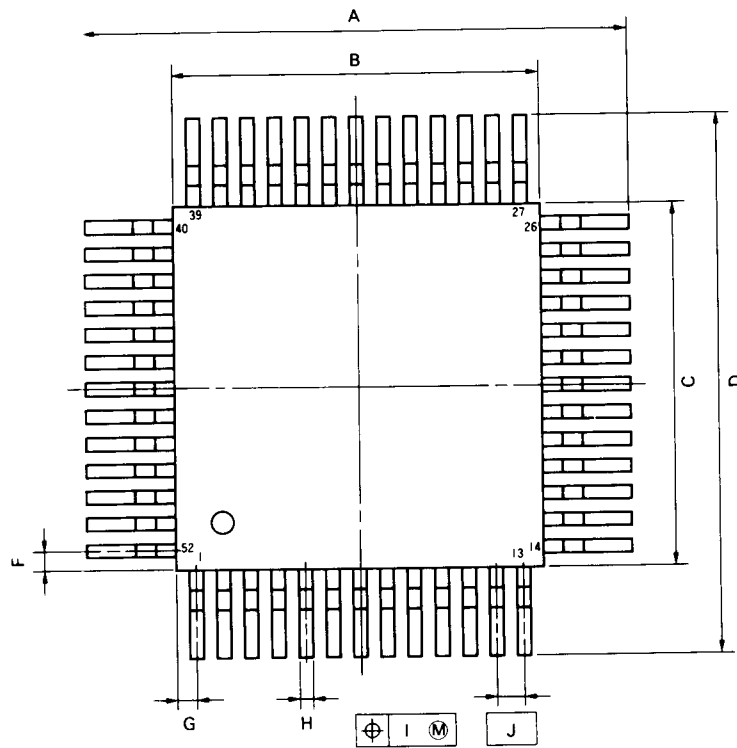

NOTE
Each lead centerline is located within 0.20 mm (0.008 inch) of its true position (T.P.) at maximum material condition.

ITEM	MILLIMETERS	INCHES
A	21.0 ^{-0.4}	0.827 ^{+0.016}
B	14 ^{-0.2}	0.551 ^{-0.008}
C	14 ^{-0.2}	0.551 ^{-0.008}
D	21.0 ^{-0.4}	0.827 ^{+0.016}
F	1.0	0.039
G	1.0	0.039
H	0.40 ^{-0.10}	0.016 ^{-0.004}
I	0.20	0.008
J	1.0 (T.P.)	0.039 (T.P.)
K	3.5 ^{-0.2}	0.138 ^{-0.008}
L	2.2 ^{-0.2}	0.087 ^{-0.008}
M	0.15 ^{-0.10}	0.006 ^{-0.004}
N	0.15	0.006
P	2.6 ^{-0.2}	0.102 ^{-0.004}
Q	0.1 ^{-0.1}	0.004 ^{-0.004}

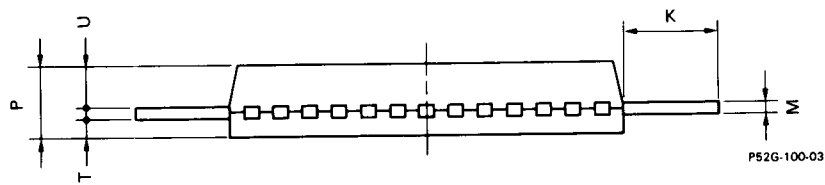
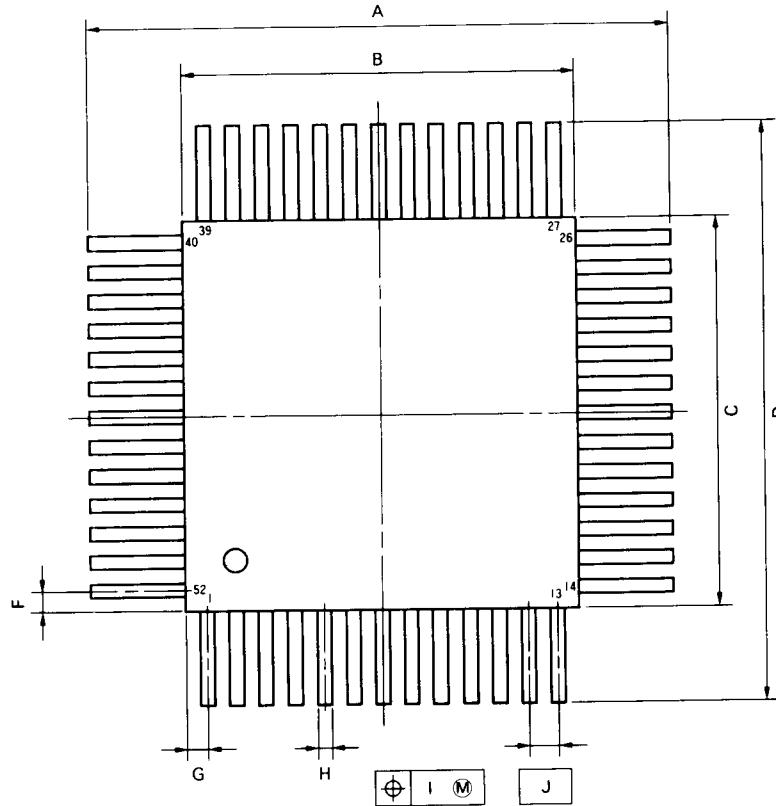

NOTE
 Each lead centerline is located within 0.20 mm (0.008 inch) of its true position (T.P.) at maximum material condition.

ITEM	MILLIMETERS	INCHES
A	19.8 ^{+0.4}	0.780 ^{+0.016}
B	14 ^{-0.2}	0.551 ^{-0.008}
C	14 ^{-0.2}	0.551 ^{-0.008}
D	19.8 ^{+0.4}	0.780 ^{+0.016}
F	1.0	0.039
G	1.0	0.039
H	0.40 ^{-0.10}	0.016 ^{-0.004}
I	0.20	0.008
J	1.0 (T.P.)	0.039 (T.P.)
K	2.9 ^{-0.2}	0.114 ^{-0.008}
M	0.15 ^{+0.02}	0.006 ^{+0.001}
P	2.6 ^{+0.2}	0.102 ^{+0.008}
T	1.0	0.039
U	1.45	0.057