



PRODUCT SPECIFICATION

Model No : CST-432G/431G

Descriptions:

- 0.4 Inch Triad Digits Display
- CST-432: Common Anode
- CST-431: Common Cathode
- Emitting Color: Yellow Green



CUSTOMER APPROVED SIGNATURES	APPROVED BY	CHECKED BY	PREPARED BY

CHINA SEMICONDUCTOR CORPORATION
Address:2FL. NO.909,Chung-Cheng Road,
Chung-Ho City Taipei Hsien,Taiwan.

Tel:886-2-2223-9696
Fax:886-2-2223-9377

OPTO PLUS TECHNOLOGIES CO.,LTD
Address:696 Shun jiang Rd.,Ji Shan St.Shaoxing,
ZheJiang,China

Tel:86-0575-88623888
Fax:86-0575-88623112



Model No : CST-432/431G

Features -

1. 0.4 inch (10.2mm) digit height.
2. Case mold type.
3. RoHS compliant.
4. Low power consumption.
5. Easy mounting on P.C. board or socket.

Device Selection Guide -

Part No.	Chip		Description
	Material	Emitted Color	
CST-432G	GaP	Yellow Green	Common Anode
CST-431G	GaP	Yellow Green	Common Cathode

Package Dimensions -

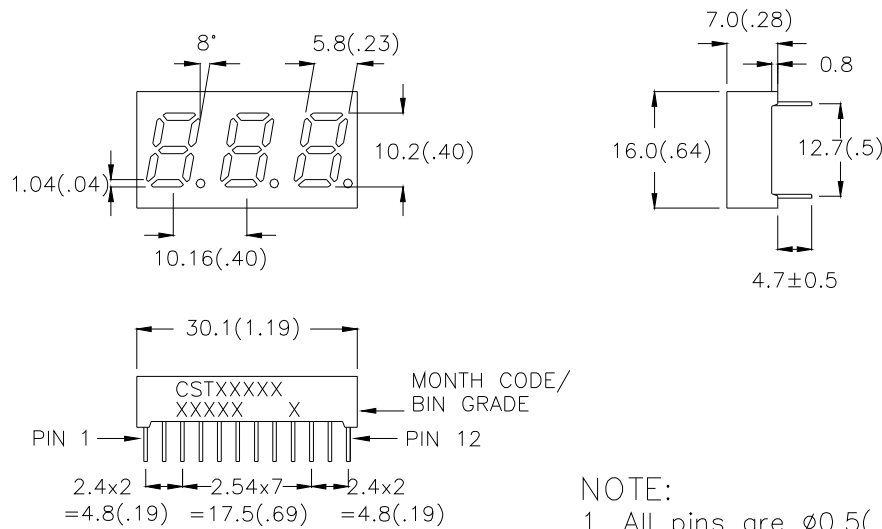

NOTE:

1. All pins are $\phi 0.5$ (.02).
2. Dimension in millimeter (inch), and tolerance is ± 0.25 (.01) unless otherwise noted.



Model No : CST-432/431G

Internal Circuit Diagrams -

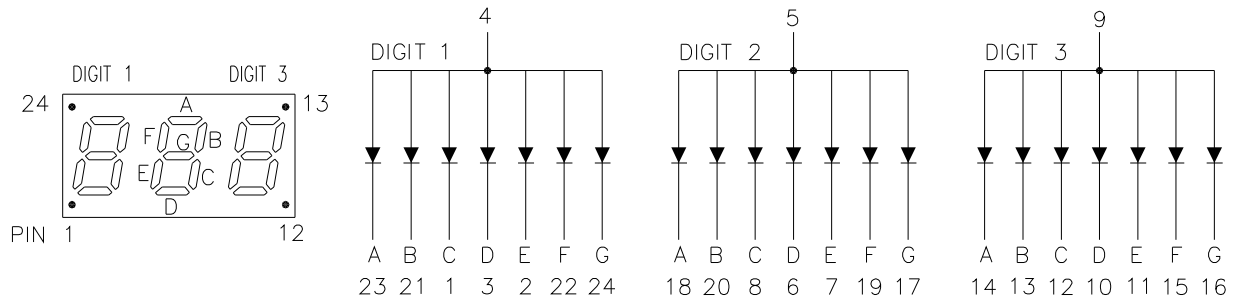

CST-432 Common Anode
(CST-431 Common Cathode)

Absolute Maximum Rating -

(Ta=25°C)

Parameter	Symbol	Rating	Unit
Power Dissipation Per Dice	P_{AD}	70	mW
Continuous Forward Current Per Dice	I_{AF}	25	mA
Peak Current Per Dice(duty cycle 1/10,1KHz)	I_{PF}	90	mA
Derating Linear From 25°C Per Dice	-	0.33	mA/°C
Reverse Voltage Per Dice	V_R	5	V
Operating Temp.	T_{opr}	-35 ~ +85	°C
Storage Temp.	T_{stg}	-35 ~ +85	°C
Solder temperature 1/16 inch below seating plane for 3 seconds at 260°C			



Model No : CST-432/431G

■ Electro-optical Characteristics -

(Ta=25°C)

Parameter	Symbol	Min.	Typ.	Max.	Unit	Condition
Forward Voltage Per Segment	V_F	-	2.1	2.8	V	$I_F=20mA$
Luminous Intensity Per Segment	I_v	-	3.5	-	mcd	$I_F=10mA$
Peak Emission Wavelength	λ_p	-	568	-	nm	$I_F=20mA$
Dominant Wavelength	λ_d	-	572	-	nm	$I_F=20mA$
Spectrum Radiation Bandwidth	$\Delta \lambda$	-	30	-	nm	$I_F=20mA$
Reverse Current	I_R	-	-	100	μA	$V_R=5V$
Luminous Intensity Matching Ratio	I_V-m	-	-	2:1	-	$I_F=10mA$



Model No : CST-432/431G

■ Typical Electrical / Optical Characteristics Curves -

(Ta = 25°C Unless Otherwise Noted)

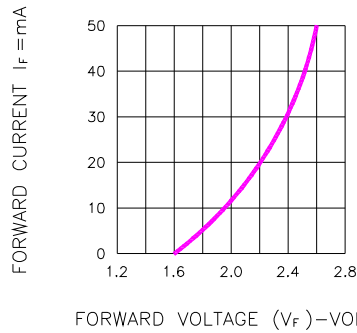

Fig.1 FORWARD CURRENT VS. FORWARD VOLTAGE

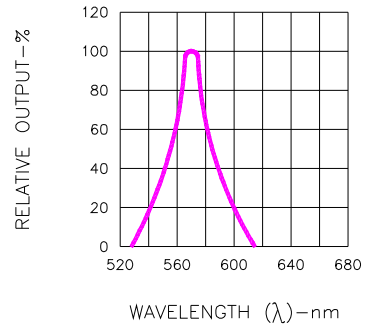

Fig.2 SPECTRAL RESPONSE

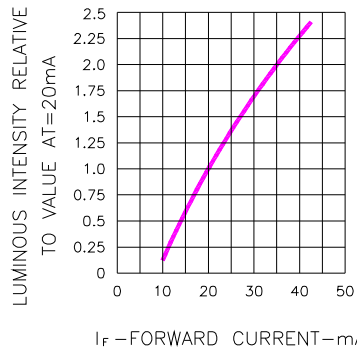

Fig.3 RELATIVE LUMINOUS INTENSITY VS. FORWARD CURRENT

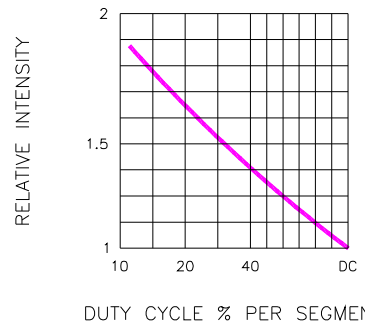

Fig.5 LUMINOUS INTENSITY VS. DUTY CYCLE

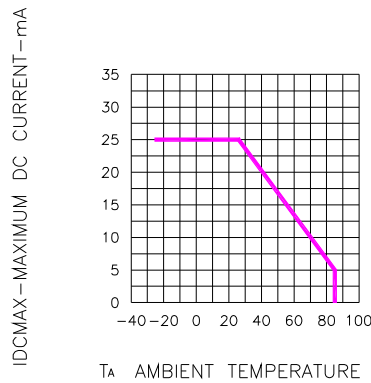

Fig.4 MAXIMUM ALLOWABLE DC CURRENT PER SEGMENT VS. A FUNCTION OF AMBIENT TEMPERATURE

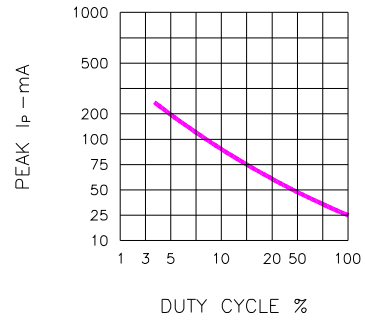

Fig.6 MAX PEAK CURRENT VS. DUTY CYCLE % (REFRESH RATE f=1 KHz)



Spec. No.	PS-ND-08072513
Rev.	A

Model No : CST-432/431G

■ Package Dimensions

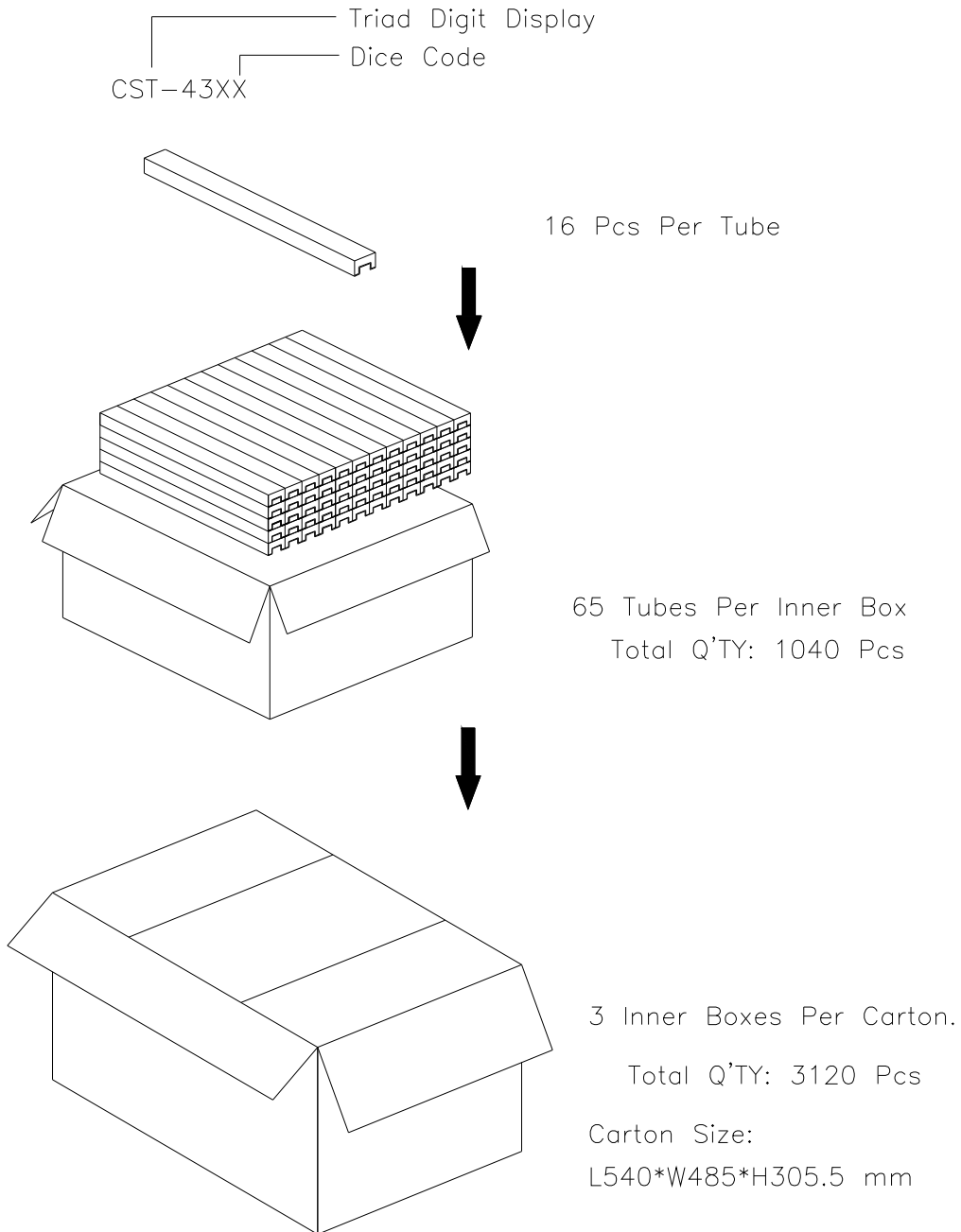

Note: The specifications are subject to change without notice. Please contact us for updated information