

Triple-Channel HDTV Filters

General Description

www.datasheet4u.com

The MAX9500/MAX9501 are fully integrated solutions for filtering and buffering HDTV signals. The MAX9500 operates from a single +5V supply, while the MAX9501 operates from dual $\pm 5V$ supplies. The MAX9500/MAX9501 triple-channel video reconstruction filters are both gain and delay matched and are ideal for use in set-top boxes, DVD players, and other equipment that generate analog HDTV outputs.

The MAX9500/MAX9501 interface between the current-output, digital-to-analog converters (DAC) of an Advanced Television Standard Committee (ATSC), Motion Picture Experts Group (MPEG) decoder and the external connections of a television, set-top box, or DVD player.

The MAX9500/MAX9501 feature a DC-coupled input with very low input capacitance and high resistance. The highly selective lowpass filters remove spectral replicas at the output of the DAC. The output amplifier has +6dB of gain to drive 75Ω back-terminated loads to unity gain. The DC-coupled input eliminates problems such as sync crush, droop, and field tilt. The output load can be DC- or AC-coupled, depending on the application.

All three channels in the MAX9500/MAX9501 have the same frequency response with matched group delay and gain. The MAX9500/MAX9501 filter response meets the requirements of the EIA-770.3/SMPTE274M filter template achieving > 40dB attenuation at 44.25MHz. The MAX9500/MAX9501 can also be used as an anti-aliasing filter for HDTV component inputs.

The MAX9500/MAX9501 are available in 16-pin SO and compact 16-pin QSOP packages, and are fully specified over the -40°C to $+85^{\circ}\text{C}$ extended temperature range.

Applications

- Cable and Satellite Set-Top Box Receivers
- A/V Receivers
- Home Theater Systems
- HDTV Sets
- DVD Players
- Video Projectors
- Digital Displays

Pin Configurations appear at end of data sheet.

Features

- ◆ 30MHz Bandwidth at $\pm 1.5\text{dB}$
- ◆ Extremely Sharp Rolloff, Lowpass Filters -50dB at 44.25MHz
- ◆ DC-Coupled Inputs; AC- or DC-Coupled Outputs
- ◆ $\pm 5\text{V}$ Dual Supply (MAX9501)
- ◆ 5V Single Supply (MAX9500)
- ◆ Matched Group Delay and Gain
- ◆ Drive Single/Double Back-Terminated Loads ($150\Omega/75\Omega$) Directly to Ground
- ◆ Sink and Source Output Current
- ◆ High Input Impedance to Interface to Low Output-Current DAC
- ◆ 16-Pin SO and QSOP Packages

Ordering Information

PART	TEMP RANGE	PIN-PACKAGE	SUPPLY VOLTAGE (V)
MAX9500ESE+*	-40°C to $+85^{\circ}\text{C}$	16 SO	+5
MAX9500EEE+	-40°C to $+85^{\circ}\text{C}$	16 QSOP	+5
MAX9501ESE+*	-40°C to $+85^{\circ}\text{C}$	16 SO	± 5
MAX9501EEE+*	-40°C to $+85^{\circ}\text{C}$	16 QSOP	± 5

+Denotes lead-free package.

*Future product—contact factory for availability.

Typical Operating Circuit

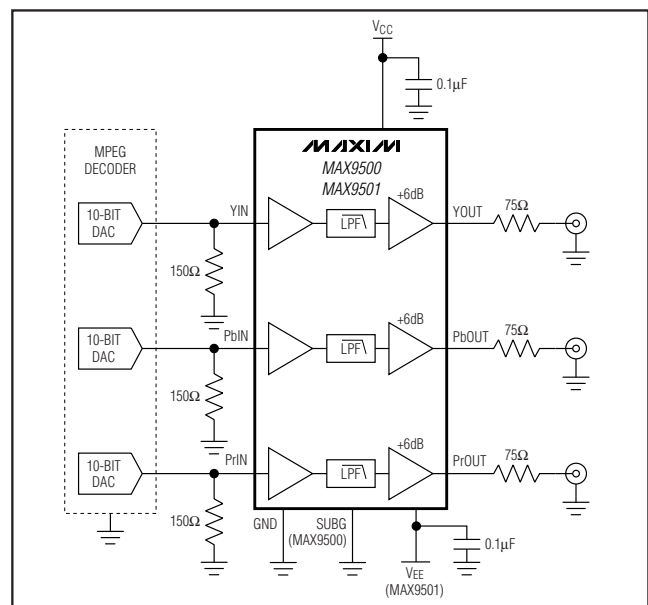

Triple-Channel HDTV Filters

ABSOLUTE MAXIMUM RATINGS

Positive Supply Voltage (V_{CC} to GND)	-0.3V to +6V
Negative Supply Voltage (MAX9501) (V_{EE} to GND)	+0.3V to -6V
All Input Pins	-0.3V to ($V_{CC} + 0.3V$)
All Output Pins (MAX9500)	-0.3V to ($V_{CC} + 0.3V$)
All Output Pins (MAX9501)	($V_{EE} - 0.3V$) to +3V
Output Short-Circuit Duration (OUT to V_{CC} or GND) (MAX9500)	10s
Output Short-Circuit Duration (OUT to GND or V_{EE}) (MAX9501)	10s

Continuous Input Current (Y_{IN} , Pb_{IN} , Pr_{IN})	$\pm 20mA$
Continuous Power Dissipation ($T_A = +70^\circ C$)	
16-Pin SO (derate 13mW/ $^\circ C$ above $+70^\circ C$)	1039mW
16-Pin QSOP (derate 12.8mW/ $^\circ C$ above $+70^\circ C$)	1025mW
Operating Temperature Range	$-40^\circ C$ to $+85^\circ C$
Junction Temperature	$+150^\circ C$
Storage Temperature Range	$-65^\circ C$ to $+150^\circ C$
Lead Temperature (soldering, 10s)	$+300^\circ C$

Stresses beyond those listed under "Absolute Maximum Ratings" may cause permanent damage to the device. These are stress ratings only, and functional operation of the device at these or any other conditions beyond those indicated in the operational sections of the specifications is not implied. Exposure to absolute maximum rating conditions for extended periods may affect device reliability.

ELECTRICAL CHARACTERISTICS—MAX9500 (Single Supply)

($V_{CC} = 5V$, $R_L = \infty$, $T_A = T_{MIN}$ to T_{MAX} , unless otherwise noted. Typical values are at $T_A = +25^\circ C$.) (Note 1)

PARAMETER	SYMBOL	CONDITIONS	MIN	TYP	MAX	UNITS	
DC CHARACTERISTICS							
Supply Voltage Range	V_{CC}	Guaranteed by PSRR	4.5	5.0	5.5	V	
Quiescent Supply Current (Per Channel)	I_{CC}			34	46	mA	
Input Voltage Range	V_{IN}	Guaranteed by voltage gain	0		1.4	V	
Voltage Gain	A_V	$V_{IN} = 0$ to 1.4V	$R_L = 150\Omega$ to GND	+5.5	+6	+6.4	dB
			$R_L = 150\Omega$ to 2V	+5.5	+6	+6.4	
			$R_L = 75\Omega$ to GND	+5.5	+6	+6.4	
			$R_L = 75\Omega$ to 2V	+5.5	+6	+6.4	
Gain Matching	ΔA_V	Any two channels	-0.5	0	+0.5	dB	
Input Bias Current	I_B	$V_{IN} = 0V$		4	10	μA	
Input Resistance	R_{IN}	$V_{IN} = 0$ to 1.4V	250	800		k Ω	
Output Offset Voltage	V_{OS}	$V_{IN} = 0V$	0.65	0.8	1.00	V	
Power-Supply Rejection Ratio	PSRR	$V_{CC} = 4.5V$ to 5.5V, $V_{IN} = 1.4V$	30	60		dB	
AC CHARACTERISTICS ($R_L = 150\Omega$ to GND, unless otherwise noted)							
Passband Flatness	A_{PB}	$f = 0.1MHz$ to 30MHz, $V_{IN} = 1V_{P-P}$, $T_A = +25^\circ C$	± 3.0	± 1.5		dB	
Attenuation	A_{SB}	$f = 44.25MHz$, $V_{IN} = 1V_{P-P}$, $T_A = +25^\circ C$	40	51		dB	
		$f = 74.25MHz$, $V_{IN} = 1V_{P-P}$		38		dB	
Settling Time	t_S	$V_{IN} = 1V_{P-P}$, $V_{OUT} < 1\%$		150		ns	
Slew Rate	SR	$V_{IN} = 1V_{P-P}$		100		V/ μs	
Bar Response	BR	Bar time is one-half the active line of a 1080i format signal; the beginning 2.5% and the ending 2.5% of the bar time is ignored		0.4		K%	

Triple-Channel HDTV Filters

MAX9500/MAX9501

ELECTRICAL CHARACTERISTICS—MAX9500 (Single Supply) (continued)

($V_{CC} = 5V$, $R_L = \infty$, $T_A = T_{MIN}$ to T_{MAX} , unless otherwise noted. Typical values are at $T_A = +25^\circ C$.) (Note 1)

PARAMETER	SYMBOL	CONDITIONS	MIN	TYP	MAX	UNITS
Nonlinearity	NL	5-step staircase		0.4		%
Channel Delay	t_D	Difference in time between the 50% point of the output signals, Y to Pb and Y to Pr		< 1		ns
Group Delay	GD	$100kHz \leq f \leq 20MHz$, $V_{YOUT} = V_{PbOUT} = V_{PrOUT} = 2V_{P-P}$		26		ns
Group-Delay Variation	ΔGD	$100kHz \leq f \leq 20MHz$, $V_{YOUT} = V_{PbOUT} = V_{PrOUT} = 2V_{P-P}$		< 10		ns
Channel-to-Channel Group-Delay Matching	ΔGD_{CH-CH}	$V_{YOUT} = V_{PbOUT} = V_{PrOUT} = 2V_{P-P}$, Y to Pb and Y to Pr, $1MHz \leq f \leq 20MHz$		0.2		ns
Peak Signal-to-RMS Noise	SNR	$100kHz \leq f \leq 20MHz$, $V_{IN} = 1V_{P-P}$		60		dB
Power-Supply Rejection Ratio	PSRR _{AC}	$f = 100kHz$, $V_{RIPPLE} = 200mV_{P-P}$		60		dB
Output Impedance	Z_O	$f = 30MHz$		8		Ω
Input Capacitance	C_{IN}			1		pF
Capacitive-Load Drive	C_L	No sustained oscillations		25		pF

ELECTRICAL CHARACTERISTICS—MAX9501 (Dual Supply)

($V_{CC} = 5V$, $V_{EE} = -5V$, $R_L = \infty$, $T_A = T_{MIN}$ to T_{MAX} , unless otherwise noted. Typical values are at $T_A = +25^\circ C$.) (Note 1)

PARAMETER	SYMBOL	CONDITIONS	MIN	TYP	MAX	UNITS	
DC CHARACTERISTICS							
Positive Supply Voltage Range	V_{CC}	Guaranteed by PSRR	4.5	5.0	5.5	V	
Negative Supply Voltage Range	V_{EE}	Guaranteed by PSRR	-5.5	-5.0	-4.5	V	
V_{CC} Quiescent Supply Current (Per Channel)	I_{CC}			35	48	mA	
V_{EE} Supply Current (Per Channel)	I_{EE}			6	9	mA	
Input Voltage Range	V_{IN}	Guaranteed by voltage gain	0		1.4	V	
Voltage Gain	A_V	$V_{IN} = 0$ to $1.4V$	$R_L = 150\Omega$ to GND	+5.5	+6	+6.4	dB
			$R_L = 75\Omega$ to GND	+5.5	+6	+6.4	
Gain Matching	ΔA_V	Any two channels	-0.5	0	+0.5	dB	
Input Bias Current	I_B	$V_{IN} = 0V$		4	10	μA	
Input Resistance	R_{IN}	$V_{IN} = 0$ to $1.4V$	250	800		k Ω	
Output Offset Voltage	V_{OS}	$V_{IN} = 0V$	-0.2	0	+0.2	V	
Power-Supply Rejection Ratio	PSRR	$V_{CC} = 4.5V$ to $5.5V$, $V_{IN} = 1.4V$, $V_{EE} = -4.5V$ to $-5.5V$	40	60		dB	

Triple-Channel HDTV Filters

ELECTRICAL CHARACTERISTICS—MAX9501 (Dual Supply) (continued)

($V_{CC} = 5V$, $V_{EE} = -5V$, $R_L = \infty$, $T_A = T_{MIN}$ to T_{MAX} , unless otherwise noted. Typical values are at $T_A = +25^\circ C$.) (Note 1)

PARAMETER	SYMBOL	CONDITIONS	MIN	TYP	MAX	UNITS
AC CHARACTERISTICS ($R_L = 150\Omega$ to GND, unless otherwise noted)						
Passband Flatness	APB	$f = 0.1\text{MHz}$ to 30MHz , $V_{IN} = 1V_{P-P}$, $T_A = +25^\circ C$	± 4.0	± 1.5		dB
Attenuation	ASB	$f = 44.25\text{MHz}$, $V_{IN} = 1V_{P-P}$, $T_A = +25^\circ C$	38	45		dB
		$f = 74.25\text{MHz}$, $V_{IN} = 1V_{P-P}$		38		dB
Settling Time	t_s	$V_{IN} = 1V_{P-P}$, $V_{OUT} < 1\%$		150		ns
Slew Rate	SR	$V_{IN} = 1V_{P-P}$		100		V/ μs
Bar Response	BR	Bar time is one-half the active line of a 1080i format signal; the beginning 2.5% and the ending 2.5% of the bar time is ignored		0.4		K%
Nonlinearity	NL	5-step staircase		0.4		%
Channel Delay	t_D	Difference in time between the 50% point of the output signals, Y to Pb and Y to Pr		< 1		ns
Group Delay	GD	$100\text{kHz} \leq f \leq 20\text{MHz}$, $V_{YOUT} = V_{PbOUT} = V_{PrOUT} = 2V_{P-P}$		25		ns
Group-Delay Variation	ΔGD	$100\text{kHz} \leq f \leq 20\text{MHz}$, $V_{YOUT} = V_{PbOUT} = V_{PrOUT} = 2V_{P-P}$		< 10		ns
Channel-to-Channel Group-Delay Matching	ΔGD_{CH-CH}	$V_{YOUT} = V_{PbOUT} = V_{PrOUT} = 2V_{P-P}$, Y to Pb and Y to Pr, $1\text{MHz} \leq f \leq 20\text{MHz}$		0.6		ns
Peak Signal-to-RMS Noise	SNR	$100\text{kHz} \leq f \leq 20\text{MHz}$, $V_{IN} = 1V_{P-P}$		60		dB
Power-Supply Rejection Ratio	PSRR _{AC}	$f = 100\text{kHz}$, $V_{RIPPLE} = 200mV_{P-P}$		60		dB
Output Impedance	Z_O	$f = 30\text{MHz}$		8		Ω
Input Capacitance	C_{IN}			1		pF
Capacitive-Load Drive	C_L	No sustained oscillations		25		pF

Note 1: All specifications are 100% tested at $T_A = +25^\circ C$; temperature limits are guaranteed by design.

Triple-Channel HDTV Filters

Typical Operating Characteristics

www.datasheet4u.com
 (V_{CC} = 5V, R_L = 150Ω to GND, T_A = +25°C, unless otherwise noted.)

MAX9500/MAX9501

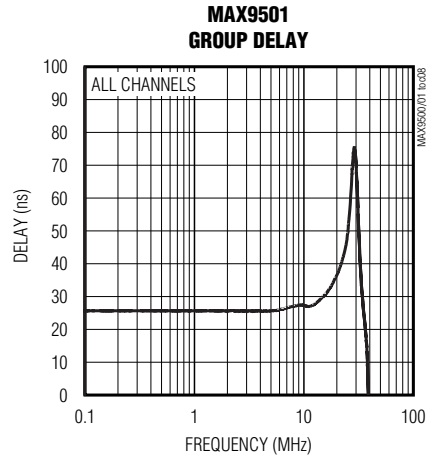
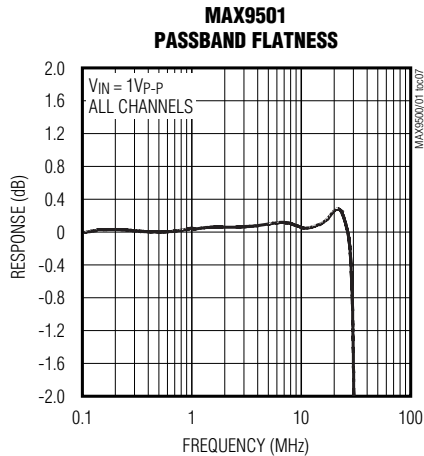
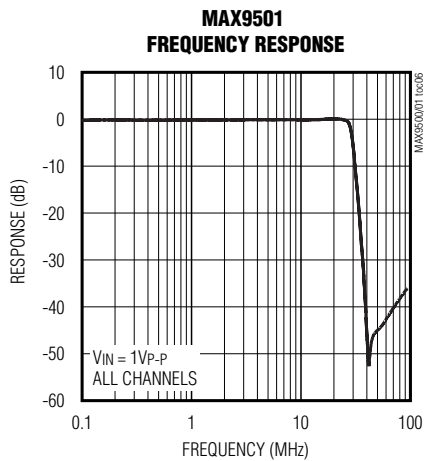
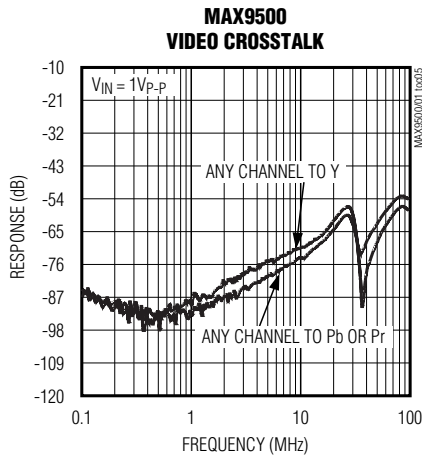
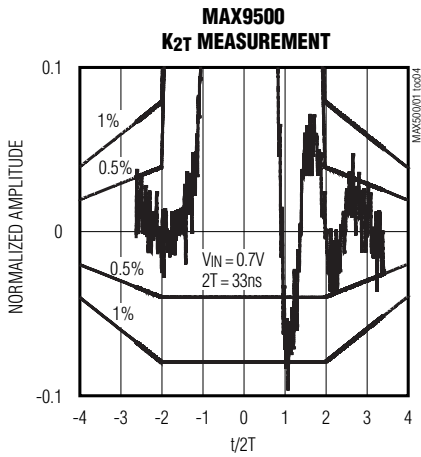
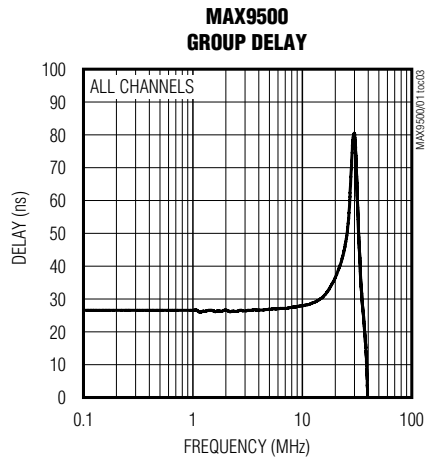
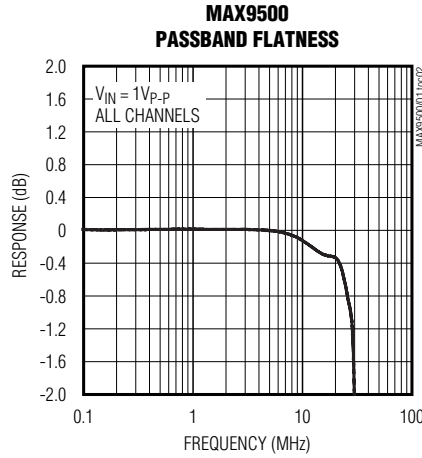
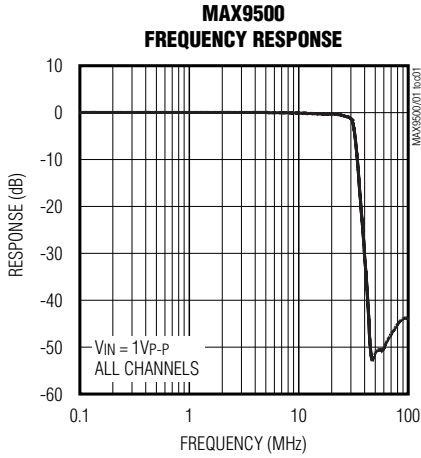

Triple-Channel HDTV Filters

Typical Operating Characteristics (continued)

($V_{CC} = 5V$, $R_L = 150\Omega$ to GND, $T_A = +25^\circ C$, unless otherwise noted.)

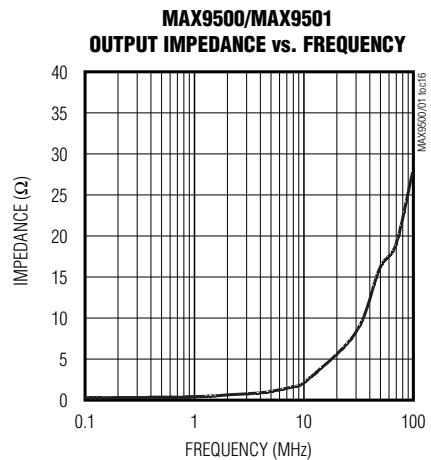
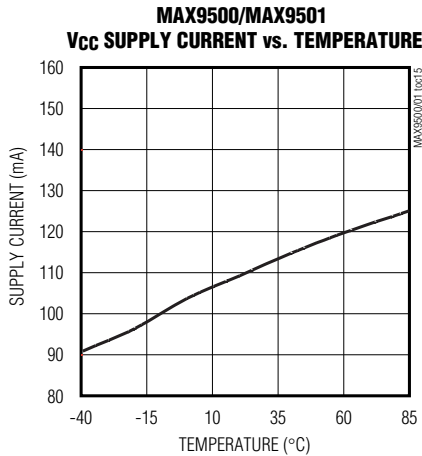
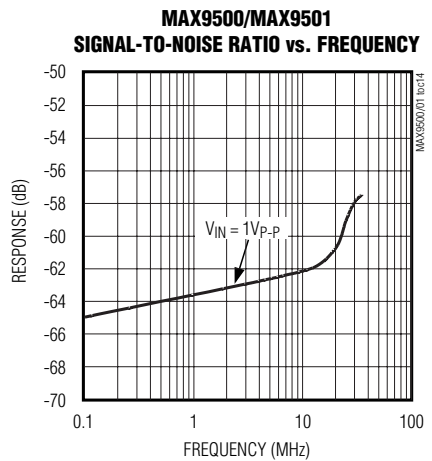
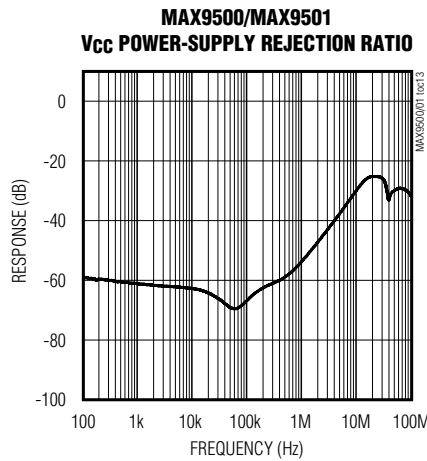
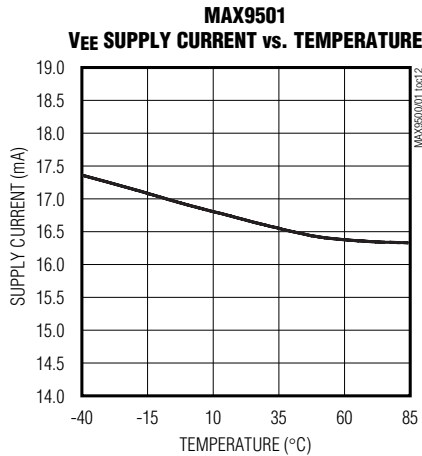
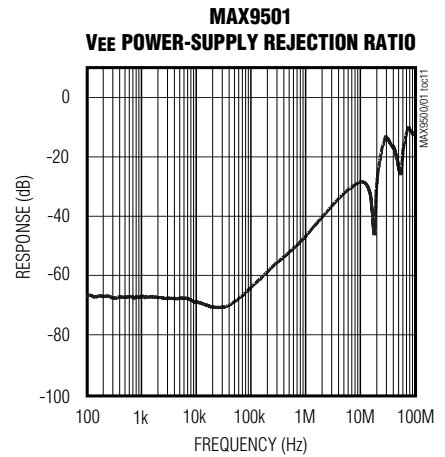
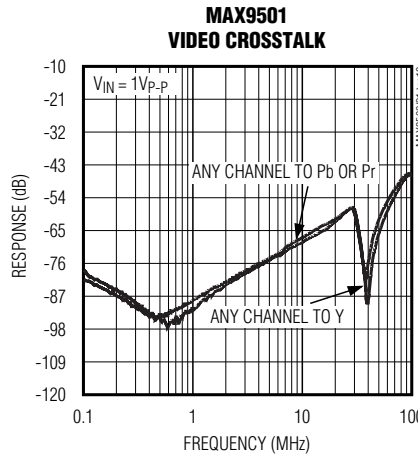
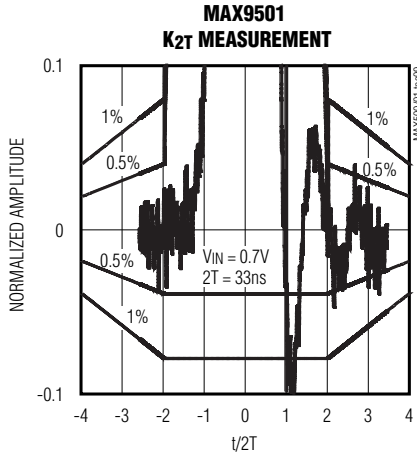

Triple-Channel HDTV Filters

MAX9500/MAX9501

Pin Description

www.datasheet4u.com

PIN		NAME	FUNCTION
MAX9500	MAX9501		
1, 7, 8, 9, 16	—	SUBG	Substrate Ground. Connect to ground.
2	2	YIN	Y Channel Input
3, 5	3, 5	GND	Ground
4	4	PbIN	Pb Channel Input
6	6	PrIN	Pr Channel Input
10	10	PrOUT	Pr Channel Output
11, 13, 15	11, 13, 15	V _{CC}	Positive Supply
12	12	PbOUT	Pb Channel Output
14	14	YOUT	Y Channel Output
—	1, 7, 8, 9, 16	V _{EE}	Negative Supply

Detailed Description

The MAX9500/MAX9501 are fully integrated solutions for filtering and buffering HDTV signals. The MAX9500 operates from a single +5V supply, while the MAX9501 operates from dual $\pm 5V$ supplies. The MAX9500/MAX9501 interface between the current-output DACs of an ATSC, MPEG decoder, and the external connections of a television, set-top box, or DVD player. The MAX9500/MAX9501 feature a DC-coupled input buffer with very low input capacitance, highly selective low-pass filters to remove out-of-band noise, and a gain of +6dB in the output amplifier to drive 75Ω back-terminated loads to unity gain. The DC-coupled input buffer eliminates sync crush, droop, and field tilt. The output load can be DC- or AC-coupled.

Filter

The MAX9500/MAX9501 reconstruction filters feature a 6th-order elliptical response, providing a 1.5dB flat passband response up to 30MHz. The filter meets the selectivity requirements of the EIA-770.3/SMPTE 274M filtering template, achieving > 40dB attenuation at 44.25MHz. The MAX9500/MAX9501 can also be used as anti-aliasing filters for HDTV component inputs.

Output Buffer

The MAX9500/MAX9501 output buffers provide +6dB of gain and can drive $2V_{p-p}$ into a single or double back-terminated load (150Ω or 75Ω , respectively) directly to ground. The output can be AC-coupled or DC-coupled.

Applications Information

Input Considerations

The MAX9500/MAX9501 inputs are normally DC-coupled. No AC-coupling capacitors are required because the input voltage range includes ground and extends up to 1.4V, allowing the MAX9500/MAX9501 to be directly connected to the output of a single-supply, current-output DAC without any external bias network.

The MAX9500/MAX9501 inputs can be AC-coupled. Use a fixed bias or video clamp to set the DC bias to ensure that the negative peak of the video signal is as near to 0V as possible. A video clamp is preferred because it limits the total swing of the signal and holds the blanking level constant.

Output Considerations

The MAX9500/MAX9501 outputs are normally DC-coupled, so no AC-coupling capacitors are required. For 0V input, the MAX9500 output voltage is 0.8V and the MAX9501 output voltage is 0V, typical. Connect the MAX9500/MAX9501 directly to a video cable with a 75Ω series back-termination resistor to match the impedance of the cable. Properly terminate the other end of the cable with a 75Ω load. The MAX9500/MAX9501 outputs can sink and source current allowing the device to be AC-coupled. However, AC-coupling the outputs will degrade the tilt.

Power-Supply Bypassing and Layout Considerations

The MAX9500 operates from a single +5V supply while the MAX9501 operates from dual $\pm 5V$ supplies. Bypass V_{CC} and V_{EE} (MAX9501) to GND with a $0.1\mu F$ capacitor as close to the device as possible, and an additional $1\mu F$ capacitor in parallel if any significant low-frequency disturbances are present in the vicinity of the MAX9500/MAX9501. Use an extensive ground plane to ensure optimum performance.

The input and output termination resistors should be placed as close to the device as possible to avoid performance degradation in the frequency response.

The PC board traces at the output should have 75Ω characteristic impedance when matching into a 75Ω characteristic impedance cable. Keep the board trace at the inputs and outputs of the MAX9500/MAX9501 as short as possible to minimize the parasitic stray capacitance and noise pickup.

Triple-Channel HDTV Filters

Pin Configurations

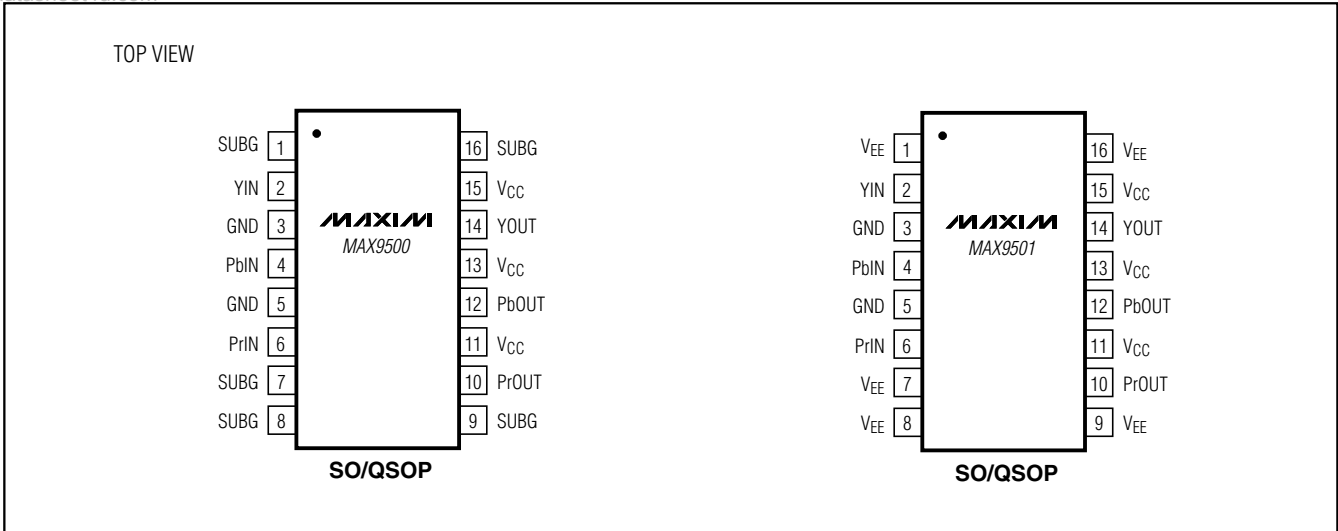

Chip Information

PROCESS: Bipolar

Triple-Channel HDTV Filters

Package Information

(The package drawing(s) in this data sheet may not reflect the most current specifications. For the latest package outline information, go to www.maxim-ic.com/packages.)

MAX9500/MAX9501

SOICN, EPS

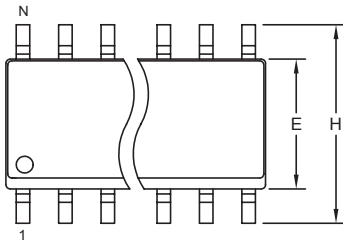

TOP VIEW

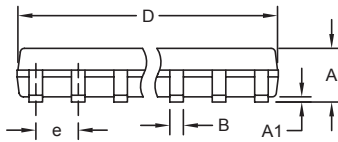

FRONT VIEW

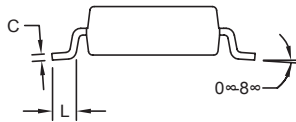

SIDE VIEW

DIM	INCHES		MILLIMETERS	
	MIN	MAX	MIN	MAX
A	0.053	0.069	1.35	1.75
A1	0.004	0.010	0.10	0.25
B	0.014	0.019	0.35	0.49
C	0.007	0.010	0.19	0.25
e	0.050 BSC		1.27 BSC	
E	0.150	0.157	3.80	4.00
H	0.228	0.244	5.80	6.20
L	0.016	0.050	0.40	1.27

VARIATIONS:

DIM	INCHES		MILLIMETERS		N	MS012
	MIN	MAX	MIN	MAX		
D	0.189	0.197	4.80	5.00	8	AA
D	0.337	0.344	8.55	8.75	14	AB
D	0.386	0.394	9.80	10.00	16	AC

NOTES:

1. D&E DO NOT INCLUDE MOLD FLASH.
2. MOLD FLASH OR PROTRUSIONS NOT TO EXCEED 0.15mm (.006").
3. LEADS TO BE COPLANAR WITHIN 0.10mm (.004").
4. CONTROLLING DIMENSION: MILLIMETERS.
5. MEETS JEDEC MS012.
6. N = NUMBER OF PINS.

<small>PROPRIETARY INFORMATION</small>	
TITLE: PACKAGE OUTLINE, .150" SOIC	
APPROVAL:	DOCUMENT CONTROL NO.: 21-0041
REV.: B	1/1

Triple-Channel HDTV Filters

Package Information (continued)

(The package drawing(s) in this data sheet may not reflect the most current specifications. For the latest package outline information, go to www.maxim-ic.com/packages.)

DIM	INCHES		MILLIMETERS	
	MIN	MAX	MIN	MAX
A	.061	.068	1.55	1.73
A1	.004	.0098	0.102	0.249
A2	.055	.061	1.40	1.55
B	.008	.012	0.20	0.30
C	.0075	.0098	0.191	0.249
D	SEE VARIATIONS			
E	.150	.157	3.81	3.99
e	.025 BSC		0.635 BSC	
H	.230	.244	5.84	6.20
h	.010	.016	0.25	0.41
L	.016	.035	0.41	0.89
N	SEE VARIATIONS			
α	0°	8°	0°	8°

	INCHES		MILLIMETERS		N
	MIN.	MAX.	MIN.	MAX.	
D	.189	.196	4.80	4.98	16 AB
S	.0020	.0070	0.05	0.18	
D	.337	.344	8.56	8.74	20 AD
S	.0500	.0550	1.270	1.397	
D	.337	.344	8.56	8.74	24 AE
S	.0250	.0300	0.635	0.762	
D	.386	.393	9.80	9.98	28 AF
S	.0250	.0300	0.635	0.762	

VARIATIONS:

NOTES:

- 1). D & E DO NOT INCLUDE MOLD FLASH OR PROTRUSIONS.
- 2). MOLD FLASH OR PROTRUSIONS NOT TO EXCEED .006" PER SIDE.
- 3). CONTROLLING DIMENSIONS: INCHES.
- 4). MEETS JEDEC MO137.

DALLAS SEMICONDUCTOR **MAXIM**

PROPRIETARY INFORMATION

TITLE:
PACKAGE OUTLINE, QSOP, .150", .025" LEAD PITCH

APPROVAL	DOCUMENT CONTROL NO. 21-0055	REV. E	1/1
----------	---------------------------------	-----------	-----

QSOP, EPS

Maxim cannot assume responsibility for use of any circuitry other than circuitry entirely embodied in a Maxim product. No circuit patent licenses are implied. Maxim reserves the right to change the circuitry and specifications without notice at any time.

10 **Maxim Integrated Products, 120 San Gabriel Drive, Sunnyvale, CA 94086 408-737-7600**