

FEATURES

- Latch-up proof**
- 3 pF off source capacitance**
- 26 pF off drain capacitance**
- 0.6 pC charge injection**
- Low leakage: 0.4 nA maximum at 85°C**
- ±9 V to ±22 V dual-supply operation**
- 9 V to 40 V single-supply operation**
- 48 V supply maximum ratings**
- Fully specified at ±15 V, ±20 V, +12 V, and +36 V**
- V_{SS} to V_{DD} analog signal range**

APPLICATIONS

- Automatic test equipment**
- Data acquisition**
- Instrumentation**
- Avionics**
- Audio and video switching**
- Communication systems**

GENERAL DESCRIPTION

The ADG5204 is a complementary metal oxide semiconductor (CMOS) analog multiplexer, comprising four single channels.

The ultralow capacitance and charge injection of these switches make them ideal solutions for data acquisition and sample-and-hold applications, where low glitch and fast settling are required. Fast switching speed together with high signal bandwidth make the ADG5204 suitable for video signal switching.

The ADG5204 is designed on a trench process, which guards against latch-up. A dielectric trench separates the P and N channel transistors, thereby preventing latch-up even under severe overvoltage conditions.

The ADG5204 switches one of four inputs to a common output, D, as determined by the 3-bit binary address lines, A0, A1, and EN. Logic 0 on the EN pin disables the device. Each switch conducts equally well in both directions when on, and each switch has an input signal range that extends to the supplies. In the off condition, signal levels up to the supplies are blocked. All switches exhibit break-before-make switching action.

FUNCTIONAL BLOCK DIAGRAM

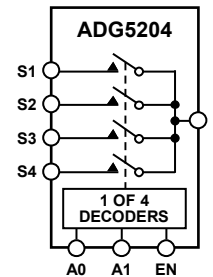

Figure 1.

PRODUCT HIGHLIGHTS

1. Trench Isolation Guards Against Latch-Up.
A dielectric trench separates the P and N channel transistors, thereby preventing latch-up even under severe overvoltage conditions.
2. Ultralow Capacitance and <1 pC Charge Injection.
3. Dual-Supply Operation.
For applications where the analog signal is bipolar, the ADG5204 can be operated from dual supplies up to ±22 V.
4. Single-Supply Operation.
For applications where the analog signal is unipolar, the ADG5204 can be operated from a single rail power supply up to 40 V.
5. 3 V Logic-Compatible Digital Inputs.
 $V_{INH} = 2.0\text{ V}$, $V_{INL} = 0.8\text{ V}$.
6. No V_L Logic Power Supply Required.

Rev. 0

Information furnished by Analog Devices is believed to be accurate and reliable. However, no responsibility is assumed by Analog Devices for its use, nor for any infringements of patents or other rights of third parties that may result from its use. Specifications subject to change without notice. No license is granted by implication or otherwise under any patent or patent rights of Analog Devices. Trademarks and registered trademarks are the property of their respective owners.

TABLE OF CONTENTS

Features	1	Absolute Maximum Ratings	8
Applications.....	1	ESD Caution.....	8
Functional Block Diagram	1	Pin Configurations and Function Descriptions	9
General Description	1	Truth Table	9
Product Highlights	1	Typical Performance Characteristics	10
Revision History	2	Test Circuits.....	14
Specifications.....	3	Terminology	16
±15 V Dual Supply	3	Trench Isolation	17
±20 V Dual Supply	4	Applications Information	18
12 V Single Supply.....	5	Outline Dimensions	19
36 V Single Supply.....	6	Ordering Guide	19
Continuous Current per Channel, Sx or D.....	7		

REVISION HISTORY

5/11—Revision 0: Initial Version

SPECIFICATIONS

±15 V DUAL SUPPLY

$V_{DD} = 15\text{ V} \pm 10\%$, $V_{SS} = -15\text{ V} \pm 10\%$, GND = 0 V, unless otherwise noted.

Table 1.

Parameter	25°C	-40°C to +85°C	-40°C to +125°C	Unit	Test Conditions/Comments
ANALOG SWITCH					
Analog Signal Range			V_{DD} to V_{SS}	V max	
On Resistance, R_{ON}	160	250	280	Ω typ Ω max	$V_S = \pm 10\text{ V}$, $I_S = -1\text{ mA}$, see Figure 24 $V_{DD} = +13.5\text{ V}$, $V_{SS} = -13.5\text{ V}$
On-Resistance Match Between Channels, ΔR_{ON}	4.5			Ω typ	$V_S = \pm 10\text{ V}$, $I_S = -1\text{ mA}$
On-Resistance Flatness, $R_{FLAT(ON)}$	8 38 50	9 65	10 70	Ω max Ω typ Ω max	$V_S = \pm 10\text{ V}$, $I_S = -1\text{ mA}$
LEAKAGE CURRENTS					
Source Off Leakage, I_S (Off)	0.01			nA typ	$V_{DD} = +16.5\text{ V}$, $V_{SS} = -16.5\text{ V}$ $V_S = V_D = \pm 10\text{ V}$, $V_D = \mp 10\text{ V}$, see Figure 23
Drain Off Leakage, I_D (Off)	0.1 0.01	0.2	0.4	nA max nA typ	$V_S = V_D = \pm 10\text{ V}$, $V_D = \mp 10\text{ V}$, see Figure 23
Channel On Leakage, I_D , I_S (On)	0.1 0.02 0.2	0.4 0.5	1.2 1.2	nA max nA typ nA max	$V_S = V_D = \pm 10\text{ V}$, see Figure 26
DIGITAL INPUTS					
Input High Voltage, V_{INH}			2.0	V min	
Input Low Voltage, V_{INL}			0.8	V max	
Input Current, I_{INL} or I_{INH}	0.002		± 0.1	μA typ μA max	$V_{IN} = V_{GND}$ or V_{DD}
Digital Input Capacitance, C_{IN}	3			pF typ	
DYNAMIC CHARACTERISTICS¹					
Transition Time, $t_{TRANSITION}$	175			ns typ	$R_L = 300\ \Omega$, $C_L = 35\text{ pF}$
t_{ON} (EN)	230	285	320	ns max	$V_S = 10\text{ V}$, see Figure 29
t_{OFF} (EN)	155			ns typ	$R_L = 300\ \Omega$, $C_L = 35\text{ pF}$
	205	255	285	ns max	$V_S = 10\text{ V}$, see Figure 31
Break-Before-Make Time Delay, t_D	150			ns typ	$R_L = 300\ \Omega$, $C_L = 35\text{ pF}$
	175	200	215	ns max	$V_S = 10\text{ V}$, see Figure 31
	80			ns typ	$R_L = 300\ \Omega$, $C_L = 35\text{ pF}$
			30	ns min	$V_{S1} = V_{S2} = 10\text{ V}$, see Figure 30
Charge Injection, Q_{INJ}	-0.6			pC typ	$V_S = 0\text{ V}$, $R_S = 0\ \Omega$, $C_L = 1\text{ nF}$, see Figure 32
Off Isolation	-80			dB typ	$R_L = 50\ \Omega$, $C_L = 5\text{ pF}$, $f = 100\text{ kHz}$, see Figure 25
Channel-to-Channel Crosstalk	-80			dB typ	$R_L = 50\ \Omega$, $C_L = 5\text{ pF}$, $f = 1\text{ MHz}$, see Figure 28
-3 dB Bandwidth	136			MHz typ	$R_L = 50\ \Omega$, $C_L = 5\text{ pF}$, see Figure 27
Insertion Loss	-6.8			dB typ	$R_L = 50\ \Omega$, $C_L = 5\text{ pF}$, $f = 1\text{ MHz}$, see Figure 27
C_S (Off)	3			pF typ	$V_S = 0\text{ V}$, $f = 1\text{ MHz}$
C_D (Off)	26			pF typ	$V_S = 0\text{ V}$, $f = 1\text{ MHz}$
C_D , C_S (On)	30			pF typ	$V_S = 0\text{ V}$, $f = 1\text{ MHz}$
POWER REQUIREMENTS					
I_{DD}	45			μA typ	$V_{DD} = +16.5\text{ V}$, $V_{SS} = -16.5\text{ V}$ Digital inputs = 0 V or V_{DD}
	55		70	μA max	
I_{SS}	0.001			μA typ	Digital inputs = 0 V or V_{DD}
			1	μA max	
V_{DD}/V_{SS}			$\pm 9/\pm 22$	V min/max	GND = 0 V

¹ Guaranteed by design; not subject to production test.

ADG5204

±20 V DUAL SUPPLY

$V_{DD} = +20\text{ V} \pm 10\%$, $V_{SS} = -20\text{ V} \pm 10\%$, GND = 0 V, unless otherwise noted.

Table 2.

Parameter	25°C	-40°C to +85°C	-40°C to +125°C	Unit	Test Conditions/Comments
ANALOG SWITCH					
Analogue Signal Range			V_{DD} to V_{SS}	V max	
On Resistance, R_{ON}	140			Ω typ	$V_S = \pm 15\text{ V}$, $I_S = -1\text{ mA}$, see Figure 24
	160	200	230	Ω max	$V_{DD} = +18\text{ V}$, $V_{SS} = -18\text{ V}$
On-Resistance Match Between Channels, ΔR_{ON}	4.5			Ω typ	$V_S = \pm 15\text{ V}$, $I_S = -1\text{ mA}$
	8	9	10	Ω max	
On-Resistance Flatness, $R_{FLAT(ON)}$	33			Ω typ	$V_S = \pm 15\text{ V}$, $I_S = -1\text{ mA}$
	45	55	60	Ω max	
LEAKAGE CURRENTS					
Source Off Leakage, I_S (Off)	0.01			nA typ	$V_{DD} = +22\text{ V}$, $V_{SS} = -22\text{ V}$
	0.1	0.2	0.4	nA max	$V_S = \pm 15\text{ V}$, $V_D = \mp 15\text{ V}$, see Figure 23
Drain Off Leakage, I_D (Off)	0.01			nA typ	
	0.1	0.4	1.2	nA max	$V_S = \pm 15\text{ V}$, $V_D = \mp 15\text{ V}$, see Figure 23
Channel On Leakage, I_D , I_S (On)	0.02			nA typ	$V_S = V_D = \pm 15\text{ V}$, see Figure 26
	0.2	0.5	1.2	nA max	
DIGITAL INPUTS					
Input High Voltage, V_{INH}			2.0	V min	
Input Low Voltage, V_{INL}			0.8	V max	
Input Current, I_{INL} or I_{INH}	0.002			μA typ	$V_{IN} = V_{GND}$ or V_{DD}
			± 0.1	μA max	
Digital Input Capacitance, C_{IN}	3			pF typ	
DYNAMIC CHARACTERISTICS¹					
Transition Time, $t_{TRANSITION}$	160			ns typ	$R_L = 300\ \Omega$, $C_L = 35\text{ pF}$
	215	260	290	ns max	$V_S = 10\text{ V}$, see Figure 29
t_{ON} (EN)	150			ns typ	$R_L = 300\ \Omega$, $C_L = 35\text{ pF}$
	185	225	255	ns max	$V_S = 10\text{ V}$, see Figure 31
t_{OFF} (EN)	150			ns typ	$R_L = 300\ \Omega$, $C_L = 35\text{ pF}$
	175	195	210	ns max	$V_S = 10\text{ V}$, see Figure 31
Break-Before-Make Time Delay, t_D	75			ns typ	$R_L = 300\ \Omega$, $C_L = 35\text{ pF}$
			30	ns min	$V_{S1} = V_{S2} = 10\text{ V}$, see Figure 30
Charge Injection, Q_{INJ}	-0.6			pC typ	$V_S = 0\text{ V}$, $R_S = 0\ \Omega$, $C_L = 1\text{ nF}$, see Figure 32
Off Isolation	-80			dB typ	$R_L = 50\ \Omega$, $C_L = 5\text{ pF}$, $f = 100\text{ kHz}$, see Figure 25
Channel-to-Channel Crosstalk	-80			dB typ	$R_L = 50\ \Omega$, $C_L = 5\text{ pF}$, $f = 1\text{ MHz}$, see Figure 28
-3 dB Bandwidth	150			MHz typ	$R_L = 50\ \Omega$, $C_L = 5\text{ pF}$, see Figure 27
Insertion Loss	-6			dB typ	$R_L = 50\ \Omega$, $C_L = 5\text{ pF}$, $f = 1\text{ MHz}$, see Figure 27
C_S (Off)	3			pF typ	$V_S = 0\text{ V}$, $f = 1\text{ MHz}$
C_D (Off)	26			pF typ	$V_S = 0\text{ V}$, $f = 1\text{ MHz}$
C_D , C_S (On)	30			pF typ	$V_S = 0\text{ V}$, $f = 1\text{ MHz}$
POWER REQUIREMENTS					
I_{DD}	50			μA typ	$V_{DD} = +22\text{ V}$, $V_{SS} = -22\text{ V}$
	70		110	μA max	Digital inputs = 0 V or V_{DD}
I_{SS}	0.001			μA typ	Digital inputs = 0 V or V_{DD}
			1	μA max	
V_{DD}/V_{SS}			$\pm 9/\pm 22$	V min/max	GND = 0 V

¹ Guaranteed by design; not subject to production test.

12 V SINGLE SUPPLY

$V_{DD} = 12\text{ V} \pm 10\%$, $V_{SS} = 0\text{ V}$, $GND = 0\text{ V}$, unless otherwise noted.

Table 3.

Parameter	25°C	-40°C to +85°C	-40°C to +125°C	Unit	Test Conditions/Comments
ANALOG SWITCH					
Analog Signal Range			0 V to V_{DD}	V max	
On Resistance, R_{ON}	340 500	610	700	Ω typ Ω max	$V_S = 0\text{ V to }10\text{ V}$, $I_S = -1\text{ mA}$, see Figure 24 $V_{DD} = 10.8\text{ V}$, $V_{SS} = 0\text{ V}$
On-Resistance Match Between Channels, ΔR_{ON}	5			Ω typ	$V_S = 0\text{ V to }10\text{ V}$, $I_S = -1\text{ mA}$
On-Resistance Flatness, $R_{FLAT(ON)}$	20 145 280	21 335	22 370	Ω max Ω typ Ω max	$V_S = 0\text{ V to }10\text{ V}$, $I_S = -1\text{ mA}$
LEAKAGE CURRENTS					
Source Off Leakage, I_S (Off)	0.01 0.1	0.2	0.4	nA typ nA max	$V_{DD} = 13.2\text{ V}$, $V_{SS} = 0\text{ V}$ $V_S = 1\text{ V}/10\text{ V}$, $V_D = 10\text{ V}/1\text{ V}$, see Figure 23
Drain Off Leakage, I_D (Off)	0.01 0.1	0.4	1.2	nA typ nA max	$V_S = 1\text{ V}/10\text{ V}$, $V_D = 10\text{ V}/1\text{ V}$, see Figure 23
Channel On Leakage, I_D , I_S (On)	0.02 0.2	0.5	1.2	nA typ nA max	$V_S = V_D = 1\text{ V}/10\text{ V}$, see Figure 26
DIGITAL INPUTS					
Input High Voltage, V_{INH}			2.0	V min	
Input Low Voltage, V_{INL}			0.8	V max	
Input Current, I_{INL} or I_{INH}	0.002		± 0.1	μA typ μA max	$V_{IN} = V_{GND}$ or V_{DD}
Digital Input Capacitance, C_{IN}	3			pF typ	
DYNAMIC CHARACTERISTICS¹					
Transition Time, $t_{TRANSITION}$	240 350	445	515	ns typ ns max	$R_L = 300\ \Omega$, $C_L = 35\text{ pF}$ $V_S = 8\text{ V}$, see Figure 29
t_{ON} (EN)	250 335	420	485	ns typ ns max	$R_L = 300\ \Omega$, $C_L = 35\text{ pF}$ $V_S = 8\text{ V}$, see Figure 31
t_{OFF} (EN)	160 195	220	240	ns typ ns max	$R_L = 300\ \Omega$, $C_L = 35\text{ pF}$ $V_S = 8\text{ V}$, see Figure 31
Break-Before-Make Time Delay, t_D	140		60	ns typ ns min	$R_L = 300\ \Omega$, $C_L = 35\text{ pF}$ $V_{S1} = V_{S2} = 8\text{ V}$, see Figure 30
Charge Injection, Q_{INJ}	-1.2			pC typ	$V_S = 6\text{ V}$, $R_S = 0\ \Omega$, $C_L = 1\text{ nF}$, see Figure 32
Off Isolation	-80			dB typ	$R_L = 50\ \Omega$, $C_L = 5\text{ pF}$, $f = 1\text{ MHz}$, see Figure 25
Channel-to-Channel Crosstalk	-80			dB typ	$R_L = 50\ \Omega$, $C_L = 5\text{ pF}$, $f = 1\text{ MHz}$, see Figure 28
-3 dB Bandwidth	106			MHz typ	$R_L = 50\ \Omega$, $C_L = 5\text{ pF}$, see Figure 27
Insertion Loss	-11			dB typ	$R_L = 50\ \Omega$, $C_L = 5\text{ pF}$, $f = 1\text{ MHz}$, see Figure 27
C_S (Off)	3.5			pF typ	$V_S = 6\text{ V}$, $f = 1\text{ MHz}$
C_D (Off)	29			pF typ	$V_S = 6\text{ V}$, $f = 1\text{ MHz}$
C_D , C_S (On)	33			pF typ	$V_S = 6\text{ V}$, $f = 1\text{ MHz}$
POWER REQUIREMENTS					
I_{DD}	40		65	μA typ μA max	$V_{DD} = 13.2\text{ V}$ Digital inputs = 0 V or V_{DD}
V_{DD}			9/40	V min/max	$GND = 0\text{ V}$, $V_{SS} = 0\text{ V}$

¹ Guaranteed by design; not subject to production test.

ADG5204

36 V SINGLE SUPPLY

$V_{DD} = 36\text{ V} \pm 10\%$, $V_{SS} = 0\text{ V}$, $GND = 0\text{ V}$, unless otherwise noted.

Table 4.

Parameter	25°C	−40°C to +85°C	−40°C to +125°C	Unit	Test Conditions/Comments
ANALOG SWITCH					
Analogue Signal Range			0 V to V_{DD}	V max	
On Resistance, R_{ON}	150 170	215	245	Ω typ Ω max	$V_S = 0\text{ V to }30\text{ V}$, $I_S = -1\text{ mA}$, see Figure 24 $V_{DD} = 32.4\text{ V}$, $V_{SS} = 0\text{ V}$
On-Resistance Match Between Channels, ΔR_{ON}	4.5			Ω typ	$V_S = 0\text{ V to }30\text{ V}$, $I_S = -1\text{ mA}$
On-Resistance Flatness, $R_{FLAT(ON)}$	8 35 50	9 60	10 65	Ω max Ω typ Ω max	$V_S = 0\text{ V to }30\text{ V}$, $I_S = -1\text{ mA}$
LEAKAGE CURRENTS					
Source Off Leakage, I_S (Off)	0.01 0.1	0.2	0.4	nA typ nA max	$V_{DD} = 39.6\text{ V}$, $V_{SS} = 0\text{ V}$ $V_S = 1\text{ V}/30\text{ V}$, $V_D = 30\text{ V}/1\text{ V}$, see Figure 23
Drain Off Leakage, I_D (Off)	0.01 0.1	0.4	1.2	nA typ nA max	$V_S = 1\text{ V}/30\text{ V}$, $V_D = 30\text{ V}/1\text{ V}$, see Figure 23
Channel On Leakage, I_D , I_S (On)	0.02 0.2	0.5	1.2	nA typ nA max	$V_S = V_D = 1\text{ V}/30\text{ V}$, see Figure 26
DIGITAL INPUTS					
Input High Voltage, V_{INH}			2.0	V min	
Input Low Voltage, V_{INL}			0.8	V max	
Input Current, I_{INL} or I_{INH}	0.002		± 0.1	μA typ μA max	$V_{IN} = V_{GND}$ or V_{DD}
Digital Input Capacitance, C_{IN}	3			pF typ	
DYNAMIC CHARACTERISTICS¹					
Transition Time, $t_{TRANSITION}$	180 250	275	305	ns typ ns max	$R_L = 300\ \Omega$, $C_L = 35\text{ pF}$ $V_S = 18\text{ V}$, see Figure 29
t_{ON} (EN)	170 220	251	285	ns typ ns max	$R_L = 300\ \Omega$, $C_L = 35\text{ pF}$ $V_S = 18\text{ V}$, see Figure 31
t_{OFF} (EN)	170 210	215	220	ns typ ns max	$R_L = 300\ \Omega$, $C_L = 35\text{ pF}$ $V_S = 18\text{ V}$, see Figure 31
Break-Before-Make Time Delay, t_D	80		30	ns typ ns min	$R_L = 300\ \Omega$, $C_L = 35\text{ pF}$ $V_{S1} = V_{S2} = 18\text{ V}$, see Figure 30
Charge Injection, Q_{INJ}	−0.6			pC typ	$V_S = 18\text{ V}$, $R_S = 0\ \Omega$, $C_L = 1\text{ nF}$, see Figure 32
Off Isolation	−80			dB typ	$R_L = 50\ \Omega$, $C_L = 5\text{ pF}$, $f = 1\text{ MHz}$, see Figure 25
Channel-to-Channel Crosstalk	−80			dB typ	$R_L = 50\ \Omega$, $C_L = 5\text{ pF}$, $f = 1\text{ MHz}$, see Figure 28
−3 dB Bandwidth	136			MHz typ	$R_L = 50\ \Omega$, $C_L = 5\text{ pF}$, see Figure 27
Insertion Loss	−6.7			dB typ	$R_L = 50\ \Omega$, $C_L = 5\text{ pF}$, $f = 1\text{ MHz}$, see Figure 27
C_S (Off)	3			pF typ	$V_S = 18\text{ V}$, $f = 1\text{ MHz}$
C_D (Off)	26			pF typ	$V_S = 18\text{ V}$, $f = 1\text{ MHz}$
C_D , C_S (On)	30			pF typ	$V_S = 18\text{ V}$, $f = 1\text{ MHz}$
POWER REQUIREMENTS					
I_{DD}	85 100		130	μA typ μA max	$V_{DD} = 39.6\text{ V}$ Digital inputs = 0 V or V_{DD}
V_{DD}			9/40	V min/max	$GND = 0\text{ V}$, $V_{SS} = 0\text{ V}$

¹ Guaranteed by design; not subject to production test.

CONTINUOUS CURRENT PER CHANNEL, S_x OR D

Table 5.

Parameter	25°C	85°C	125°C	Unit
CONTINUOUS CURRENT, S _x OR D PINS				
$V_{DD} = +15\text{ V}, V_{SS} = -15\text{ V}$				
TSSOP ($\theta_{JA} = 112.6^\circ\text{C/W}$)	24.5	7.5	2.8	mA max
LFCSP ($\theta_{JA} = 30.4^\circ\text{C/W}$)	35.7	7.7	2.8	mA max
$V_{DD} = +20\text{ V}, V_{SS} = -20\text{ V}$				
TSSOP ($\theta_{JA} = 112.6^\circ\text{C/W}$)	26	7.5	2.8	mA max
LFCSP ($\theta_{JA} = 30.4^\circ\text{C/W}$)	37	7.7	2.8	mA max
$V_{DD} = 12\text{ V}, V_{SS} = 0\text{ V}$				
TSSOP ($\theta_{JA} = 112.6^\circ\text{C/W}$)	18	7	2.8	mA max
LFCSP ($\theta_{JA} = 30.4^\circ\text{C/W}$)	28	7.7	2.8	mA max
$V_{DD} = 36\text{ V}, V_{SS} = 0\text{ V}$				
TSSOP ($\theta_{JA} = 112.6^\circ\text{C/W}$)	30	7.7	2.8	mA max
LFCSP ($\theta_{JA} = 30.4^\circ\text{C/W}$)	41	7.7	2.8	mA max

ABSOLUTE MAXIMUM RATINGS

$T_A = 25^\circ\text{C}$, unless otherwise noted.

Table 6.

Parameter	Rating
V_{DD} to V_{SS}	48 V
V_{DD} to GND	-0.3 V to +48 V
V_{SS} to GND	+0.3 V to -48 V
Analog Inputs ¹	$V_{SS} - 0.3\text{ V}$ to $V_{DD} + 0.3\text{ V}$ or 30 mA, whichever occurs first
Digital Inputs ¹	$V_{SS} - 0.3\text{ V}$ to $V_{DD} + 0.3\text{ V}$ or 30 mA, whichever occurs first
Peak Current, Sx or D Pins	81 mA (pulsed at 1 ms, 10% duty cycle maximum)
Continuous Current, Sx or D ²	Data + 15%
Operating Temperature Range	-40°C to +125°C
Storage Temperature Range	-65°C to +150°C
Junction Temperature	150°C
Thermal Impedance, θ_{JA}	
16-Lead TSSOP, θ_{JA} Thermal Impedance (4-Layer Board)	112.6°C/W
16-Lead LFCSP, θ_{JA} Thermal Impedance (4-Layer Board)	30.4°C/W
Reflow Soldering Peak Temperature, Pb Free	260(+0/-5)°C

¹ Overvoltages at the Sx and D pins are clamped by internal diodes. Limit current to the maximum ratings given.

² See Table 5.

Stresses above those listed under Absolute Maximum Ratings may cause permanent damage to the device. This is a stress rating only; functional operation of the device at these or any other conditions above those indicated in the operational section of this specification is not implied. Exposure to absolute maximum rating conditions for extended periods may affect device reliability.

Only one absolute maximum rating can be applied at any one time.

ESD CAUTION



ESD (electrostatic discharge) sensitive device.

Charged devices and circuit boards can discharge without detection. Although this product features patented or proprietary protection circuitry, damage may occur on devices subjected to high energy ESD. Therefore, proper ESD precautions should be taken to avoid performance degradation or loss of functionality.

PIN CONFIGURATIONS AND FUNCTION DESCRIPTIONS

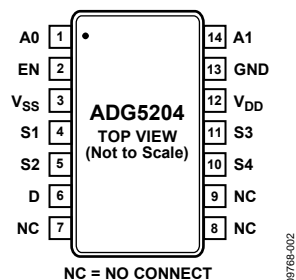
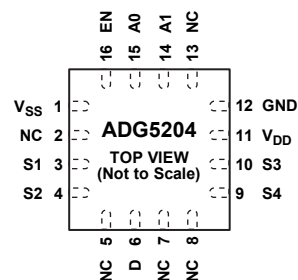

Figure 2. TSSOP Pin Configuration



- NOTES
 1. NC = NO CONNECT.
 2. EXPOSED PAD TIED TO SUBSTRATE, V_{SS}.

Figure 3. LFCSP Pin Configuration

Table 7. Pin Function Descriptions

Pin No.		Mnemonic	Description
TSSOP	LFCSP		
1	15	A0	Logic Control Input.
2	16	EN	Active High Digital Input. When this pin is low, the device is disabled and all switches are off. When this pin is high, the Ax logic inputs determine the on switches.
3	1	V _{SS}	Most Negative Power Supply Potential.
4	3	S1	Source Terminal. Can be an input or an output.
5	4	S2	Source Terminal. Can be an input or an output.
6	6	D	Drain Terminal. Can be an input or an output.
7 to 9	2, 5, 7, 8, 13	NC	No Connect. These pins are open.
10	9	S4	Source Terminal. Can be an input or an output.
11	10	S3	Source Terminal. Can be an input or an output.
12	11	V _{DD}	Most Positive Power Supply Potential.
13	12	GND	Ground (0 V) Reference.
14	14	A1	Logic Control Input.
N/A ¹	EP	Exposed Pad	Exposed Pad. The exposed pad is connected internally. For increased reliability of the solder joints and maximum thermal capability, it is recommended that the pad be soldered to the substrate, V _{SS} .

¹ N/A means not applicable.

TRUTH TABLE

Table 8.

EN	A1	A0	S1	S2	S3	S4
0	X ¹	X ¹	Off	Off	Off	Off
1	0	0	On	Off	Off	Off
1	0	1	Off	On	Off	Off
1	1	0	Off	Off	On	Off
1	1	1	Off	Off	Off	On

¹ X is don't care.

TYPICAL PERFORMANCE CHARACTERISTICS

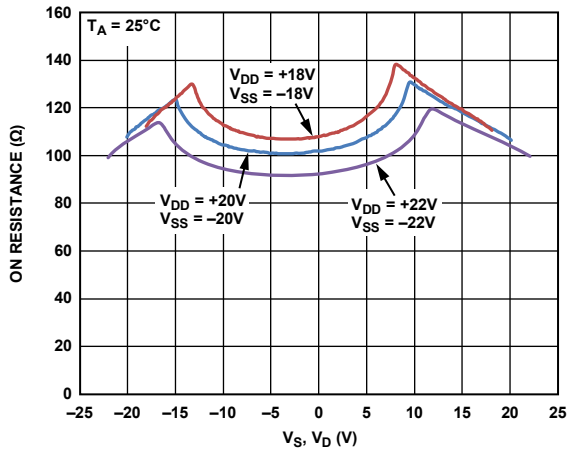

Figure 4. R_{ON} as a Function of V_D or V_S, Dual Supply

09768-104

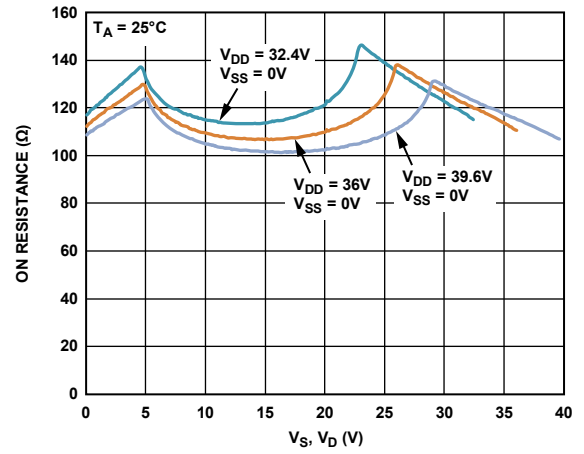

Figure 7. R_{ON} as a Function of V_D or V_S, Single Supply

09768-107

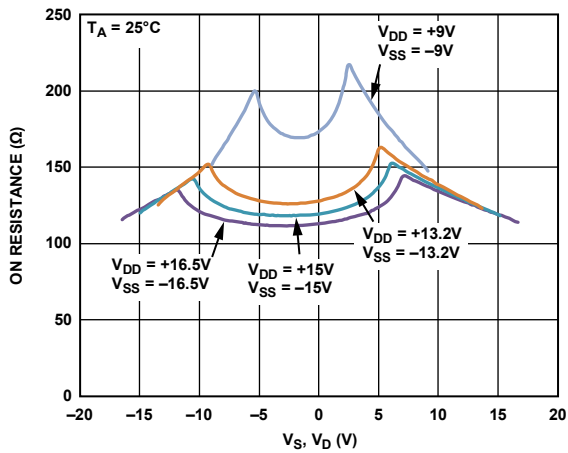

Figure 5. R_{ON} as a Function of V_D or V_S, Dual Supply

09768-105

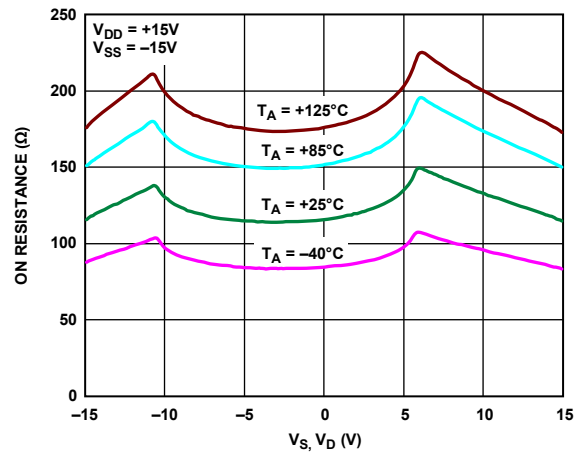

Figure 8. R_{ON} as a Function of V_D or V_S, for Different Temperatures, ±15 V Dual Supply

09768-108

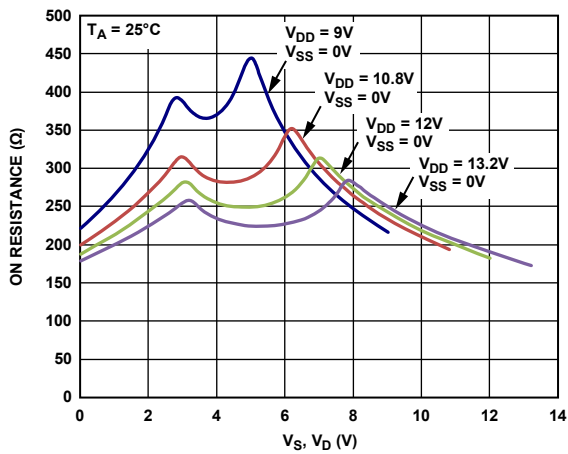

Figure 6. R_{ON} as a Function of V_D or V_S, Single Supply

09768-106

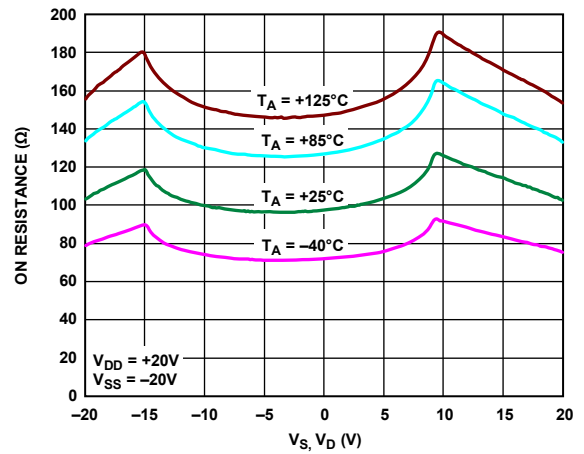

Figure 9. R_{ON} as a Function of V_D or V_S, for Different Temperatures, ±20 V Dual Supply

09768-109

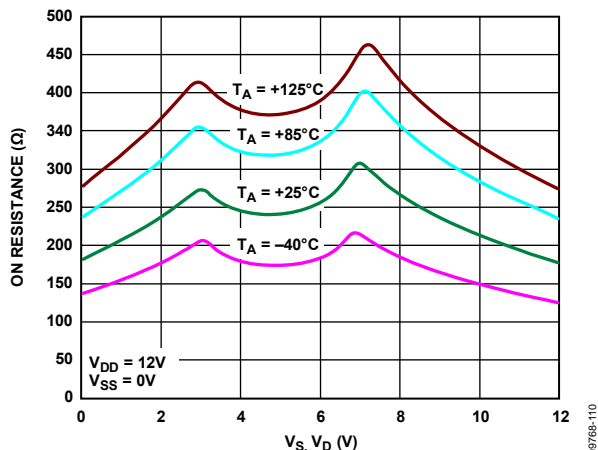

Figure 10. R_{ON} as a Function of V_D or V_S for Different Temperatures, 12 V Single Supply

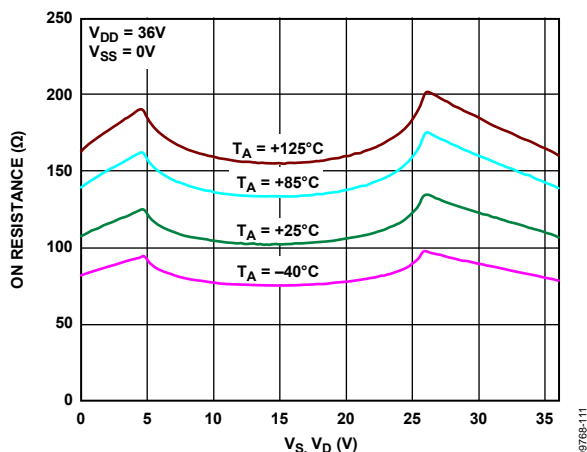

Figure 11. R_{ON} as a Function of V_D or V_S for Different Temperatures, 36 V Single Supply

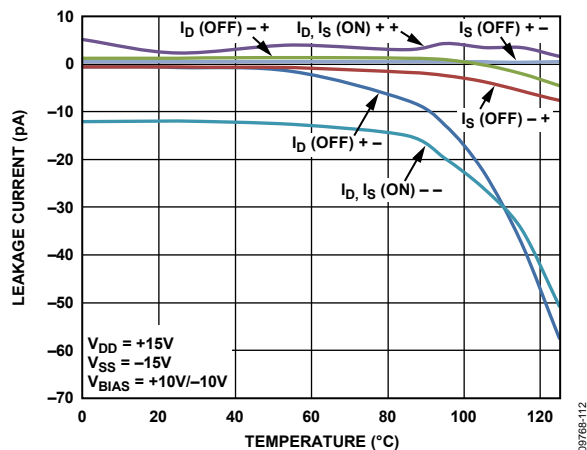

Figure 12. Leakage Current vs. Temperature, ±15 V Dual Supply

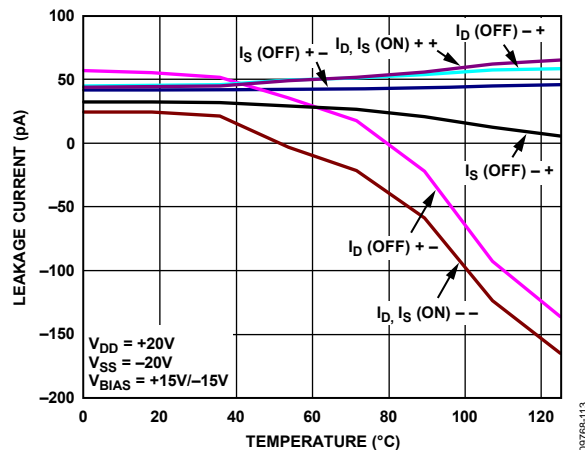

Figure 13. Leakage Current vs. Temperature, ±20 V Dual Supply

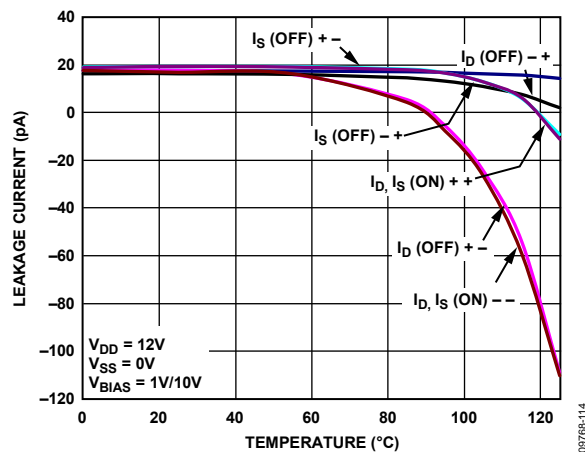

Figure 14. Leakage Current vs. Temperature, 12 V Single Supply

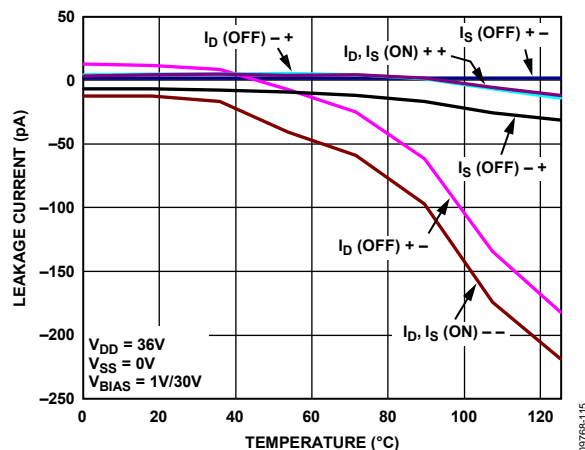

Figure 15. Leakage Current vs. Temperature, 36 V Single Supply

ADG5204

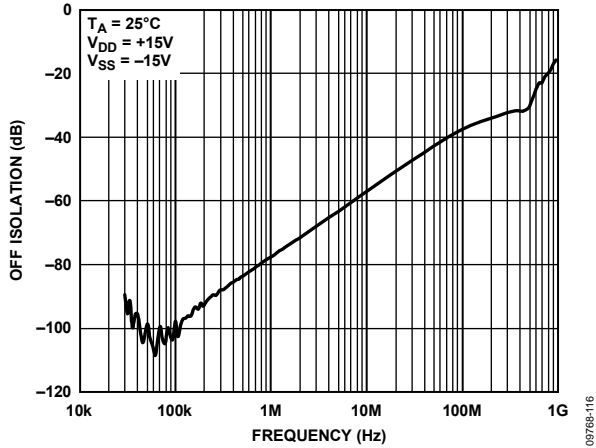

Figure 16. Off Isolation vs. Frequency, ±15 V Dual Supply

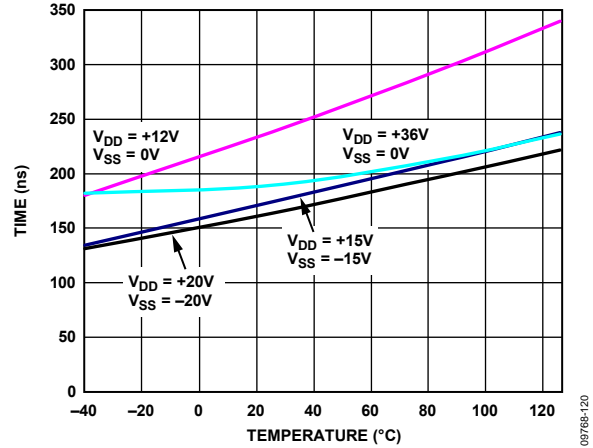

Figure 19. Transition Time vs. Temperature

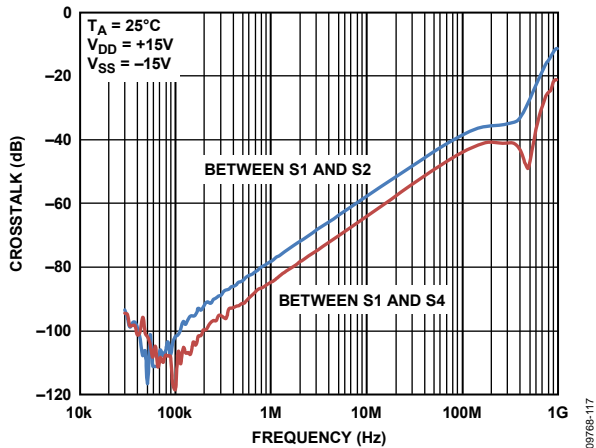

Figure 17. Crosstalk vs. Frequency, ±15 V Dual Supply

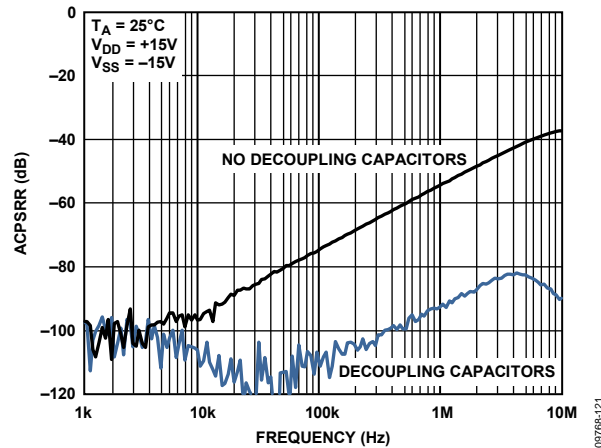

Figure 20. ACPSRR vs. Frequency, ±15 V Dual Supply

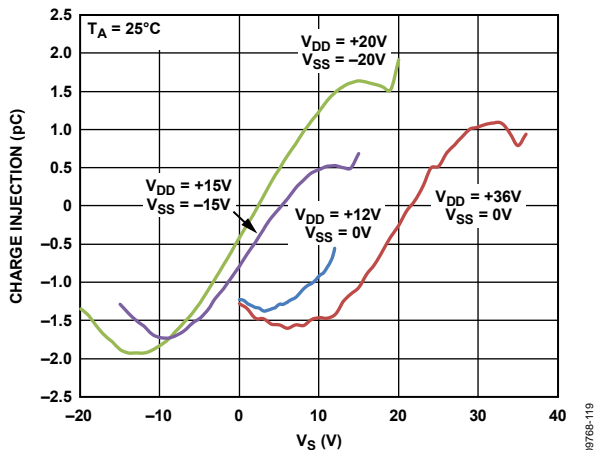

Figure 18. Charge Injection vs. Source Voltage

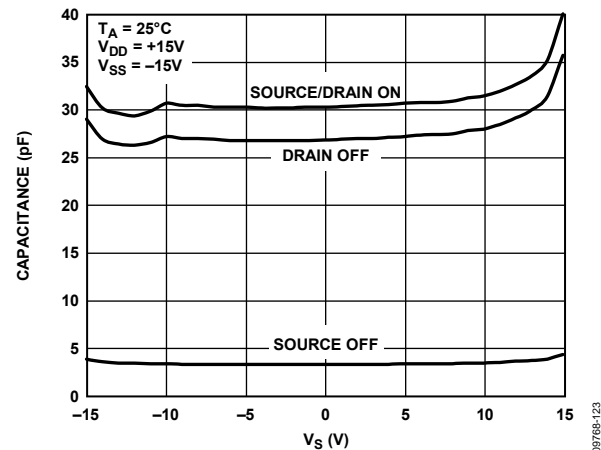

Figure 21. Capacitance vs. Source Voltage, Dual Supply

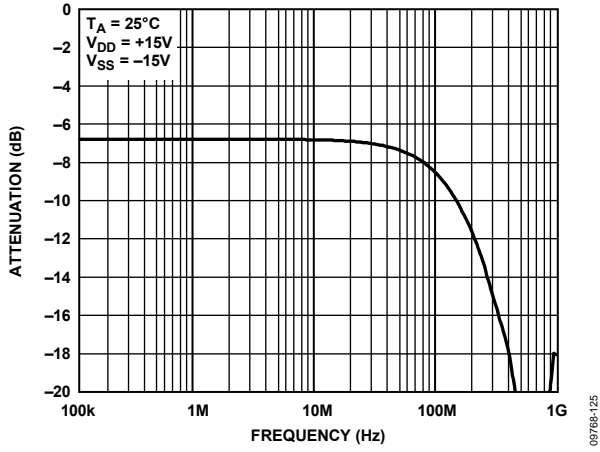

Figure 22. Bandwidth

TEST CIRCUITS

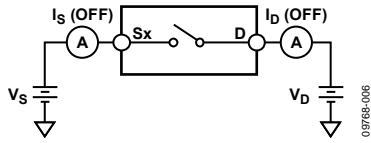

Figure 23. Off Leakage

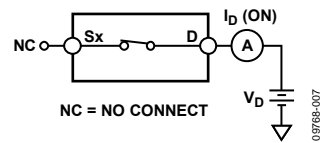

Figure 26. On Leakage

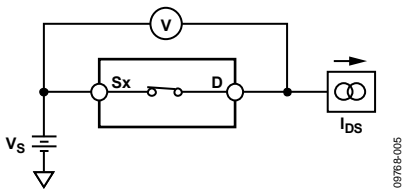

Figure 24. On Resistance

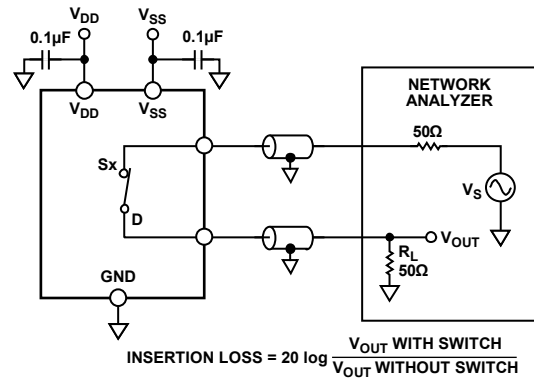

Figure 27. Bandwidth

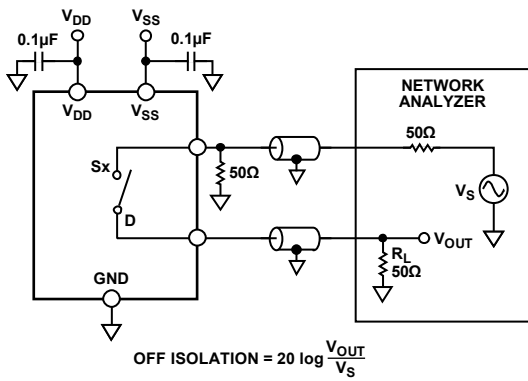

Figure 25. Off Isolation

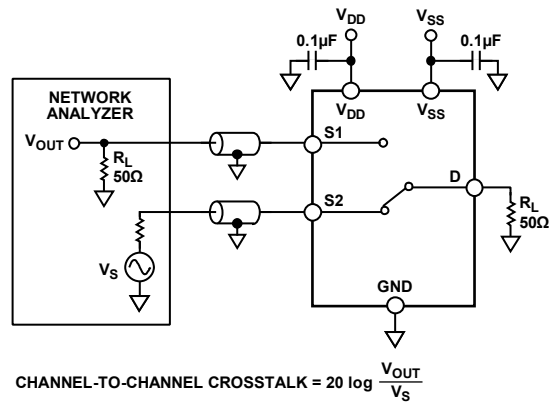

Figure 28. Channel-to-Channel Crosstalk

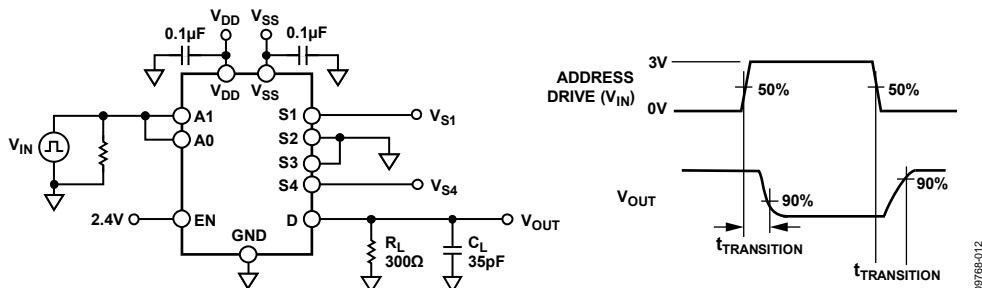

Figure 29. Address to Output Switching Times

09768-012

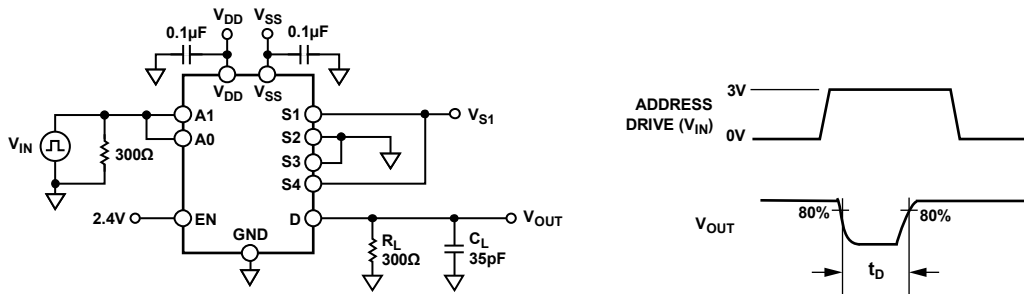

Figure 30. Break-Before-Make Time Delay, t_D

09768-013

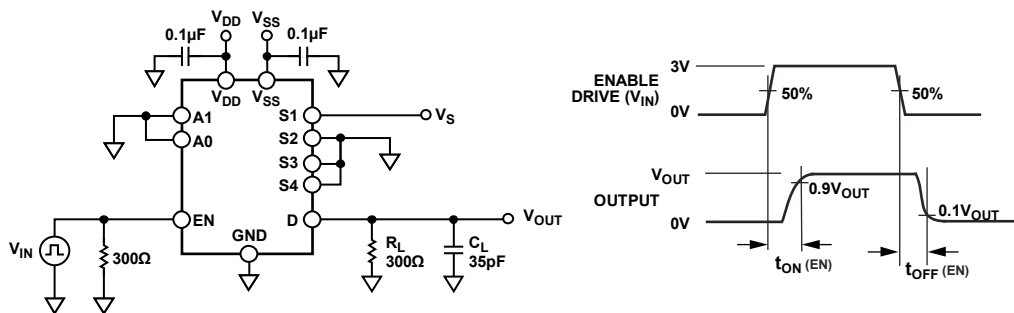

Figure 31. Enable-to-Output Switching Delay

09768-014

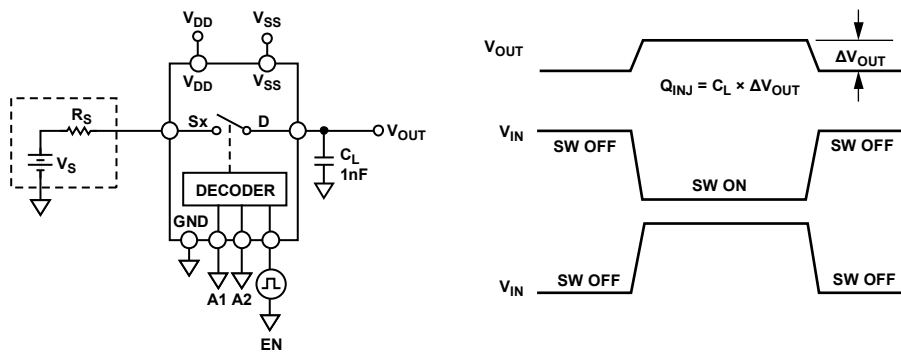

Figure 32. Charge Injection

09768-015

TERMINOLOGY

I_{DD}

The positive supply current.

I_{SS}

The negative supply current.

V_D, V_S

The analog voltage on Terminal D and Terminal S.

R_{ON}

The ohmic resistance between Terminal D and Terminal S.

R_{FLAT(ON)}

Flatness that is defined as the difference between the maximum and minimum value of on resistance measured over the specified analog signal range.

I_S (Off)

The source leakage current with the switch off.

I_D (Off)

The drain leakage current with the switch off.

I_D, I_S (On)

The channel leakage current with the switch on.

V_{INL}

The maximum input voltage for Logic 0.

V_{INH}

The minimum input voltage for Logic 1.

I_{INL}, I_{INH}

The input current of the digital input.

C_S (Off)

The off switch source capacitance, which is measured with reference to ground.

C_D (Off)

The off switch drain capacitance, which is measured with reference to ground.

C_D (On), C_S (On)

The on switch capacitance, which is measured with reference to ground.

C_{IN}

The digital input capacitance.

t_{TRANSITION}

The delay time between the 50% and 90% points of the digital input and switch-on condition when switching from one address state to another.

t_{ON} (EN)

The delay between applying the digital control input and the output switching on. See Figure 31.

t_{OFF} (EN)

The delay between applying the digital control input and the output switching off. See Figure 31.

Charge Injection

A measure of the glitch impulse transferred from the digital input to the analog output during switching.

Off Isolation

A measure of unwanted signal coupling through an off switch.

Crosstalk

A measure of unwanted signal that is coupled through from one channel to another as a result of parasitic capacitance.

Bandwidth

The frequency at which the output is attenuated by 3 dB.

On Response

The frequency response of the on switch.

Insertion Loss

The loss due to the on resistance of the switch.

ACPSRR (AC Power Supply Rejection Ratio)

The ratio of the amplitude of signal on the output to the amplitude of the modulation. This is a measure of the ability of the device to avoid coupling noise and spurious signals that appear on the supply voltage pins to the output of the switch. The dc voltage on the device is modulated by a sine wave of 0.62 V p-p.

TRENCH ISOLATION

In the ADG5204, an insulating oxide layer (trench) is placed between the NMOS and the PMOS transistors of each CMOS switch. Parasitic junctions, which occur between the transistors in junction isolated switches, are eliminated, and the result is a completely latch-up proof switch.

In junction isolation, the N and P wells of the PMOS and NMOS transistors form a diode that is reverse-biased under normal operation. However, during overvoltage conditions, this diode can become forward-biased. A silicon controlled rectifier (SCR) type circuit is formed by the two transistors causing a significant amplification of the current that, in turn, leads to latch-up. By using trench isolation, this diode is removed, and the result is a latch-up proof switch.

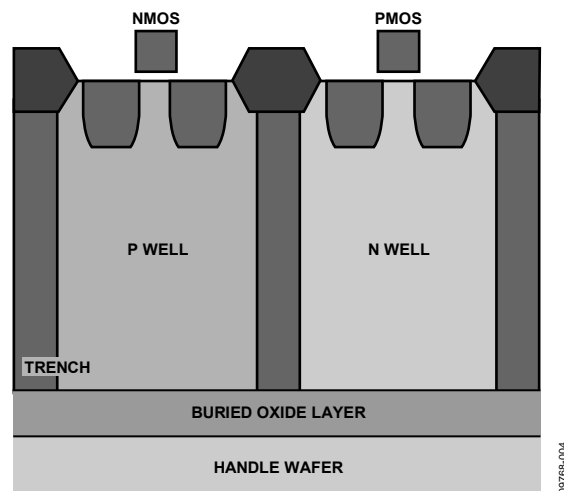
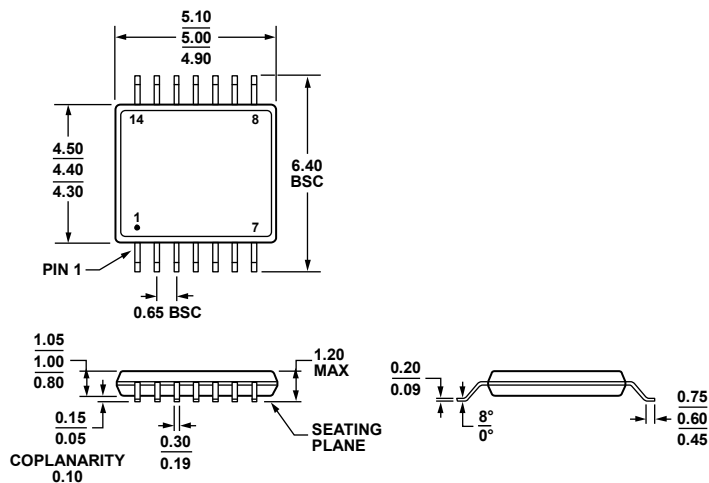

Figure 33. Trench Isolation

APPLICATIONS INFORMATION

The ADG52xx family of switches and multiplexers provide a robust solution for instrumentation, industrial, automotive, aerospace, and other harsh environments that are prone to latch-up, which is an undesirable high current state that can lead to device failure and persists until the power supply is turned off. The ADG5204 high voltage multiplexer allows single-supply operation from 9 V to 40 V and dual-supply operation from ± 9 V to ± 22 V.

OUTLINE DIMENSIONS



COMPLIANT TO JEDEC STANDARDS MO-153-AB-1

Figure 34. 14-Lead Thin Shrink Small Outline Package [TSSOP] (RU-14)
Dimensions shown in millimeters

061908-A

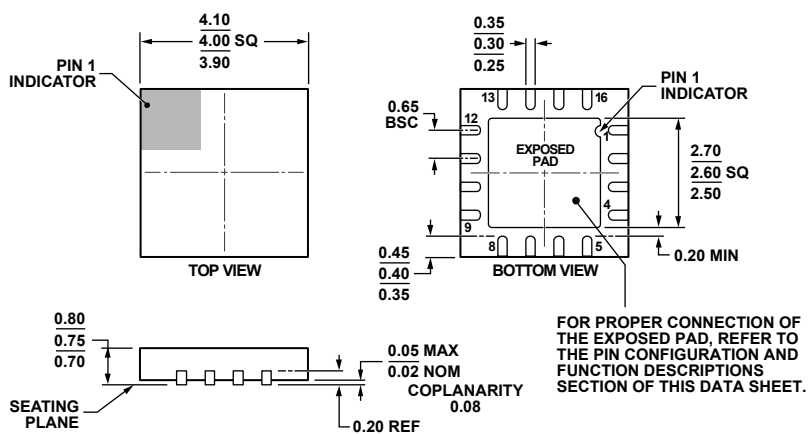

COMPLIANT TO JEDEC STANDARDS MO-220-WGGC.

Figure 35. 16-Lead Lead Frame Chip Scale Package [LFCSP_WQ] 4 mm x 4 mm Body, Very Very Thin Quad (CP-16-17)
Dimensions shown in millimeters

08-16-2010-C

ORDERING GUIDE

Model ¹	Temperature Range	Package Description	Package Option
ADG5204BRUZ	-40°C to +125°C	14-Lead Thin Shrink Small Outline Package [TSSOP]	RU-14
ADG5204BRUZ-RL7	-40°C to +125°C	14-Lead Thin Shrink Small Outline Package [TSSOP]	RU-14
ADG5204BCPZ-RL7	-40°C to +125°C	16-Lead Lead Frame Chip Scale Package [LFCSP_WQ]	CP-16-17

¹ Z = RoHS Compliant Part.

ADG5204

NOTES