



Typical unit

FEATURES

- 3.3 Volts DC fixed output up to 50 Amps
- Industry standard quarter brick 2.3" x 1.45" x 0.40" open frame package
- Wide range 36 to 75 Vdc input voltages with 2250 Volt Basic isolation
- Double lead-free assembly and attachment for RoHS standards
- Up to 165 Watts total output power
- High efficiency synchronous rectifier topology
- Stable no-load operation with no required external components
- Operating temperature range -40 to +85° C. with no heat sink required
- Meets UL/EN 60950-1, CSA-C22.2 No. 60950-1, safety approvals, 2nd Edition
- Extensive self-protection, current limiting and shut down features

PRODUCT OVERVIEW

Unique among quarter-brick DC/DC converters, the HPQ-3.3/50-D48 series offers very high output current (up to 50 Amps) in an industry standard "quarter brick" package requiring no heat sink. The HPQ-3.3/50-D48 series delivers up to 165 Watts fixed voltage output for printed circuit board mounting. Wide range inputs on the 2.3" x 1.45" x 0.40" converter are 36 to 75 Volts DC (48 Volts nominal), ideal for datacom and telecom systems. The fixed output voltage is regulated to within $\pm 1\%$ and may be trimmed within $\pm 10\%$ of nominal output.

Advanced automated surface mount assembly and planar magnetics deliver full magnetic and optical isolation with Basic protection up to 2250 Volts. To power digital systems, the outputs offer fast settling to current steps and tolerance of higher capacitive loads. Excellent ripple and noise specifications assure compatibility to CPU's, ASIC's, programmable logic and FPGA's. No minimum load is required. For systems needing controlled startup/

shutdown, an external remote On/Off control may use either positive or negative polarity. Remote Sense inputs compensate for resistive line drops at high currents.

A wealth of self-protection features avoid problems with both the converter and external circuits. These include input undervoltage lockout and overtemperature shutdown using an on-board temperature sensor. Excessive overcurrents limit their power using the "hiccup" autorestart technique and the outputs may be short-circuited indefinitely. Additional safety features include output overvoltage protection and reverse conduction elimination. The synchronous rectifier topology offers high efficiency for minimal heat buildup and "no heat sink" operation. The HPQ-3.3/50-D48 series meets safety certifications to UL/EN/IEC/CSA 60950-1, 2nd Edition and RFI/EMI conducted/radiated emission compliance to EN55022-CISPR22 with external filter.

APPLICATIONS

- Embedded systems, datacom and telecom installations
- Disk farms, data centers and cellular repeater sites
- Remote sensor systems, dedicated controllers
- Instrumentation systems, R&D platforms, automated test fixtures
- Data concentrators, voice forwarding and speech processing systems

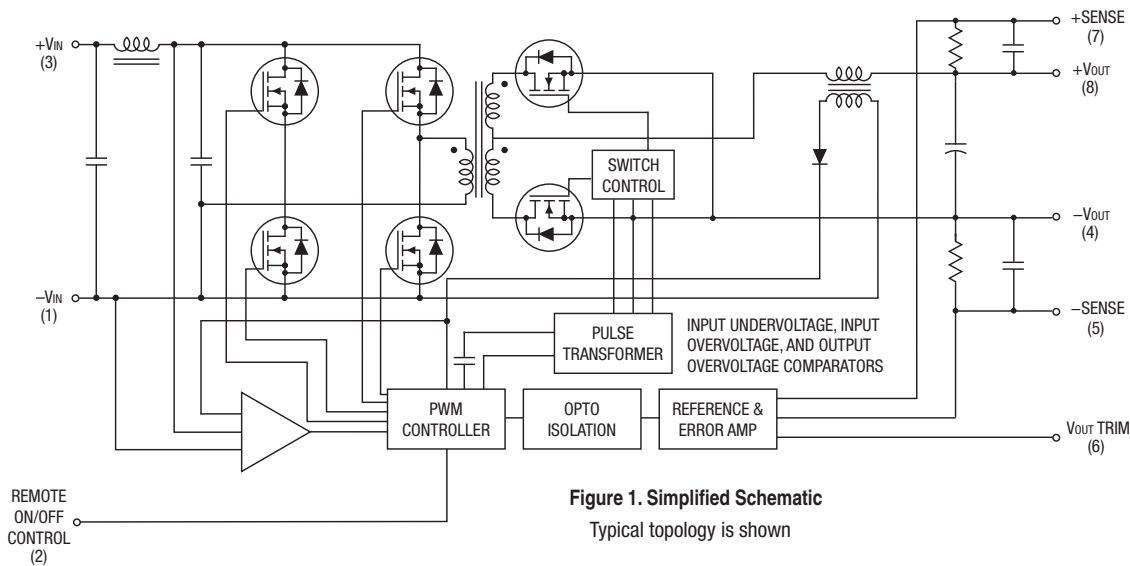

Figure 1. Simplified Schematic
Typical topology is shown



ORDERING GUIDE ①																
Root Model ①	Output						Input				Efficiency		Package			
	V _{OUT} (Volts)	I _{OUT} (Amps, max.)	Power (Watts)	R/N (mV pk-pk)		Regulation (Max.) ②		V _{IN} Nom. (Volts)	Range (Volts)	I _{IN} no load (mA)	I _{IN} full load (Amps)	Min.	Typ.	Dimensions (inches)	Dimensions (mm)	Pinout
				Typ.	Max.	Line	Load									
HPQ-3.3/50-D48	3.3	50	165	50	100	±0.2%	±0.2%	48	36-75	80	3.82	88%	90%	1.45x2.3x0.40	36.8x58.4x10.2	P32

① Please refer to the part number structure for additional ordering information and options.

② All specifications are at nominal line voltage and full load, +25 deg.C. unless otherwise noted. See detailed specifications. Output capacitors are 1 µF ceramic || 10 µF electrolytic with no input caps. These caps are necessary for our test equipment and may not be needed for your application.

MECHANICAL SPECIFICATIONS

Dimensions are in inches (mm) shown for ref. only.

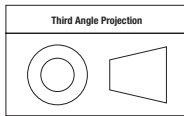

Tolerances (unless otherwise specified):
 .XX ± 0.02 (0.5)
 .XXX ± 0.010 (0.25)
 Angles ± 2°

Components are shown for reference only.

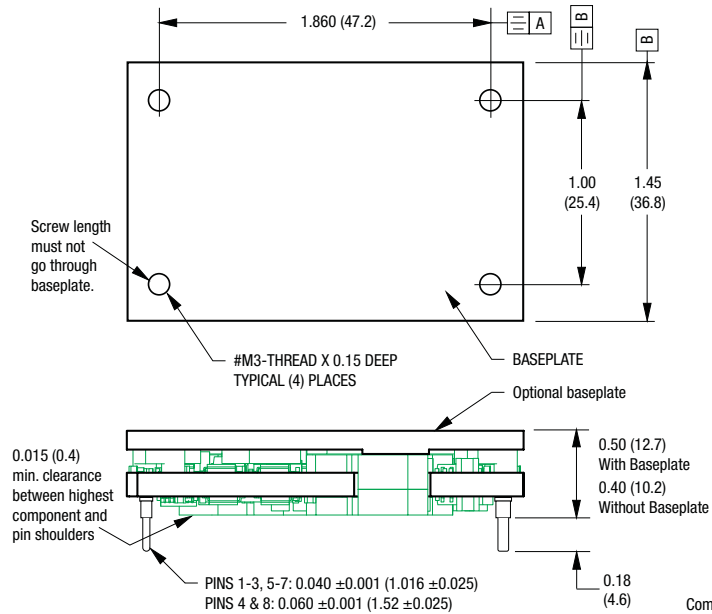

Component locations are typical and may vary between models.

DOSA-Compatible I/O Connections (pin side view)			
Pin	Function P32	Pin	Function P32
1	Neg. Input*	5	Neg. Sense
2	Remote On/Off Control	6	Output Trim
3	Pos. Input*	7	Pos. Sense
4	Neg. Output	8	Pos. Output

* These converters are pin-for-pin/plug-compatible to competitive units. Other units may use different pin numbering or alternate outline views. When laying out your PC board, follow the pin FUNCTION. DOSA designates Pin 1 as +Input and Pin 3 as -Input.

Important! *Always* connect the sense pins. If they are not connected to a remote load, wire each sense pin to its respective voltage output at the converter pins.

Standard pin length is shown. Please refer to the part number structure for alternate pin lengths.

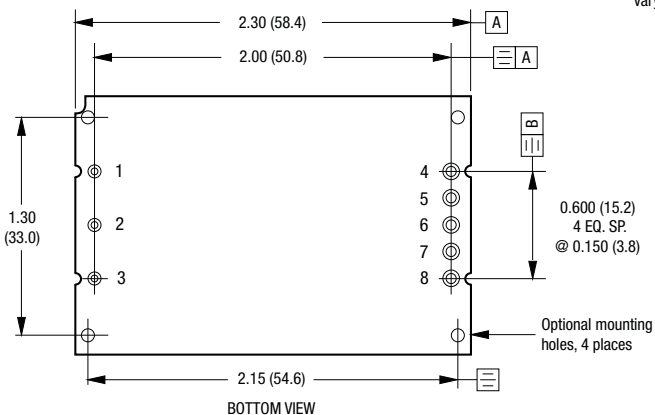

PART NUMBER STRUCTURE

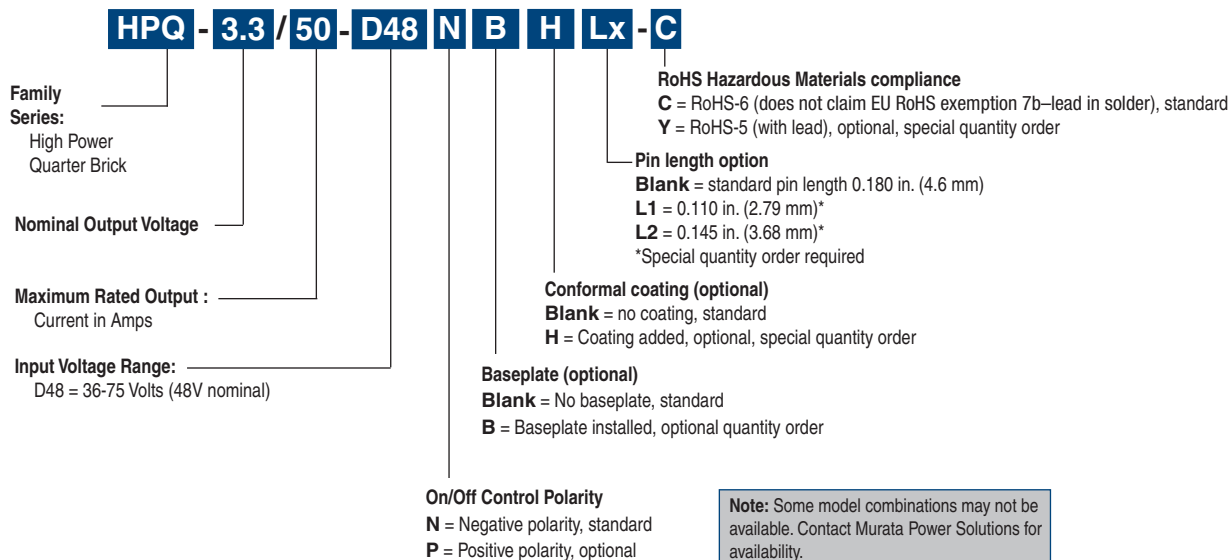

Performance and Functional Specifications

All specifications are typical unless noted. See Note 1.

Input	
Input Voltage Range	See Ordering Guide.
Recommended External Fuse	10 Amps fast blow
Start-Up Voltage	33.0 Volts
Undervoltage Shutdown	32.0 Volts
Overvoltage Shutdown	None, see application notes.
Reflected (Back) Ripple Current (Note 2)	20 mA pk-pk
Internal Input Filter Type	Pi-type
Reverse Polarity Protection (Note 15)	None. Install external fuse.
Input Current:	
Full Load Conditions	See Ordering Guide.
Inrush Transient	0.05 A ² Sec.
Shutdown Mode (Off, UV, OT)	10 mA
Output Short Circuit	50 mA
No Load, 3.3Vout	80 mA
Low Line (Vin=Vmin, 3.3Vout)	5.21 Amps
Remote On/Off Control (Note 5)	
Positive Logic ("P" suffix)	ON = +2.5 V. to +15 V. max. or open pin OFF = 0 to +1 V. max. or ground pin
Negative Logic ("N" suffix)	ON = -0.1 V. to +0.8 V. max. or ground pin OFF = +2.5 V. to +15 V. max. or open pin
Current	1 mA

Output	
Minimum Loading	No minimum load
Maximum Output Power	166.6 Watts
Accuracy (50% load)	±1 % of Vsetting. See note 16.
Overvoltage Protection (Note 7)	4 Volts
Temperature Coefficient	±0.02% per °C. of Vout range
Ripple/Noise (20 MHz bandwidth)	See Ordering Guide and note 8.
Line/Load Regulation (See Tech. Notes)	See Ordering Guide and note 10.
Efficiency	See Ordering Guide
Remote Sense Compensation	+10% max. deviation from output
Maximum Capacitive Loading, low ESR	10,000 µF max. See note 11.
Current Limit Inception (98% of Vout setting)	59 Amps (after warm up) See note 12.
Short Circuit Mode (Notes 6, 12)	
Short Circuit Current Output	5 Amps
Protection Method	Hiccup autorecovery upon overload removal. (See note 12)
Short Circuit Duration	Continuous, no damage (output shorted to ground)
Isolation	
Isolation Voltage	
Input to Output	2250 Vdc min.
Input to Baseplate	1500 Vdc min.
Baseplate to Output	1500 Vdc min.
Isolation Resistance	10 Megohms
Isolation Capacitance	1000 pF
Isolation Safety Rating	Basic insulation
Dynamic Characteristics	
Dynamic Load Response (see note 1)	200 µSec to within ±1% of final value. (50-75-50% load step)
Turn-On Time	10 mSec for Vout regulated
Remote On/Off Time	10 mSec for Vout regulated
Switching Frequency	400 ±40 KHz
Environmental	
Calculated MTBF (Note 4)	TBC
Operating Temperature Range (no baseplate)	-40 to +85 °C (with derating)
Maximum Baseplate Operating Temperature	+100 °C
Storage Temperature Range	-55 to +125 °C
Thermal Protection/Shutdown (Case temp. is measured in the center)	+115 °C
Relative Humidity	85%/+85 °C
Physical	
Outline Dimensions	See Mechanical Specifications
Weight (without baseplate)	1.06 ounces (30 grams)
Electromagnetic Interference (may require external filter)	Meets EN55022, CISPR22, Class B, conducted and radiated
Safety	Meets UL/cUL 60950-1 CSA-C22.2 No. 60950-1 IEC/EN 60950-1, 2nd Edition

Absolute Maximum Ratings	
Input Voltage	
Continuous	75 Volts max.
Transient, 100 mS max.	100 Volts max.
Output Power	166.6 Watts max.
On/Off Control	0V. min. to +15 V. max.
Input Reverse Polarity Protection	None. Install external fuse.
Output Current	Current-limited. Devices can withstand sustained short circuit without damage.
Storage Temperature	-55 to +125 °C
Lead Temperature	See soldering guidelines.

Absolute maximums are stress ratings. Exposure of devices to greater than any of these conditions may adversely affect long-term reliability. Proper operation under conditions other than those listed in the Performance/Functional Specifications Table is not implied nor recommended.

Specification Notes

- (1) All models are tested and specified with external 1110 μ F output capacitors and no external input capacitor. All capacitors are low ESR types. These capacitors are necessary to accommodate our test equipment and may not be required to achieve specified performance in your applications. All models are stable and regulate within spec under no-load conditions. All specifications are typical unless noted. General conditions for Specifications are +25 °C, V_{in} =nominal, V_{out} =nominal, full load. Adequate airflow must be supplied for extended testing under power.
- (2) Reflected Input Ripple Current is tested and specified over a 5 Hz to 20 MHz bandwidth. Input filtering is C_{in} =33 μ F, 100V, C_{bus} =220 μ F, 100V electrolytic, L_{bus} =12 μ H.
- (3) Note that Maximum Power Derating curves indicate an average current at nominal input voltage. At higher temperatures and/or lower airflow, the DC/DC converter will tolerate brief full current outputs if the total RMS current over time does not exceed the Derating curve. All Derating curves are presented at sea level altitude. Be aware of reduced power dissipation with increasing density altitude.
- (4) Mean Time Before Failure is calculated using the Telcordia (Belcore) SR-332 Method 1, Case 3, ground fixed conditions, T_{pcb} =+25 °C, full output load, natural air convection.
- (5) The On/Off Control is normally controlled by a switch, relay or open collector or open drain transistor. But it may also be driven with external logic or by applying appropriate external voltages which are referenced to Input Common.
- (6) Short circuit shutdown begins when the output voltage degrades approximately 2% from the selected setting.
- (7) The output is not intended to sink appreciable reverse current. This may damage the outputs.
- (8) Output noise may be further reduced by adding an external filter. See I/O Filtering and Noise Reduction.
- (9) All models are fully operational and meet published specifications, including "cold start" at -40 °C. Maximum power requires that the package temperature of all on-board components must never exceed +128°C.
- (10) Regulation specifications describe the deviation as the line input voltage or output load current is varied from a nominal midpoint value to either extreme.
- (11) The converter is normally specified with the Input/Output filtering listed in Note 1. Higher capacitive load will reduce noise but at the expense of delayed settling time, extended turn-on time and slower transient response. Use only as much output filtering as needed and no more. Thoroughly test your system under full load with all components installed. Low ESR capacitors with high capacitance may degrade dynamic performance.
- (12) "Hiccup" overcurrent operation repeatedly attempts to restart the converter with a brief, full-current output. If the overcurrent condition still exists, the restart current will be removed and then tried again. This short current repeating pulse prevents overheating and damaging the converter. Output current limit and short circuit protection is non-latching. Once the fault is removed, the converter immediately recovers normal operation.
- (13) Do not exceed maximum power specifications when adjusting the output trim.
- (14) At zero output current, the output may contain low frequency components which exceed the ripple specification. The output may be operated indefinitely with no load.
- (15) Input Fusing: To ensure reverse input protection, always connect an external input fast-blow fuse in series with the +Vin input.
- (16) Output accuracy is dependent on user-supplied trim resistors. To achieve high accuracy, use \pm 1% or better tolerance metal-film resistors.
- (17.) Always connect the sense pins. If they are not connected to a remote load, wire each sense pin to its respective voltage output at the converter pins.

Soldering Guidelines

Murata Power Solutions recommends the specifications below when installing these converters. These specifications vary depending on the solder type. Exceeding these specifications may cause damage to the product. Your production environment may differ; therefore please thoroughly review these guidelines with your process engineers.

Wave Solder Operations for through-hole mounted products (THMT)			
For Sn/Ag/Cu based solders:		For Sn/Pb based solders:	
Maximum Preheat Temperature	115° C.	Maximum Preheat Temperature	105° C.
Maximum Pot Temperature	270° C.	Maximum Pot Temperature	250° C.
Maximum Solder Dwell Time	7 seconds	Maximum Solder Dwell Time	6 seconds

Technical Notes

Removal of Soldered Converters from Printed Circuit Boards

Should removal of the converter from its soldered connection be needed, thoroughly de-solder the pins using solder wicks or de-soldering tools. At no time should any prying or leverage be used to remove converters that have not been properly de-soldered first.

Input Source Impedance

These converters must be driven from a low ac-impedance input source. The DC/DC's performance and stability can be compromised by the use of highly inductive source impedances. The input circuit shown in Figure 2 is a practical solution that can be used to minimize the effects of inductance in the input traces. For optimum performance, components should be mounted close to the DC/DC converter.

I/O Filtering, Input Ripple Current, and Output Noise

All models in this Series are tested/specified for input ripple current (also called input reflected ripple current) and output noise using the circuits and layout shown in Figures 2 and 3. External input capacitors (C_{IN} in Figure 2) serve primarily as energy-storage elements.

They should be selected for bulk capacitance (at appropriate frequencies), low ESR, and high rms-ripple-current ratings. The switching nature of DC/DC converters requires that dc voltage sources have low ac impedance as highly inductive source impedance can affect system stability. In Figure 2, C_{BUS} and L_{BUS} simulate a typical dc voltage bus. Your specific system configuration may necessitate additional considerations.

In critical applications, output ripple/noise (also referred to as periodic and random deviations or PARD) can be reduced below specified limits using filtering techniques, the simplest of which is the installation of additional external output capacitors. Output capacitors function as true filter elements and should be selected for bulk capacitance, low ESR, and appropriate frequency response. In Figure 3, the two copper strips simulate real-world pcb impedances between the power supply and its load. Scope measurements should be made using BNC connectors or the probe ground should be less than 1/2 inch and soldered directly to the test circuit.

All external capacitors should have appropriate voltage ratings and be located as close to the converter as possible. Temperature variations for all relevant parameters should be taken into consideration.

The most effective combination of external I/O capacitors will be a function of line voltage and source impedance, as well as particular load and layout conditions.

Start-Up Threshold and Undervoltage Shutdown

Under normal start-up conditions, these converters will not begin to regulate properly until the ramping input voltage exceeds the Start-Up Threshold. Once operating, devices will turn off when the applied voltage drops below the Undervoltage Shutdown point. Devices will remain off as long as the undervoltage condition continues. Units will automatically re-start when the applied voltage is brought back above the Start-Up Threshold. The hysteresis built into this function avoids an indeterminate on/off condition at a single input voltage. See Performance/Functional Specifications table for actual limits.

Start-Up Time

The V_{IN} to V_{OUT} Start-Up Time is the interval between the point at which a ramping input voltage crosses the Start-Up Threshold voltage and the point at which the fully loaded output voltage enters and remains within its specified regulation band. Actual measured times will vary with input source impedance, external input capacitance, and the slew rate and final value of the input voltage as it appears to the converter. The On/Off to V_{OUT} start-up time assumes that the converter is turned off via the Remote On/Off Control with the nominal input voltage already applied.

On/Off Control

The primary-side, Remote On/Off Control function can be specified to operate with either positive or negative polarity. Positive-polarity devices ("P" suffix) are enabled when the on/off pin is left open or is pulled high. Positive-polarity devices are disabled when the on/off pin is pulled low (with respect to -Input). Negative-polarity devices are off when the on/off pin is high and on when the on/off pin is pulled low. See Figure 4.

Dynamic control of the remote on/off function is best accomplished with a mechanical relay or an open-collector/open-drain drive circuit (optically isolated if appropriate). The drive circuit should be able to sink appropriate current (see Performance Specifications) when activated and withstand appropriate voltage when deactivated.

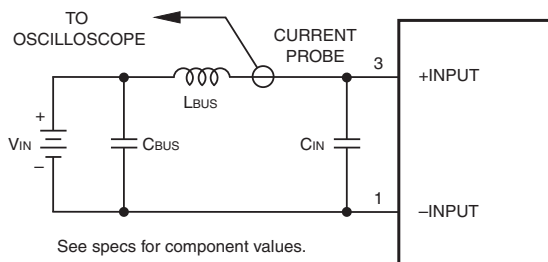

Figure 2. Measuring Input Ripple Current

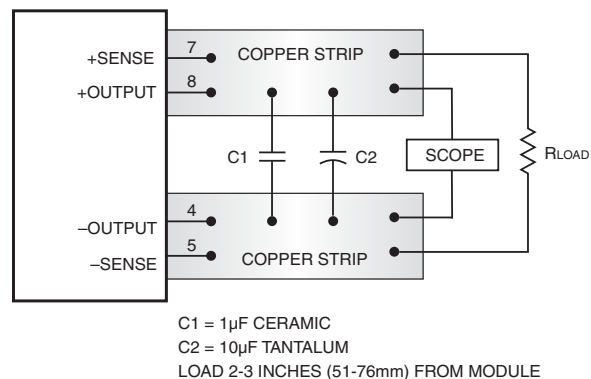

Figure 3. Measuring Output Ripple/Noise (PARD)

Isolated High Power Quarter Brick DC/DC Converters

Sense Input

Note: The sense and V_{OUT} lines are internally connected through low-value resistors. Nevertheless, if sense is not used for remote regulation, the user *must* connect + sense to + V_{OUT} and -sense to -V_{OUT} at the converter pins. Sense is intended to correct small output accuracy errors caused by the resistive ohmic drop in output wiring as output current increases. This output drop (the difference between Sense and V_{OUT} when measured at the converter) should not be allowed to exceed 0.5V.

Sense is connected at the load and corrects for resistive errors only. Be careful where it is connected. Any long, distributed wiring and/or significant inductance introduced into the Sense control loop can adversely affect overall system stability. If in doubt, test the application, and observe the DC/DC's output transient response during step loads. There should be no appreciable ringing or oscillation. You may also adjust the output trim slightly to compensate for voltage loss in any external filter elements. Do not exceed maximum power ratings.

Current Limiting

When power demands from the output falls within the current limit inception range for the rated output current, the DC/DC converter will go into a current limiting mode. In this condition the output voltage will decrease proportionately with increases in output current, thereby maintaining a somewhat constant power dissipation. This is commonly referred to as power limiting. Current limit inception is defined as the point where the full-power output voltage falls below the specified tolerance. If the load current being drawn from the converter is significant enough, the unit will go into a short circuit condition. See "Short Circuit Condition."

Short Circuit Condition

When a converter is in current limit mode the output voltages will drop as the output current demand increases. If the output voltage drops too low, the magnetically coupled voltage used to develop primary side voltages will also drop, thereby shutting down the PWM controller. Following the specified time-out period, the PWM will restart, causing the output voltages to begin ramping to their appropriate values. If the short-circuit condition persists, another shutdown cycle will be initiated. This on/off cycling is referred to as "hiccup" mode. The hiccup cycling reduces the average output current, thereby preventing internal temperatures from rising to excessive levels. This converter is capable of enduring an indefinite short circuit output condition.

Thermal Shutdown

These converters are equipped with thermal-shutdown circuitry. If the internal temperature of the DC/DC converter rises above the designed operating

temperature (See Performance Specifications), a precision temperature sensor will power down the unit. When the internal temperature decreases below the threshold of the temperature sensor, the unit will self start.

Output Overvoltage Protection

The output voltage is monitored for an overvoltage condition via magnetic coupling to the primary side. If the output voltage rises to a fault condition, which could be damaging to the load circuitry (see Performance Specifications), the sensing circuitry will power down the PWM controller causing the output voltage to decrease. Following a time-out period the PWM will restart, causing the output voltage to ramp to its appropriate value. If the fault condition persists, and the output voltages again climb to excessive levels, the overvoltage circuitry will initiate another shutdown cycle. This on/off cycling is referred to as "hiccup" mode.

Input Reverse-Polarity Protection

If the input-voltage polarity is accidentally reversed, an internal diode will become forward biased and likely draw excessive current from the power source. If the source is not current limited or the circuit appropriately fused, it could cause permanent damage to the converter.

Input Fusing

Certain applications and/or safety agencies may require the installation of fuses at the inputs of power conversion components. Fuses should also be used if the possibility of a sustained, non-current-limited, input-voltage polarity reversal exists. For these converters, fast-blow fuses are recommended with values no greater than twice the maximum input current.

Trimming Output Voltage

These converters have a trim capability that enables users to adjust the output voltage over a limited range (refer to the trim equations). Adjustments to the output voltage can be accomplished with a single fixed resistor as shown in Figures 5 and 6. A single fixed resistor can increase or decrease the output voltage depending on its connection. Resistors should be located close to the converter and have TCR's less than 100ppm/°C to minimize sensitivity to changes in temperature. If the trim function is not used, leave the trim pin open.

On standard units, a single resistor connected from the Trim pin to the +Sense will increase the output voltage. A resistor connected from the Trim Pin to the -Sense will decrease the output voltage.

Trim adjustments greater than the specified trim range can have an adverse affect on the converter's performance and are not recommended. Excessive voltage differences between V_{OUT} and Sense, in conjunction with trim adjustment of the output voltage, can cause the overvoltage protection circuitry to activate (see Performance Specifications for overvoltage limits).

Temperature/power derating is based on maximum output current and voltage at the converter's output pins. Use of the trim and sense functions can cause output voltages to increase, thereby increasing output power beyond the converter's specified rating, or cause output voltages to climb into the output overvoltage region. Therefore:

$$(V_{out \text{ at pins}}) \times (I_{out}) \leq \text{rated output power}$$

The Trim pin is a relatively high impedance node that can be susceptible to noise pickup when connected to long conductors in noisy environments.

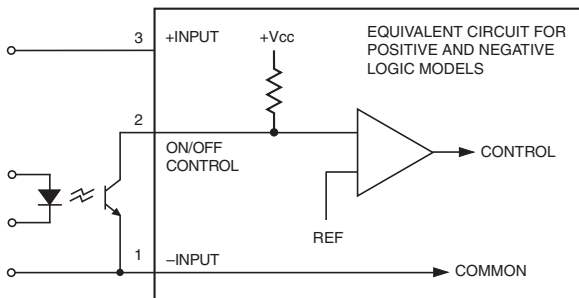

Figure 4. Driving the Remote On/Off Control Pin

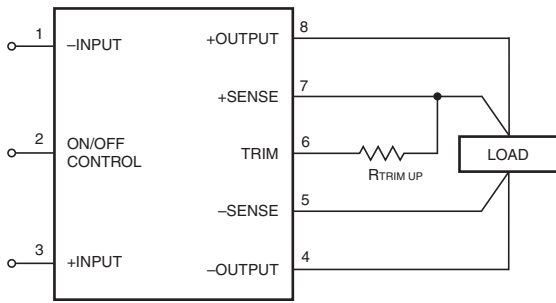

Figure 5. Trim Connections To Increase Output Voltages Using Fixed Resistors

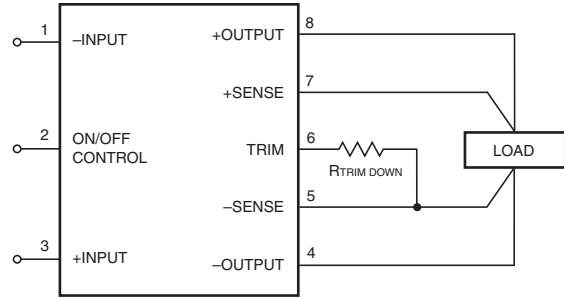

Figure 6. Trim Connections To Decrease Output Voltages Using Fixed Resistors

Trim Up	Trim Down
HPQ-3.3/50-D48	
$R_{T_UP} (k\Omega) = \frac{16.863(1+\Delta)}{1.225 \times \Delta} - \frac{5.11}{\Delta} - 10.22$	$R_{T_DOWN} (k\Omega) = \frac{5.11}{\Delta} - 10.22$

where Δ is the absolute value of $\left| \frac{3.3 - V_{OUT}}{3.3} \right|$
 (Δ is always positive)

TYPICAL PERFORMANCE CURVES

Efficiency vs Line Voltage and Load Current @ +25°C

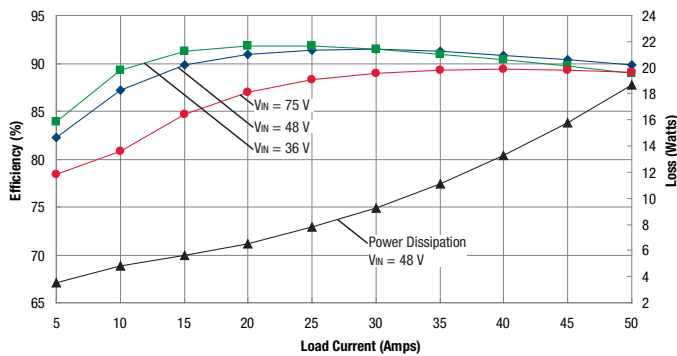

Maximum Current Temperature Derating (Vin=48V, no baseplate, longitudinal air flow)

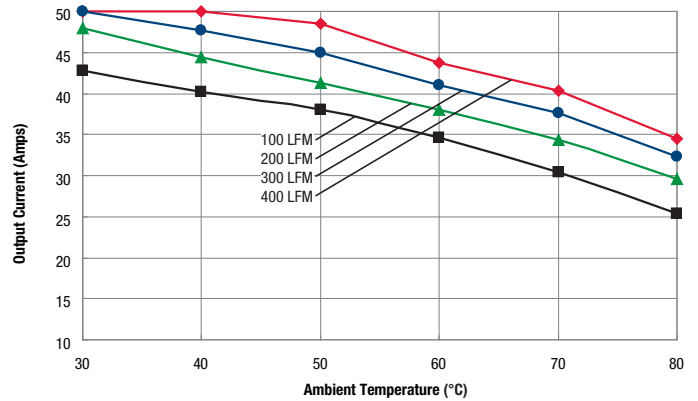

Maximum Current Temperature Derating (Vin=48V, with baseplate, longitudinal air flow)

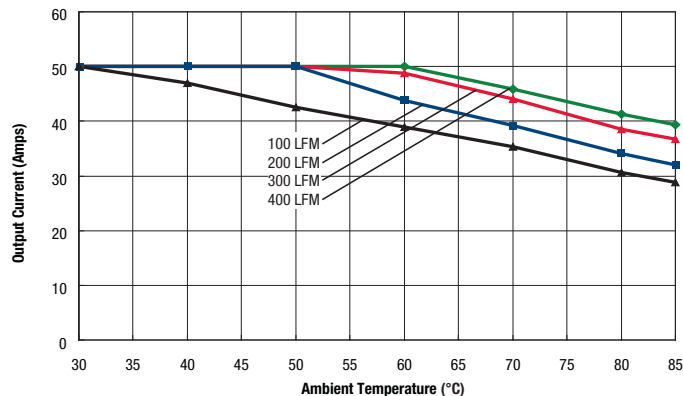

Transient Response

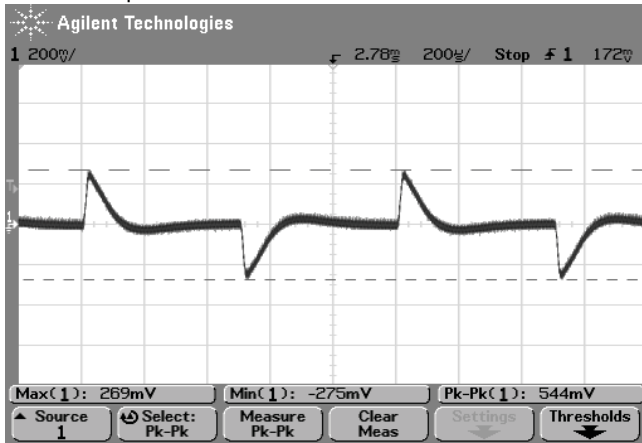

Transient Response (25% Load Step)

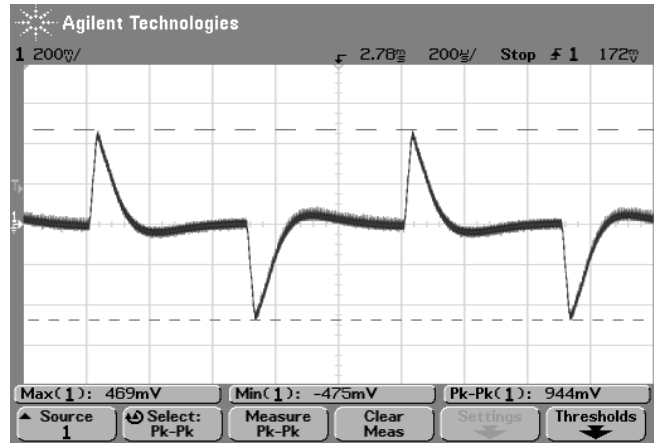

Transient Response (50% Load Step)

Enable Start-up

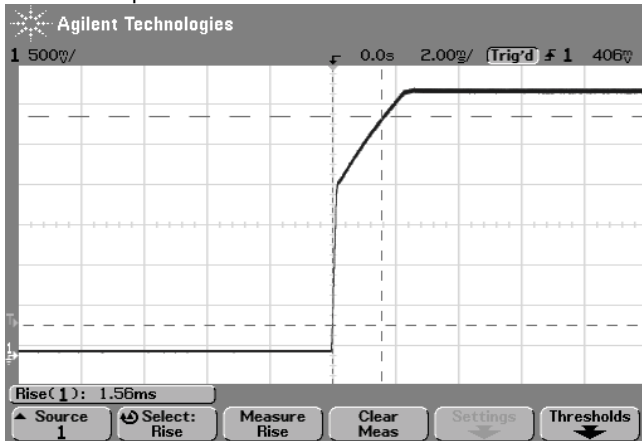

Enable Start-up (Vin=48V Iout=0A)

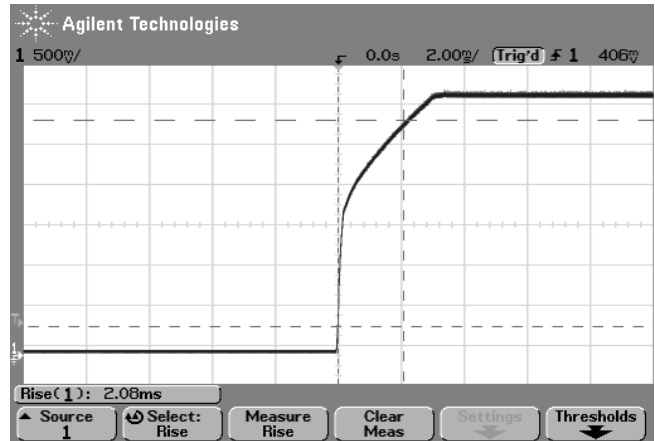

Enable Start-up (Vin=48V Iout=50A)

Ripple and Noise (1µF Ceramic plus 10µF Tantalum)

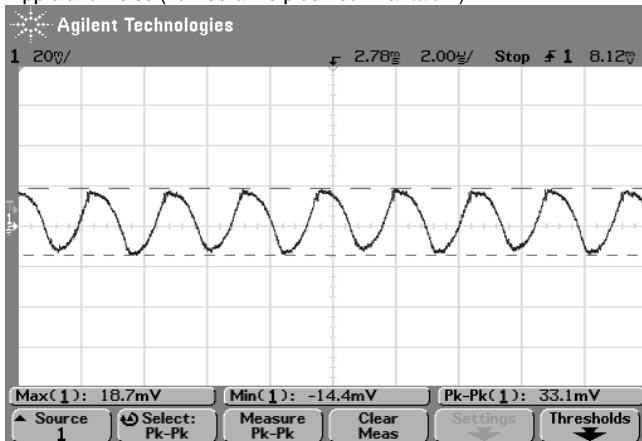

Ripple Waveform (Vin=48V Iout=0A)

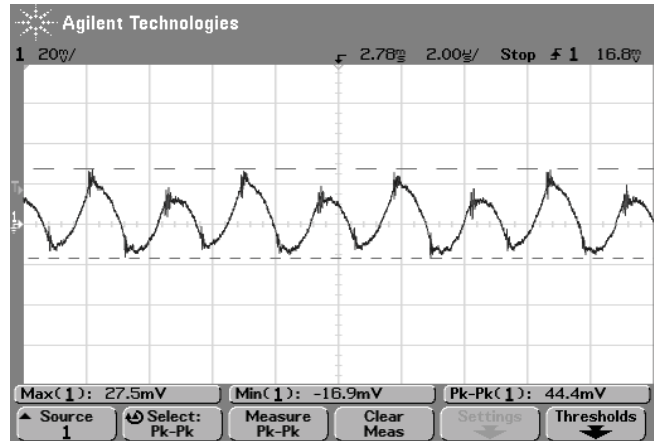

Ripple Waveform (Vin=48V Iout=50A)

On/Off Enable Control Ground Bounce Protection

To improve reliability, if you use a small signal transistor or other external circuit to select the Remote On/Off control, make sure to return the LO side directly to the -Vin power input on the DC/DC converter. To avoid ground bounce errors, do not connect the On/Off return to a distant ground plane or current-carrying bus. If necessary, run a separate small return wire directly to the -Vin terminal. There is very little current (typically 1-5 mA) on the On/Off control however, large current changes on a return ground plane or ground bus can accidentally trigger the converter on or off. If possible, mount the On/Off transistor or other control circuit adjacent to the converter.

NOTICE—Please use only this customer data sheet as product documentation when laying out your printed circuit boards and applying this product into your application. Do NOT use other materials as official documentation such as advertisements, product announcements, or website graphics.

We strive to have all technical data in this customer data sheet highly accurate and complete. This customer data sheet is revision-controlled and dated. The latest customer data sheet revision is normally on our website (www.murata-ps.com) for products which are fully released to Manufacturing. Please be especially careful using any data sheets labeled "Preliminary" since data may change without notice.

The pinout (Pxx) and case (Cxx) designations (typically P65 or C59) refer to a generic family of closely related information. It may not be a single pinout or unique case outline. Please be aware of small details (such as Sense pins, Power Good pins, etc.) or slightly different dimensions (baseplates, heat sinks, etc.) which may affect your application and PC board layouts. Study the Mechanical Outline drawings, Input/Output Connection table and all footnotes very carefully. Please contact Murata Power Solutions if you have any questions.

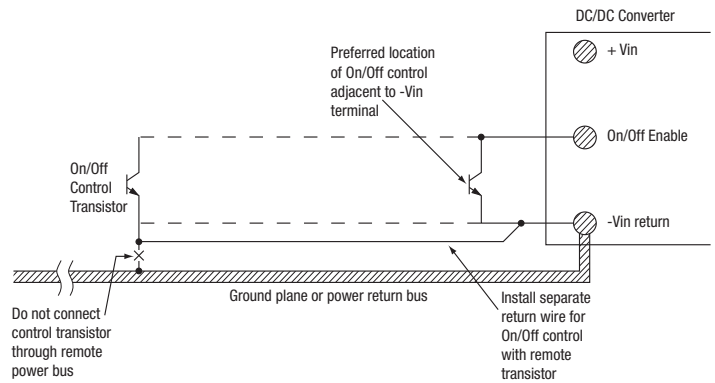

Figure 7. On/Off Enable Control Ground Bounce Protection