



Integrated Device Technology, Inc.

CMOS DUAL-PORT RAM
16K (2K x 8-BIT)

IDT7132SA/LA
IDT7142SA/LA

T-46-23-12

FEATURES:

- High-speed access
 - Military: 25/30/35/45/55/70/90/100/120ns (max.)
 - Commercial: 20/25/30/35/45/55/70/90/100ns (max.)
- Low-power operation
 - IDT7132/42SA
Active: 325mW (typ.)
Standby: 5mW (typ.)
 - IDT7132/42LA
Active: 325mW (typ.)
Standby: 1mW (typ.)
- Fully asynchronous operation from either port
- MASTER IDT7132 easily expands data bus width to 16-or-more bits using SLAVE IDT7142
- On-chip port arbitration logic (IDT7132 only)
- **BUSY** output flag on IDT7132; **BUSY** input on IDT7142
- Battery backup operation —2V data retention
- TTL-compatible, single 5V ±10% power supply
- Available in popular hermetic and plastic packages
- Military product compliant to MIL-STD, Class B
- Standard Military Drawing # 5962-87002
- Industrial temperature range (-40°C to +85°C) is available, tested to military electrical specifications

DESCRIPTION:

The IDT7132/IDT7142 are high-speed 2K x 8 dual-port static RAMs. The IDT7132 is designed to be used as a stand-alone 8-bit dual-port RAM or as a "MASTER" dual-port RAM together with the IDT7142 "SLAVE" dual-port in 16-bit-or-more word width systems. Using the IDT MASTER/SLAVE dual-port RAM approach in 16-or-more-bit memory system applications results in full-speed, error-free operation without the need for additional discrete logic.

Both devices provide two independent ports with separate control, address, and I/O pins that permit independent, asynchronous access for reads or writes to any location in memory. An automatic power down feature, controlled by \overline{CE} permits the on-chip circuitry of each port to enter a very low standby power mode.

Fabricated using IDT's CEMOS™ high-performance technology, these devices typically operate on only 325mW of power at maximum access times as fast as 20ns. Low-power (LA) versions offer battery backup data retention capability, with each dual-port typically consuming 200μW from a 2V battery.

The IDT7132/7142 devices are packaged in a 48-pin sidebrake or plastic DIPs, 48- or 52-pin LCCs, 52-pin PLCCs, and a 48-lead flatpacks. Military grade product is manufactured in compliance with the latest revision of MIL-STD-883, Class B.

FUNCTIONAL BLOCK DIAGRAM

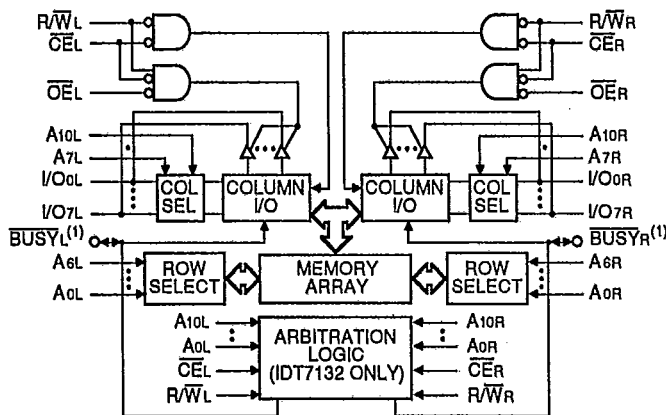

2692 drw 01

NOTE:
1. IDT7132 (MASTER): **BUSY** is open drain output and requires pullup resistor.
IDT7142 (SLAVE): **BUSY** is input.

CEMOS is a trademark of Integrated Device Technology, Inc.

MILITARY AND COMMERCIAL TEMPERATURE RANGES

APRIL 1992

PIN CONFIGURATIONS

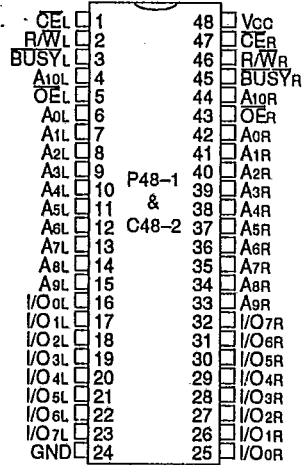

DIP TOP VIEW 2692 drw 02

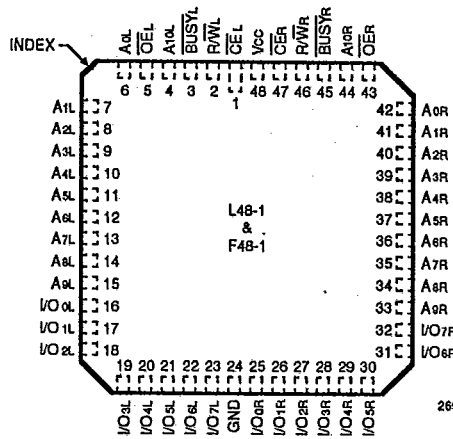

48-PIN LCC/FLATPACK TOP VIEW 2692 drw 03

ABSOLUTE MAXIMUM RATINGS⁽¹⁾

Symbol	Rating	Commercial	Military	Unit
V _{TERM} ⁽²⁾	Terminal Voltage with Respect to GND	-0.5 to +7.0	-0.5 to +7.0	V
T _A	Operating Temperature	0 to +70	-55 to +125	°C
T _{BIAS}	Temperature Under Bias	-55 to +125	-65 to +135	°C
T _{STG}	Storage Temperature	-55 to +125	-65 to +150	°C
I _{OUT}	DC Output Current	50	50	mA

- NOTE: 2692 tbi 01
- Stresses greater than those listed under ABSOLUTE MAXIMUM RATINGS may cause permanent damage to the device. This is a stress rating only and functional operation of the device at these or any other conditions above those indicated in the operational sections of the specification is not implied. Exposure to absolute maximum rating conditions for extended periods may affect reliability.
 - V_{TERM} must not exceed V_{CC} + 0.5V.

RECOMMENDED DC OPERATING CONDITIONS

Symbol	Parameter	Min.	Typ.	Max.	Unit
V _{CC}	Supply Voltage	4.5	5.0	5.5	V
GND	Supply Voltage	0	0	0	V
V _{IH}	Input High Voltage	2.2	—	6.0 ⁽²⁾	V
V _{IL}	Input Low Voltage	-0.5 ⁽¹⁾	—	0.8	V

- NOTE: 2692 tbi 02
- V_{IL} (min.) = -3.0V for pulse width less than 20ns.
 - V_{TERM} must not exceed V_{CC} + 0.5V.

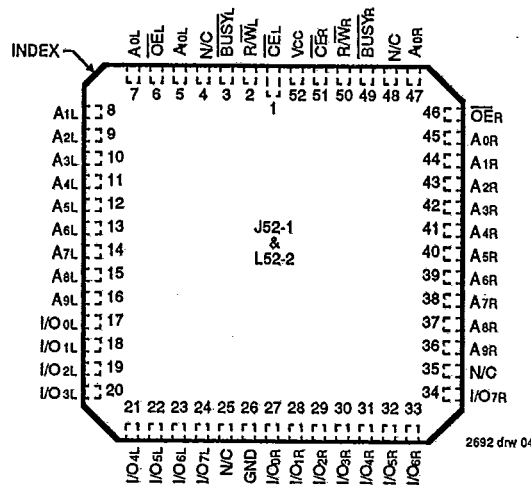

52-PIN LCC/PLCC TOP VIEW 2692 drw 04

RECOMMENDED OPERATING TEMPERATURE AND SUPPLY VOLTAGE

Grade	Ambient Temperature	GND	V _{CC}
Military	-55°C to +125°C	0V	5.0V ± 10%
Commercial	0°C to +70°C	0V	5.0V ± 10%

2692 tbi 03

T-46-23-12

DC ELECTRICAL CHARACTERISTICS OVER THE
OPERATING TEMPERATURE AND SUPPLY VOLTAGE RANGE (V_{CC} = 5.0V ± 10%)

Symbol	Parameter	Test Conditions	IDT7132SA IDT7142SA		IDT7132LA IDT7142LA		Unit
			Min.	Max.	Max.	Max.	
I _I	Input Leakage Current ⁽⁹⁾	V _{CC} = 5.5V, V _{IN} = 0V to V _{CC}	—	10	—	5	μA
I _O	Output Leakage Current	$\overline{CE} = V_{IH}$, V _{OUT} = 0V to V _{CC}	—	10	—	5	μA
V _{OL}	Output Low Voltage (V _{O0} -V _{O7})	I _{OL} = 4mA	—	0.4	—	0.4	V
V _{OL}	Open Drain Output Low Voltage (BUSY)	I _{OL} = 16mA	—	0.5	—	0.5	V
V _{OH}	Output High Voltage	I _{OH} = -4mA	2.4	—	2.4	—	V

2692 tbl 04

DC ELECTRICAL CHARACTERISTICS OVER THE
OPERATING TEMPERATURE AND SUPPLY VOLTAGE RANGE^(1,8) (V_{CC} = 5.0V ± 10%)

Symbol	Parameter	Test Conditions	Version	7132 x 20 ^(2,6) 7142 x 20 ^(2,6)		7132 x 25 ⁽⁶⁾ 7142 x 25 ⁽⁶⁾		7132 x 30 ⁽⁶⁾ 7142 x 30 ⁽⁶⁾		7132 x 35 ⁽⁷⁾ 7142 x 35 ⁽⁷⁾		7132 x 45 7142 x 45		Unit
				Typ.	Max.	Typ.	Max.	Typ.	Max.	Typ.	Max.	Typ.	Max.	
I _{CC}	Dynamic Operating Current (Both Ports Active)	$\overline{CE} = V_{IL}$ Outputs Open f = f _{MAX} ⁽⁴⁾	Mil. SA	—	—	125	300	125	295	125	290	75	230	mA
				LA	—	—	125	240	125	235	125	230	75	
I _{S81}	Standby Current (Both Ports - TTL Level Inputs)	\overline{CE}_L and $\overline{CE}_R \geq V_{IH}$ f = f _{MAX} ⁽⁴⁾	Mil. SA	—	—	30	80	30	80	30	80	25	65	mA
				LA	—	—	30	60	30	60	30	60	25	
I _{S82}	Standby Current (One Port - TTL Level Inputs)	\overline{CE}_L or $\overline{CE}_R \geq V_{IH}$ Active Port Outputs Open, f = f _{MAX} ⁽⁴⁾	Mil. SA	—	—	80	195	80	190	80	185	40	135	mA
				LA	—	—	80	160	80	155	80	150	40	
I _{S83}	Full Standby Current (Both Ports - All CMOS Level Inputs)	Both Ports \overline{CE}_L and $\overline{CE}_R \geq V_{CC} - 0.2V$ V _{IN} ≥ V _{CC} - 0.2V or V _{IN} ≤ 0.2V, f = 0 ⁽⁵⁾	Mil. SA	—	—	1.0	30	1.0	30	1.0	30	1.0	30	mA
				LA	—	—	0.2	10	0.2	10	0.2	10	0.2	
I _{S84}	Full Standby Current (One Port - All CMOS Level Inputs)	One Port \overline{CE}_L or $\overline{CE}_R \geq V_{CC} - 0.2V$ V _{IN} ≥ V _{CC} - 0.2V or V _{IN} ≤ 0.2V Active Port Outputs Open, f = f _{MAX} ⁽⁴⁾	Mil. SA	—	—	70	185	70	180	70	175	40	125	mA
				LA	—	—	70	150	70	145	70	140	35	
			Com'l. SA	1.0	15	1.0	15	1.0	15	1.0	15	1.0	15	
				LA	0.2	5	0.2	5	0.2	5	0.2	4	0.2	
			Com'l. SA	70	175	70	170	70	165	40	115	40	105	
				LA	70	140	70	135	70	130	35	90	35	



2692 tbl 05

NOTES:

- x In part numbers indicates power rating (SA or LA).
- 0°C to +70°C temperature range only.
- 55°C to +125°C temperature range only.
- At f = f_{MAX}, address and control lines (except Output Enable) are cycling at the maximum frequency read cycle of 1/T_{RC}, and using "AC TEST CONDITIONS" of Input levels of GND to 3V.
- f = 0 means no address or control lines change. Applies only to Inputs at CMOS level standby.
- Not available in DIP packages — see 7032/7042 data sheet.
- DIP packages for 0°C to +70°C temperature range only — see 7032/7042 data sheet.
- V_{CC} = 5V, T_A = +25°C for Typ.
- At V_{CC} ≤ 2.0V Input leakages are undefined.

DC ELECTRICAL CHARACTERISTICS OVER THE OPERATING TEMPERATURE AND SUPPLY VOLTAGE RANGE (1,8) (Continued) (V_{CC} = 5.0V ± 10%)

T-46-23-12

Symbol	Parameter	Test Conditions	Version	7132 x 55	7132 x 70	7132 x 90	7132 x 100	7132 x 120 ⁽³⁾	Unit
				7142 x 55 Typ. Max.	7142 x 70 Typ. Max.	7142 x 90 Typ. Max.	7142 x 100 Typ. Max.	7142 x 120 Typ. Max.	
I _{CC}	Dynamic Operating Current (Both Ports Active)	CE = V _{IL} Outputs Open f = f _{MAX} ⁽⁴⁾	Mil. SA	65 230	65 225	65 200	65 190	65 190	mA
			LA	65 185	65 180	65 160	65 155	65 155	
I _{SB1}	Standby Current (Both Ports - TTL Level Inputs)	CE _L and CE _R ≥ V _{IH} f = f _{MAX} ⁽⁴⁾	Mil. SA	65 180	65 180	65 180	65 180	65 180	mA
			LA	65 140	65 135	65 130	65 130	— —	
I _{SB2}	Standby Current (One Port - TTL Level Inputs)	CE _L or CE _R ≥ V _{IH} Active Port Outputs Open, f = f _{MAX} ⁽⁴⁾	Mil. SA	40 135	40 135	40 125	40 125	40 125	mA
			LA	40 110	40 110	40 100	40 100	40 100	
I _{SB3}	Full Standby Current (Both Ports - All CMOS Level Inputs)	Both Ports CE _L and CE _R ≥ V _{CC} - 0.2V V _{IN} ≥ V _{CC} - 0.2V or V _{IN} ≤ 0.2V, f = 0 ⁽⁵⁾	Mil. SA	1.0 30	1.0 30	1.0 30	1.0 30	1.0 30	mA
			LA	0.2 10	0.2 10	0.2 10	0.2 10	0.2 10	
I _{SB4}	Full Standby Current (One Port - All CMOS Level Inputs)	One Port CE _L or CE _R ≥ V _{CC} - 0.2V V _{IN} ≥ V _{CC} - 0.2V or V _{IN} ≤ 0.2V Active Port Outputs Open, f = f _{MAX} ⁽⁴⁾	Mil. SA	40 120	40 115	40 110	40 110	40 110	mA
			LA	35 90	35 85	35 80	35 80	35 80	
			Com'l. SA	40 115	40 110	40 110	40 110	40 110	
			LA	40 85	40 85	40 75	40 75	40 75	
			Com'l. SA	1.0 15	1.0 15	1.0 15	1.0 15	1.0 15	
			LA	0.2 4	0.2 4	0.2 4	0.2 4	0.2 4	
			Com'l. SA	40 100	40 100	40 95	40 95	40 95	
			LA	35 75	35 75	35 70	35 70	35 70	

2692 tbl 06

NOTES:

- x In part numbers indicates power rating (SA or LA).
- 0°C to +70°C temperature range only.
- 55°C to +125°C temperature range only.
- At f = f_{MAX}, address and control lines (except Output Enable) are cycling at the maximum frequency read cycle of 1/t_{RC}, and using "AC TEST CONDITIONS" of input levels of GND to 3V.
- f = 0 means no address or control lines change. Applies only to inputs at CMOS level standby.
- Not available in DIP packages — see 7032/7042 data sheet.
- DIP packages for 0°C to +70°C temperature range only — see 7032/7042 data sheet.
- V_{CC}=5V, T_A=+25°C for Typ.

DATA RETENTION CHARACTERISTICS (LA Version Only)

Symbol	Parameter	Test Conditions	IDT7132LA/IDT7142LA			Unit	
			Min.	Typ.	Max.		
V _{DR}	V _{CC} for Data Retention	V _{CC} = 2.0V, CE ≥ V _{CC} - 0.2V V _{IN} ≥ V _{CC} - 0.2V or V _{IN} ≤ 0.2V	2.0	—	0	V	
I _{CCDR}	Data Retention Current		Mil.	—	100	4000	μA
			Com'l.	—	100	1500	μA
t _{CDR} ⁽³⁾	Chip Deselect to Data Retention Time	0	—	—	ns		
t _R ⁽³⁾	Operation Recovery Time	t _{RC} ⁽²⁾	—	—	ns		

2692 tbl 07

NOTES:

- V_{CC} = 2V, T_A = +25°C
- t_{RC} = Read Cycle Time
- This parameter is guaranteed but not tested.

DATA RETENTION WAVEFORM

AC TEST CONDITIONS

T-46-23-12

Input Pulse Levels	GND TO 3.0V
Input Rise/Fall Times	5ns
Input Timing Reference Levels	1.5V
Output Reference Levels	1.5V
Output Load	See Figures 1, 2, & 3

2692 tbl 08

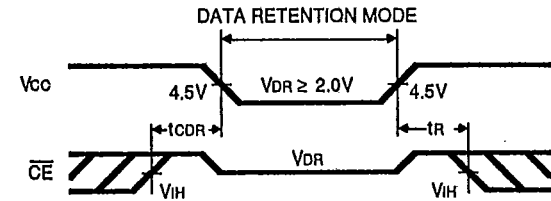

2692 drw 05

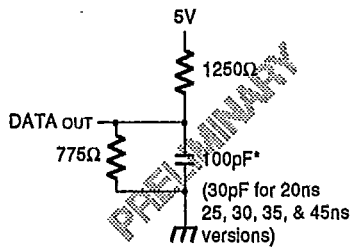

Figure 1. Output Load

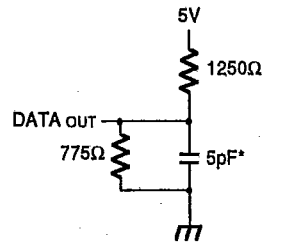

Figure 2. Output Load
(for tHV, tLZ, tWZ, and tOW)

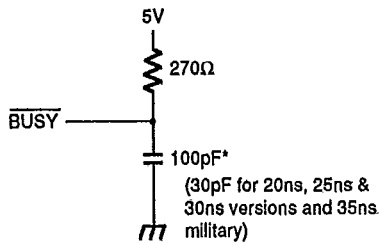

Figure 3. Busy Output Load
(IDT7132 only)

* Including scope and jig

2692 drw 06



AC ELECTRICAL CHARACTERISTICS OVER THE OPERATING TEMPERATURE AND SUPPLY VOLTAGE RANGE⁽⁵⁾

T-46-23-12

Symbol	Parameter	7132 x 20 ^(2,6) 7142 x 20 ^(2,6)		7132 x 25 ⁽⁶⁾ 7142 x 25 ⁽⁶⁾		7132 x 30 ⁽⁶⁾ 7142 x 30 ⁽⁶⁾		7132 x 35 ⁽⁷⁾ 7142 x 35 ⁽⁷⁾		7132 x 45 7142 x 45		Unit
		Min.	Max.	Min.	Max.	Min.	Max.	Min.	Max.	Min.	Max.	
Read Cycle												
t _{RC}	Read Cycle Time	20	25	25	30	30	35	35	45	45	—	ns
t _{AA}	Address Access Time	—	20	—	25	—	30	—	35	—	45	ns
t _{ACE}	Chip Enable Access Time	—	20	—	25	—	30	—	35	—	45	ns
t _{AOE}	Output Enable Access Time	—	10	—	12	—	15	—	25	—	30	ns
t _{OH}	Output Hold From Address Change	0	—	0	—	0	—	0	—	0	—	ns
t _{LZ}	Output Low Z Time ^(1,4)	0	—	0	—	0	—	5	—	5	—	ns
t _{HZ}	Output High Z Time ^(1,4)	—	8	—	10	—	12	—	15	—	20	ns
t _{PU}	Chip Enable to Power Up Time ⁽⁴⁾	0	—	0	—	0	—	0	—	0	—	ns
t _{PD}	Chip Disable to Power Down Time ⁽⁴⁾	—	50	—	50	—	50	—	50	—	50	ns

2692 tbl 09

AC ELECTRICAL CHARACTERISTICS OVER THE OPERATING TEMPERATURE AND SUPPLY VOLTAGE RANGE⁽⁵⁾ (Continued)

Symbol	Parameter	7132 x 55 7142 x 55		7132 x 70 7142 x 70		7132 x 90 7142 x 90		7132 x 100 7142 x 100		7132 x 120 ⁽³⁾ 7142 x 120 ⁽³⁾		Unit
		Min.	Max.	Min.	Max.	Min.	Max.	Min.	Max.	Min.	Max.	
Read Cycle												
t _{RC}	Read Cycle Time	55	—	70	—	90	—	100	—	120	—	ns
t _{AA}	Address Access Time	—	55	—	70	—	90	—	100	—	120	ns
t _{ACE}	Chip Enable Access Time	—	55	—	70	—	90	—	100	—	120	ns
t _{AOE}	Output Enable Access Time	—	35	—	40	—	40	—	40	—	60	ns
t _{OH}	Output Hold From Address Change	0	—	0	—	10	—	10	—	10	—	ns
t _{LZ}	Output Low Z Time ^(1,4)	5	—	5	—	5	—	5	—	5	—	ns
t _{HZ}	Output High Z Time ^(1,4)	—	30	—	35	—	40	—	40	—	40	ns
t _{PU}	Chip Enable to Power Up Time ⁽⁴⁾	0	—	0	—	0	—	0	—	0	—	ns
t _{PD}	Chip Disable to Power Down Time ⁽⁴⁾	—	50	—	50	—	50	—	50	—	50	ns

2692 tbl 10

NOTES:

1. Transition is measured ±500mV from low or high impedance voltage with load (Figures 1, 2 and 3).
2. 0°C to +70°C temperature range only.
3. -55°C to +125°C temperature range only.
4. This parameter guaranteed but not tested.
5. "x" in part numbers indicates power rating (SA or LA).
6. Not available in DIP packages — see 7032/7042 data sheet.
7. DIP packages for 0°C to +70°C temperature range only — see 7032/7042 data sheet.

TIMING WAVEFORM OF READ CYCLE NO. 1, EITHER SIDE^(1,2,4)

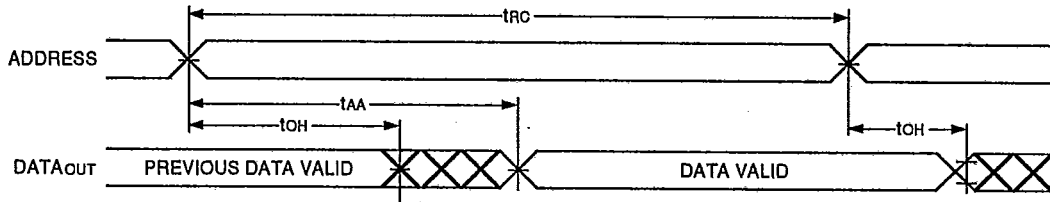

NOTES:

1. R/W is high for Read Cycles.
2. Device is continuously enabled, $\overline{CE} = V_{IL}$.
3. Addresses valid prior to or coincident with \overline{CE} transition low.
4. $\overline{CE} = V_{IL}$.

2692 drw 07

TIMING WAVEFORM OF READ CYCLE NO. 2, EITHER SIDE (1,3)

T-46-23-12

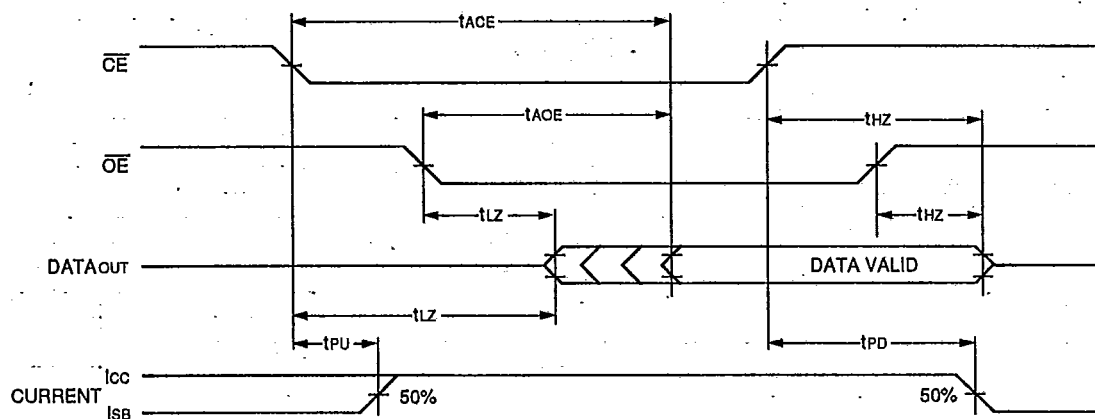

2692 drw 08

- NOTES:
1. R/W is high for Read Cycles.
 2. Device is continuously enabled, $\overline{CE} = V_{IL}$.
 3. Addresses valid prior to or coincident with \overline{CE} transition low.
 4. $\overline{OE} = V_{IL}$.

AC ELECTRICAL CHARACTERISTICS OVER THE OPERATING TEMPERATURE AND SUPPLY VOLTAGE RANGE⁽⁷⁾

Symbol	Parameter	7132 x 20 ^(2,8)		7132 x 25 ⁽⁸⁾		7132 x 30 ⁽⁸⁾		7132 x 35 ⁽⁹⁾		7132 x 45		Unit
		Min.	Max.	Min.	Max.	Min.	Max.	Min.	Max.	Min.	Max.	
Write Cycle												
tWC	Write Cycle Time ⁽⁶⁾	20	—	25	—	30	—	35	—	45	—	ns
tEW	Chip Enable to End of Write	15	—	20	—	25	—	30	—	35	—	ns
tAW	Address Valid to End of Write	15	—	20	—	25	—	30	—	35	—	ns
tAS	Address Set-up Time	0	—	0	—	0	—	0	—	0	—	ns
tWP	Write Pulse Width ⁽⁶⁾	15	—	20	—	25	—	30	—	35	—	ns
tWR	Write Recovery Time	0	—	0	—	0	—	0	—	0	—	ns
tDW	Data Valid to End of Write	10	—	12	—	15	—	20	—	20	—	ns
tHZ	Output High Z Time ^(1,4)	—	8	—	10	—	12	—	15	—	20	ns
tDH	Data Hold Time	0	—	0	—	0	—	0	—	0	—	ns
tWZ	Write Enabled to Output in High Z ^(1,4)	—	8	—	10	—	12	—	15	—	20	ns
tOW	Output Active From End of Write ^(1,4)	0	—	0	—	0	—	0	—	0	—	ns

2692 tbl 11

- NOTES:
1. Transition is measured $\pm 500mV$ from low or high impedance voltage with load (Figures 1, 2, and 3).
 2. 0°C to +70°C temperature range only.
 3. -55°C to +125°C temperature range only.
 4. This parameter guaranteed but not tested.
 5. For MASTER/SLAVE combination, $t_{WC} = t_{AAA} + t_{WP}$.
 6. Specified for \overline{OE} at high (Refer to "Timing Waveform of Write Cycle", Note 7)
 7. "x" in part numbers indicates power rating (SA or LA).
 8. Not available in DIP packages — see 7032/7042 data sheet.
 9. DIP packages for 0°C to +70°C temperature range only — see 7032/7042 data sheet.

AC ELECTRICAL CHARACTERISTICS OVER THE
OPERATING TEMPERATURE AND SUPPLY VOLTAGE RANGE⁽⁷⁾ (Continued)

T-46-23-12

Symbol	Parameter	7132 x 55	7132 x 70	7132 x 90	7132 x 100	7132 x 120 ⁽³⁾	Unit
		7142 x 55 Min. Max.	7142 x 70 Min. Max.	7142 x 90 Min. Max.	7142 x 100 Min. Max.	7142 x 120 ⁽³⁾ Min. Max.	
Write Cycle							
tWC	Write Cycle Time ⁽⁵⁾	55 —	70 —	90 —	100 —	120 —	ns
tEW	Chip Enable to End of Write	40 —	50 —	85 —	90 —	100 —	ns
tAW	Address Valid to End of Write	40 —	50 —	85 —	90 —	100 —	ns
tAS	Address Set-up Time	0 —	0 —	0 —	0 —	0 —	ns
tWP	Write Pulse Width ⁽⁶⁾	40 —	50 —	55 —	55 —	65 —	ns
tWR	Write Recovery Time	0 —	0 —	0 —	0 —	0 —	ns
tDW	Data Valid to End of Write	20 —	30 —	40 —	40 —	40 —	ns
tHZ	Output High Z Time ^(1,4)	— 30	— 35	— 40	— 40	— 40	ns
tDH	Data Hold Time	0 —	0 —	0 —	0 —	0 —	ns
tWZ	Write Enabled to Output in High Z ^(1,4)	— 30	— 35	— 40	— 40	— 50	ns
tOW	Output Active From End of Write ^(1,4)	0 —	0 —	0 —	0 —	0 —	ns

NOTES:

1. Transition is measured $\pm 500\text{mV}$ from low or high impedance voltage with load (Figures 1, 2 and 3).
2. 0°C to $+70^\circ\text{C}$ temperature range only.
3. -55°C to $+125^\circ\text{C}$ temperature range only.
4. This parameter guaranteed but not tested.
5. For MASTER/SLAVE combination, $t_{WC} = t_{AAA} + t_{WP}$.
6. Specified for OE at high (Refer to "Timing Waveform of Write Cycle", Note 7)
7. "x" in part numbers indicates power rating (SA or LA).

2692 tbl 12

CAPACITANCE ($T_A = +25^\circ\text{C}, f = 1.0\text{MHz}$)

Symbol	Parameter ⁽¹⁾	Conditions	Max.	Unit
CIN	Input Capacitance	$V_{IN} = 0\text{V}$	11	pF
COUT	Output Capacitance	$V_{IN} = 0\text{V}$	11	pF

NOTE:

1. This parameter is sampled and not 100% tested.

2692 tbl 13

TIMING WAVEFORM OF WRITE CYCLE NO. 1, ($\overline{R/\overline{W}}$ CONTROLLED TIMING)^(1,2,3,7)

T-46-23-12

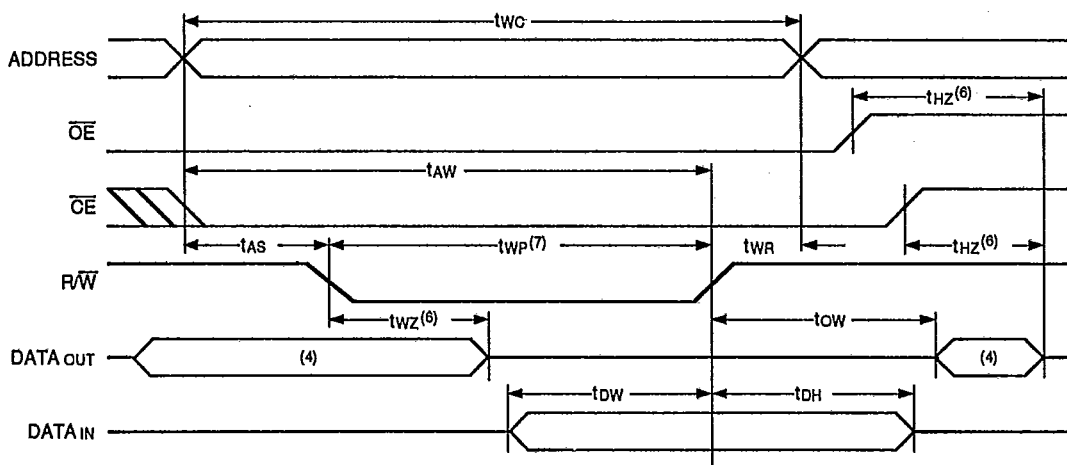

2692 drw 09

TIMING WAVEFORM OF WRITE CYCLE NO. 2, (\overline{CE} CONTROLLED TIMING)^(1,2,3,5)

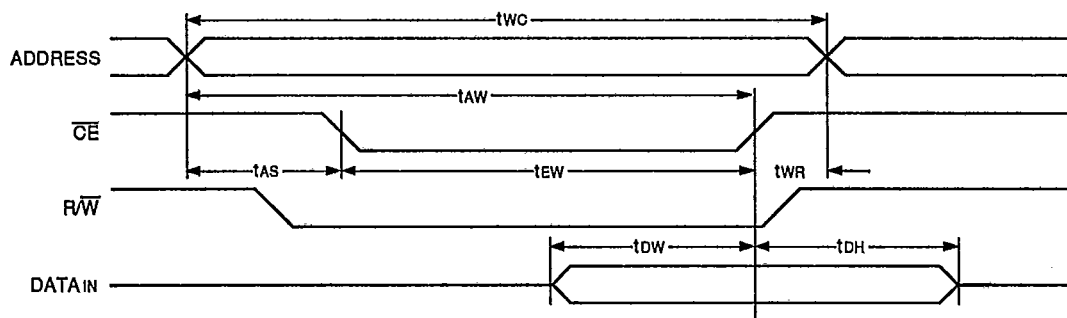

2692 drw 10

NOTES:

1. $\overline{R/\overline{W}}$ must be high during all address transitions.
2. A write occurs during the overlap (t_{EW} or t_{WP}) of a low \overline{CE} and a low $\overline{R/\overline{W}}$.
3. t_{WR} is measured from the earlier of \overline{CE} or $\overline{R/\overline{W}}$ going high to the end of the write cycle.
4. During this period, the I/O pins are in the output state and input signals must not be applied.
5. If the \overline{CE} low transition occurs simultaneously with or after the $\overline{R/\overline{W}}$ low transition, the outputs remain in the high impedance state.
6. Transition is measured $\pm 500mV$ from steady state with a 5pF load (including scope and jig).
7. If \overline{CE} is low during a $\overline{R/\overline{W}}$ controlled write cycle, the write pulse width must be larger of t_{WP} or $(t_{WZ} + t_{WP})$ to allow the I/O drivers to turn off and data to be placed on the bus for the required t_{OW} . If \overline{CE} is high during an $\overline{R/\overline{W}}$ controlled write cycle, this requirement does not apply and the write pulse can be as short as the specified t_{WP} .



AC ELECTRICAL CHARACTERISTICS OVER THE OPERATING TEMPERATURE AND SUPPLY VOLTAGE RANGE⁽⁸⁾

T-46-23-12

Symbol	Parameter	7132 x 20 ^(1,10)		7132 x 25 ⁽¹⁰⁾		7132 x 30 ⁽¹⁰⁾		7132 x 35 ⁽¹¹⁾		7132 x 45		Unit
		Min.	Max.	Min.	Max.	Min.	Max.	Min.	Max.	Min.	Max.	
Busy Timing (For Master IDT7132 Only)												
tBAA	BUSY Access Time to Address	—	20	—	25	—	30	—	35	—	35	ns
tBDA	BUSY Disable Time to Address	—	20	—	20	—	25	—	30	—	35	ns
tBAC	BUSY Access Time to Chip Enable	—	20	—	20	—	25	—	30	—	30	ns
tBDC	BUSY Disable Time to Chip Enable	—	20	—	20	—	25	—	25	—	25	ns
tWDD	Write Pulse to Data Delay ⁽³⁾	—	50	—	50	—	50	—	60	—	70	ns
tDDD	Write Data Valid to Read Data Delay ⁽³⁾	—	35	—	35	—	35	—	35	—	45	ns
tAPS	Arbitration Priority Set-up Time ⁽⁴⁾	5	—	5	—	5	—	5	—	5	—	ns
tBDD	BUSY Disable to Valid Data ⁽⁵⁾	—	Note 5	—	Note 5	—	Note 5	—	Note 5	—	Note 5	ns
Busy Input Timing (For Slave IDT7142 Only)												
tWB	Write to BUSY Input ⁽⁶⁾	0	—	0	—	0	—	0	—	0	—	ns
tWH	Write Hold After BUSY ⁽⁷⁾	15	—	15	—	20	—	20	—	20	—	ns
tWDD	Write Pulse to Data Delay ⁽⁹⁾	—	50	—	50	—	50	—	60	—	70	ns
tDDD	Write Data Valid to Read Data Delay ⁽⁹⁾	—	35	—	35	—	35	—	35	—	45	ns

2692 tbl 14

AC ELECTRICAL CHARACTERISTICS OVER THE OPERATING TEMPERATURE AND SUPPLY VOLTAGE RANGE⁽⁸⁾

Symbol	Parameter	7132 x 55		7132 x 70		7132 x 90		7132 x 100		7132 x 120 ⁽²⁾		Unit
		Min.	Max.	Min.	Max.	Min.	Max.	Min.	Max.	Min.	Max.	
Busy Timing (For Master IDT7132 Only)												
tBAA	BUSY Access Time to Address	—	45	—	45	—	45	—	50	—	60	ns
tBDA	BUSY Disable Time to Address	—	40	—	40	—	45	—	50	—	60	ns
tBAC	BUSY Access Time to Chip Enable	—	35	—	35	—	45	—	50	—	60	ns
tBDC	BUSY Disable Time to Chip Enable	—	30	—	30	—	45	—	50	—	60	ns
tWDD	Write Pulse to Data Delay ⁽³⁾	—	80	—	90	—	100	—	120	—	140	ns
tDDD	Write Data Valid to Read Data Delay ⁽³⁾	—	55	—	70	—	90	—	100	—	120	ns
tAPS	Arbitration Priority Set-up Time ⁽⁴⁾	5	—	5	—	5	—	5	—	5	—	ns
tBDD	BUSY Disable to Valid Data ⁽⁵⁾	—	Note 5	—	Note 5	—	Note 5	—	Note 5	—	Note 5	ns
Busy Input Timing (For Slave IDT7142 Only)												
tWB	Write to BUSY Input ⁽⁶⁾	0	—	0	—	0	—	0	—	0	—	ns
tWH	Write Hold After BUSY ⁽⁷⁾	20	—	20	—	20	—	20	—	20	—	ns
tWDD	Write Pulse to Data Delay ⁽⁹⁾	—	80	—	90	—	100	—	120	—	140	ns
tDDD	Write Data Valid to Read Data Delay ⁽⁹⁾	—	55	—	70	—	90	—	100	—	120	ns

2692 tbl 15

NOTES:

- 0°C to +70°C temperature range only.
- 55°C to +125°C temperature range only.
- Port-to-port delay through RAM cells from writing port to reading port, refer to "Timing Waveform of Read With BUSY (For Master IDT7132 only)".
- To ensure that the earlier of the two ports wins.
- tBDD is a calculated parameter and is the greater of 0, tWDD-tWP (actual) or tDDD - tWP (actual)
- To ensure that the write cycle is inhibited during contention.
- To ensure that a write cycle is completed after contention.
- "X" in part numbers indicates power rating (SA or LA).
- Port-to-port delay through RAM cells from writing port to reading port, refer to "Timing Waveform of Read With Port-to-Port Delay (For Slave IDT7142 Only)".
- Not available in DIP packages — see 7032/7042 data sheet.
- DIP packages for 0°C to +70°C temperature range only — see 7032/7042 data sheet.

TIMING WAVEFORM OF READ WITH $\overline{\text{BUSY}}$ (1,2,3) (FOR MASTER IDT7132 ONLY)

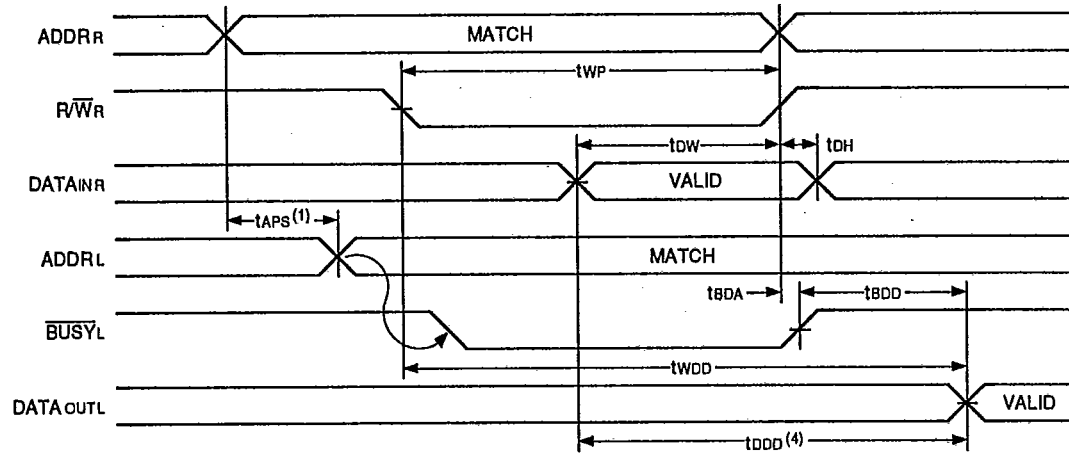

NOTES:

1. To ensure that the earlier of the two ports wins.
2. Write Cycle parameters should be adhered to in order to ensure proper writing.
3. Device is continuously enabled for both ports.
4. $\overline{\text{OE}}$ at LO for the reading port.

2692 drw 11

TIMING WAVEFORM OF READ WITH PORT-TO-PORT DELAY (1,2,3) (FOR SLAVE IDT7142 ONLY)

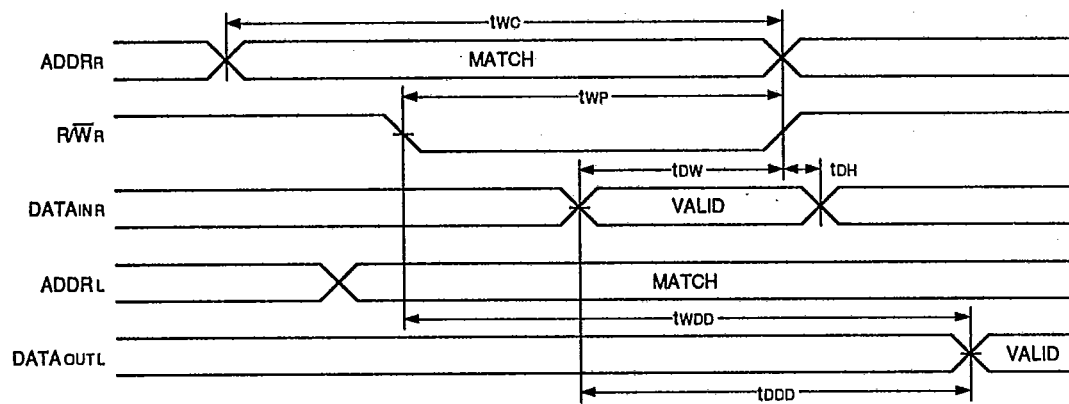

NOTES:

1. Assume $\overline{\text{BUSY}}$ input at HI for the writing port, and $\overline{\text{OE}}$ at LO for the reading port.
2. Write Cycle parameters should be adhered to in order to ensure proper writing.
3. Device is continuously enabled for both ports.

2692 drw 12

TIMING WAVEFORM OF WRITE WITH BUSY INPUT (FOR SLAVE IDT7142 ONLY)

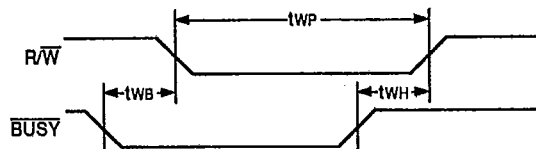

2692 drw 13

TIMING WAVEFORM OF CONTENTION CYCLE NO. 1, \overline{CE} ARBITRATION
(FOR MASTER IDT7132 ONLY)

T-46-23-12

\overline{CE}_L VALID FIRST:

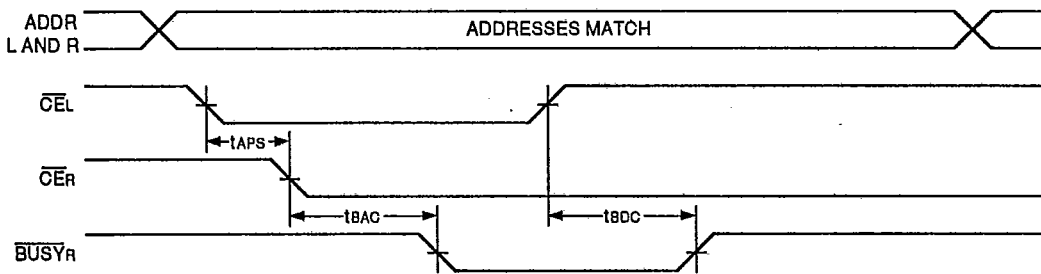

2692 drw 14

\overline{CE}_R VALID FIRST:

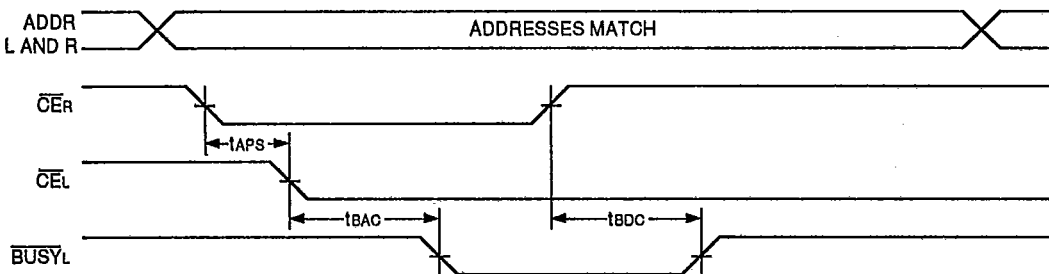

2692 drw 15

TIMING WAVEFORM OF CONTENTION CYCLE NO. 2, ADDRESS VALID ARBITRATION⁽¹⁾
(FOR MASTER IDT7132 ONLY)

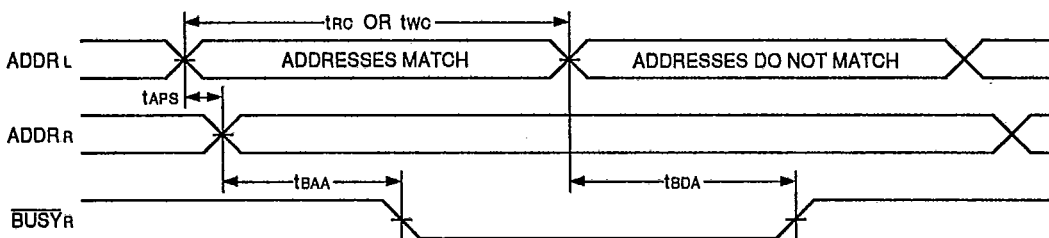

2692 drw 16

RIGHT ADDRESS VALID FIRST:

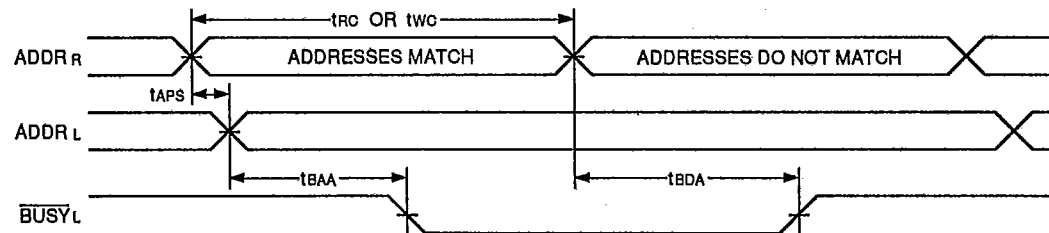

NOTE:
1. $\overline{CE}_L = \overline{CE}_R = V_L$

2692 drw 17

16-BIT MASTER/SLAVE DUAL-PORT MEMORY SYSTEMS

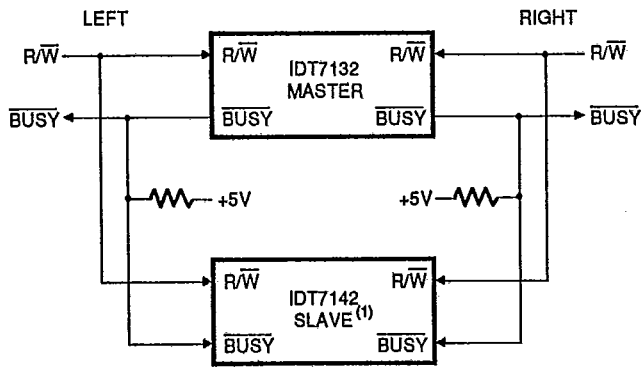

2692 drw 18

NOTE:
1. No arbitration in IDT7142 (SLAVE). $\overline{\text{BUSY-IN}}$ inhibits write in IDT7142 (SLAVE).

FUNCTIONAL DESCRIPTION:

The IDT7132/42 provides two ports with separate control, address, and I/O pins that permit independent access for reads or writes to any locations in memory. These devices have an automatic power-down feature controlled by $\overline{\text{CE}}$. The $\overline{\text{CE}}$ controls on-chip power-down circuitry that permits the respective port to go into a standby mode when not selected ($\overline{\text{CE}}$ high). When a port is enabled, access to the entire memory array is permitted. Each port has its own Output Enable control ($\overline{\text{OE}}$). In the read mode, the port's $\overline{\text{OE}}$ turns on the output drivers when set LOW. Non-contention READ/ WRITE conditions are illustrated in Table 1.

ARBITRATION LOGIC, FUNCTIONAL DESCRIPTION:

The arbitration logic will resolve an address match or a chip enable match down to 5ns minimum and determine which port has access. In all cases, an active $\overline{\text{BUSY}}$ flag will be set for the delayed port.

The $\overline{\text{BUSY}}$ flags are provided for the situation when both ports simultaneously access the same memory location. When this situation occurs, on-chip arbitration logic will determine which port has access and sets the delayed port's $\overline{\text{BUSY}}$ flag. $\overline{\text{BUSY}}$ is set at speeds that permit the processor to hold the operation and its respective address data. It is important to note that the write operation is invalid for the port that has $\overline{\text{BUSY}}$ set LOW. The delayed port will have access when $\overline{\text{BUSY}}$ goes inactive.

Contention occurs when both left and right ports are active and both addresses match. When this situation occurs, the on-chip arbitration logic determines access. Two modes of arbitration are provided: (1) if the addresses match and are valid before $\overline{\text{CE}}$, on-chip control logic arbitrates between $\overline{\text{CEL}}$

and $\overline{\text{CER}}$ for access; or (2) if the $\overline{\text{CEs}}$ are low before an address match, on-chip control logic arbitrates between the left and right addresses for access (refer to Table II). In either mode of arbitration, the delayed port's $\overline{\text{BUSY}}$ flag is set and will reset when the port granted access completes its operation.

DATA BUS WIDTH EXPANSION, MASTER/SLAVE DESCRIPTION:

Expanding the data bus width to sixteen-or-more-bits in a dual-port RAM system implies that several chips will be active at the same time. If each chip includes a hardware arbitrator, and the addresses for each chip arrive at the same time, it is possible that one will activate its $\overline{\text{BUSYL}}$ while another activates its $\overline{\text{BUSYR}}$ signal. Both sides are now busy and the CPUs will wait indefinitely for their port to become free.

To avoid the "Busy Lock-Out" problem, IDT has developed a MASTER/SLAVE approach where only one arbitrator, in the MASTER, is used. The SLAVE has $\overline{\text{BUSY}}$ inputs which allow an interface to the MASTER with no external components and with a speed advantage over other systems.

When expanding dual-port RAMs in width, the writing of the SLAVE RAMs must be delayed, until after the $\overline{\text{BUSY}}$ input has settled. Otherwise, the SLAVE chip may begin a write cycle during a contention situation. Conversely, the write pulse must extend a hold time past $\overline{\text{BUSY}}$ to ensure that a write cycle takes place after the contention is resolved. This timing is inherent in all dual-port memory systems where more than one chip is active at the same time.

The write pulse to the SLAVE should be delayed by the maximum arbitration time of the MASTER. If, then, a contention occurs, the write to the SLAVE will be inhibited due to $\overline{\text{BUSY}}$ from the MASTER.

TRUTH TABLES

T-46-23-12

TABLE I – NON-CONTENTION
READ/WRITE CONTROL⁽⁴⁾

Left Or Right Port ⁽¹⁾				Function
R/W	CE	OE	Do-7	
X	H	X	Z	Port Disabled and in Power Down Mode ISB2 or ISB4
X	H	X	Z	CE _R = CE _L = H, Power Down Mode, ISB1 or ISB3
L	L	X	DATAIN	Data on Port Written into Memory ⁽²⁾
H	L	L	DATAOUT	Data in Memory Output on Port ⁽³⁾
H	L	H	Z	High Impedance

- NOTES:
1. A_{0L} – A_{10L} ≠ A_{0R} – A_{10R}
 2. If BUSY = L, data is not written
 3. If BUSY = L, data may not be valid, see twdd and tbood timing.
 4. H = HIGH, L = LOW, X = DON'T CARE, Z = HIGH IMPEDANCE

TABLE II – ARBITRATION^(1,2)

Left Port		Right Port		Flags		Function
CE _L	A _{0L} – A _{10L}	CE _R	A _{0R} – A _{10R}	BUSYL	BUSYR	
H	X	H	X	H	H	No Contention
L	Any	H	X	H	H	No Contention
H	X	L	Any	H	H	No Contention
L	≠ A _{0R} - A _{10R}	L	≠ A _{0L} - A _{10L}	H	H	No Contention
Address Arbitration With CE Low Before Address Match						
L	LV5R	L	LV5R	H	L	L-Port Wins
L	RV5L	L	RV5L	L	H	R-Port Wins
L	Same	L	Same	H	L	Arbitration Resolved
L	Same	L	Same	L	H	Arbitration Resolved
CE Arbitration With Address Match Before CE						
LL5R	= A _{0R} - A _{10R}	LL5R	= A _{0L} - A _{10L}	H	L	L-Port Wins
RL5L	= A _{0R} - A _{10R}	RL5L	= A _{0L} - A _{10L}	L	H	R-Port Wins
LW5R	= A _{0R} - A _{10R}	LW5R	= A _{0L} - A _{10L}	H	L	Arbitration Resolved
LW5R	= A _{0R} - A _{10R}	LW5R	= A _{0L} - A _{10L}	L	H	Arbitration Resolved

- NOTES:
1. X = DON'T CARE, L = LOW, H = HIGH
 2. LV5R = Left Address Valid ≥ 5ns before right address.
RV5L = Right Address Valid ≥ 5ns before left address.
Same = Left and Right Addresses match within 5ns of each other.
LL5R = Left CE = LOW ≥ 5ns before Right CE.
RL5L = Right CE = LOW ≥ 5ns before Left CE.
LW5R = Left and Right CE = LOW within 5ns of each other.