

54AC158 • 54ACT158 Quad 2-Input Multiplexer

General Description

The 'AC/'ACT158 is a high-speed quad 2-input multiplexer. It selects four bits of data from two sources using the common Select and Enable inputs. The four buffered outputs present the selected data in the inverted form. The 'AC/'ACT158 can also be used as a function generator.

- Outputs source/sink 24 mA
- 'ACT158 has TTL-compatible inputs
- Standard Microcircuit Drawing (SMD)
 - 'AC158: 5962-89729
 - 'ACT158: 5962-88755

Features

- I_{CC} reduced by 50%

Logic Symbols

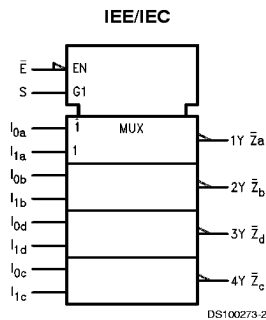
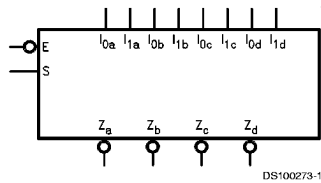

Connection Diagrams

Pin Assignment
for DIP and Flatpak

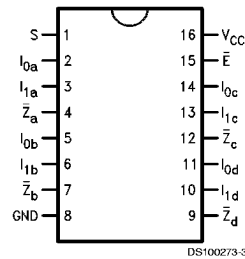

Pin Assignment
for LCC

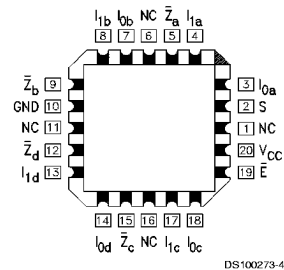

Pin Names	Description
$I_{0a}-I_{0d}$	Source 0 Data Inputs
$I_{1a}-I_{1d}$	Source 1 Data Inputs
\bar{E}	Enable Input
S	Select Input
$\bar{Z}_a-\bar{Z}_d$	Inverted Outputs

FACT™ is a trademark of Fairchild Semiconductor Corporation.

Functional Description

The 'AC/ACT158 quad 2-input multiplexer selects four bits of data from two sources under the control of a common Select input (S) and presents the data in inverted form at the four outputs. The Enable input (\bar{E}) is active-LOW. When \bar{E} is HIGH, all of the outputs (\bar{Z}) are forced HIGH regardless of all other inputs. The 'AC/ACT158 is the logic implementation of a 4-pole, 2-position switch where the position of the switch is determined by the logic levels supplied to the Select input.

A common use of the 'AC/ACT158 is the moving of data from two groups of registers to four common output busses. The particular register from which the data comes is determined by the state of the Select input. A less obvious use is as a function generator. The 'AC/ACT158 can generate four functions of two variables with one variable common. This is useful for implementing gating functions.

Truth Table

\bar{E}	Inputs			Outputs
	S	I_0	I_1	\bar{Z}
H	X	X	X	H
L	L	L	X	H
L	L	H	X	L
L	H	X	L	H
L	H	X	H	L

H = HIGH Voltage Level
L = LOW Voltage Level
X = Immaterial

Logic Diagram

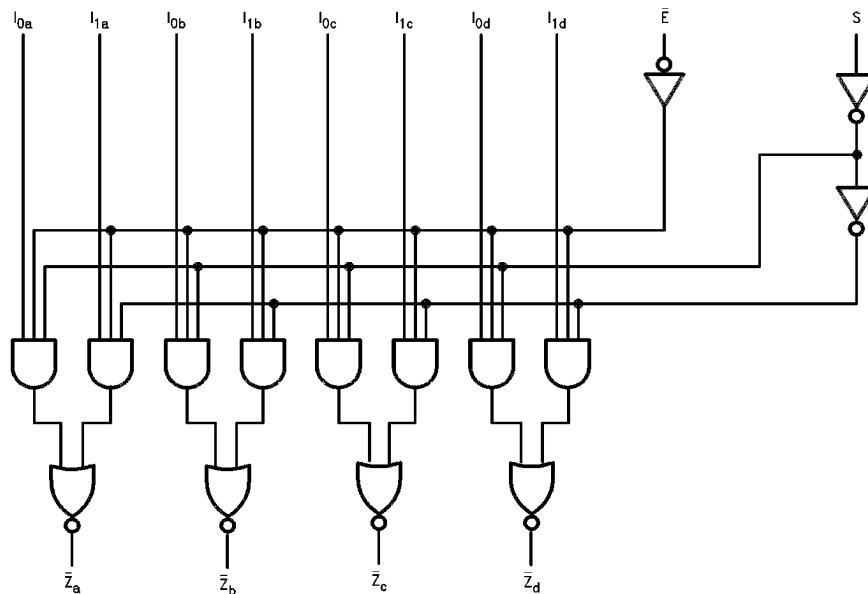

DS100273-5

Please note that this diagram is provided only for the understanding of logic operations and should not be used to estimate propagation delays.

Absolute Maximum Ratings (Note 1)

If Military/Aerospace specified devices are required, please contact the National Semiconductor Sales Office/Distributors for availability and specifications.

Supply Voltage (V_{CC})	-0.5V to +7.0V
DC Input Diode Current (I_{IK})	
$V_I = -0.5V$	-20 mA
$V_I = V_{CC} + 0.5V$	+20 mA
DC Input Voltage (V_I)	-0.5V to $V_{CC} + 0.5V$
DC Output Diode Current (I_{OK})	
$V_O = -0.5V$	-20 mA
$V_O = V_{CC} + 0.5V$	+20 mA
DC Output Voltage (V_O)	-0.5V to $V_{CC} + 0.5V$
DC Output Source	
or Sink Current (I_O)	± 50 mA
DC V_{CC} or Ground Current	
per Output Pin (I_{CC} or I_{GND})	± 50 mA
Storage Temperature (T_{STG})	-65°C to +150°C
Junction Temperature (T_J)	
CDIP	175°C

Recommended Operating Conditions

Supply Voltage (V_{CC})	
'AC	2.0V to 6.0V
'ACT	4.5V to 5.5V
Input Voltage (V_I)	0V to V_{CC}
Output Voltage (V_O)	0V to V_{CC}
Operating Temperature (T_A)	
54AC/ACT	-55°C to +125°C
Minimum Input Edge Rate ($\Delta V/\Delta t$)	
'AC Devices	
V_{IN} from 30% to 70% of V_{CC}	
V_{CC} @ 3.3V, 4.5V, 5.5V	125 mV/ns
Minimum Input Edge Rate ($\Delta V/\Delta t$)	
'ACT Devices	
V_{IN} from 0.8V to 2.0V	
V_{CC} @ 4.5V, 5.5V	125 mV/ns

Note 1: Absolute maximum ratings are those values beyond which damage to the device may occur. The databook specifications should be met, without exception, to ensure that the system design is reliable over its power supply, temperature, and output/input loading variables. National does not recommend operation of FACT™ circuits outside databook specifications.

DC Characteristics for 'AC Family Devices

Symbol	Parameter	V_{CC} (V)	54AC	Units	Conditions
			$T_A =$		
			-55°C to +125°C		
			Guaranteed Limits		
V_{IH}	Minimum High Level Input Voltage	3.0	2.1	V	$V_{OUT} = 0.1V$ or $V_{CC} - 0.1V$
		4.5	3.15		
		5.5	3.85		
V_{IL}	Maximum Low Level Input Voltage	3.0	0.9	V	$V_{OUT} = 0.1V$ or $V_{CC} - 0.1V$
		4.5	1.35		
		5.5	1.65		
V_{OH}	Minimum High Level Output Voltage	3.0	2.9	V	$I_{OUT} = -50 \mu A$
		4.5	4.4		
		5.5	5.4		
V_{OL}	Maximum Low Level Output Voltage	3.0	2.4	V	(Note 2) $V_{IN} = V_{IL}$ or V_{IH} $I_{OH} = -12$ mA $I_{OH} = -24$ mA $I_{OH} = -24$ mA
		4.5	3.7		
		5.5	4.7		
V_{OL}	Maximum Low Level Output Voltage	3.0	0.1	V	$I_{OUT} = 50 \mu A$
		4.5	0.1		
		5.5	0.1		
V_{OL}	Maximum Low Level Output Voltage	3.0	0.50	V	(Note 2) $V_{IN} = V_{IL}$ or V_{IH} $I_{OL} = 12$ mA $I_{OL} = 24$ mA $I_{OL} = 24$ mA
		4.5	0.50		
		5.5	0.50		
I_{IN}	Maximum Input Leakage Current	5.5	± 1.0	μA	$V_I = V_{CC}, GND$

DC Characteristics for 'AC Family Devices (Continued)

Symbol	Parameter	V _{CC} (V)	54AC	Units	Conditions
			T _A = -55° C to +125° C		
			Guaranteed Limits		
I _{OLD}	Minimum Dynamic Output Current (Note 3)	5.5	50	mA	V _{OLD} = 1.65V Max
I _{OHD}		5.5	-50	mA	V _{OHD} = 3.85V Min
I _{CC}	Maximum Quiescent Supply Current	5.5	80.0	μA	V _{IN} = V _{CC} or GND

Note 2: All outputs loaded; thresholds on input associated with output under test.

Note 3: Maximum test duration 2.0 ms, one output loaded at a time.

Note 4: I_{IN} and I_{CC} @ 3.0V are guaranteed to be less than or equal to the respective limit @ 5.5V V_{CC}.

I_{CC} for 54AC @ 25°C is identical to 74AC @ 25°C.

DC Characteristics for 'ACT Family Devices

Symbol	Parameter	V _{CC} (V)	54ACT	Units	Conditions
			T _A = -55° C to +125° C		
			Guaranteed Limits		
V _{IH}	Minimum High Level Input Voltage	4.5	2.0	V	V _{OUT} = 0.1V or V _{CC} - 0.1V
		5.5	2.0		
V _{IL}	Maximum Low Level Input Voltage	4.5	0.8	V	V _{OUT} = 0.1V or V _{CC} - 0.1V
		5.5	0.8		
V _{OH}	Minimum High Level Output Voltage	4.5	4.4	V	I _{OUT} = -50 μA
		5.5	5.4		
		4.5	3.70	V	(Note 5) V _{IN} = V _{IL} or V _{IH} I _{OH} = -24 mA I _{OH} = -24 mA
		5.5	4.70		
V _{OL}	Maximum Low Level Output Voltage	4.5	0.1	V	I _{OUT} = 50 μA
		5.5	0.1		
		4.5	0.50	V	(Note 5) V _{IN} = V _{IL} or V _{IH} I _{OL} = 24 mA I _{OL} = 24 mA
		5.5	0.50		
I _{IN}	Maximum Input Leakage Current	5.5	±1.0	μA	V _I = V _{CC} , GND
I _{CC(T)}	Maximum I _{CC} /Input	5.5	1.6	mA	V _I = V _{CC} - 2.1V
I _{OLD}	Minimum Dynamic Output Current (Note 6)	5.5	50	mA	V _{OLD} = 1.65V Max
I _{OHD}		5.5	-50	mA	V _{OHD} = 3.85V Min
I _{CC}	Maximum Quiescent Supply Current	5.5	80.0	μA	V _{IN} = V _{CC} or GND

Note 5: All outputs loaded; thresholds on input associated with output under test.

Note 6: Maximum test duration 2.0 ms, one output loaded at a time.

Note 7: I_{CC} for 54ACT @ 25°C is identical to 74ACT @ 25°C.

AC Electrical Characteristics

Symbol	Parameter	V _{CC} (V) (Note 8)	54AC		Units	Fig. No.
			T _A = -55°C to +125°C C _L = 50 pF			
			Min	Max		
t _{PLH}	Propagation Delay S to \bar{Z}_n	3.3	1.0	14.0	ns	
		5.0	1.0	11.0		
t _{PHL}	Propagation Delay S to \bar{Z}_n	3.3	1.0	14.0	ns	
		5.0	1.0	11.0		
t _{PLH}	Propagation Delay \bar{E} to \bar{Z}_n	3.3	1.0	15.0	ns	
		5.0	1.0	12.0		
t _{PHL}	Propagation Delay \bar{E} to \bar{Z}_n	3.3	1.0	14.0	ns	
		5.0	1.0	10.0		
t _{PLH}	Propagation Delay I _n to \bar{Z}_n	3.3	1.0	11.0	ns	
		5.0	1.0	8.5		
t _{PHL}	Propagation Delay I _n to \bar{Z}_n	3.3	1.0	10.0	ns	
		5.0	1.0	7.5		

Note 8: Voltage Range 3.3 is 3.3V ±0.3V
Voltage Range 5.0 is 5.0V ±0.5V

AC Electrical Characteristics

Symbol	Parameter	V _{CC} (V) (Note 9)	54ACT		Units	Fig. No.
			T _A = -55°C to +125°C C _L = 50 pF			
			Min	Max		
t _{PLH}	Propagation Delay S to \bar{Z}_n	5.0	1.0	12.0	ns	
			1.0	11.5		
t _{PHL}	Propagation Delay S to \bar{Z}_n	5.0	1.0	11.0	ns	
			1.0	11.0		
t _{PLH}	Propagation Delay \bar{E} to \bar{Z}_n	5.0	1.0	9.5	ns	
			1.0	8.0		
t _{PHL}	Propagation Delay \bar{E} to \bar{Z}_n	5.0	1.0	11.0	ns	
			1.0	11.0		
t _{PLH}	Propagation Delay I _n to \bar{Z}_n	5.0	1.0	9.5	ns	
			1.0	8.0		
t _{PHL}	Propagation Delay I _n to \bar{Z}_n	5.0	1.0	8.0	ns	
			1.0	8.0		

Note 9: Voltage Range 5.0 is 5.0V ±0.5V

Capacitance

Symbol	Parameter	Typ	Units	Conditions
C _{IN}	Input Capacitance	4.5	pF	V _{CC} = OPEN
C _{PD}	Power Dissipation Capacitance	45.0	pF	V _{CC} = 5.0V

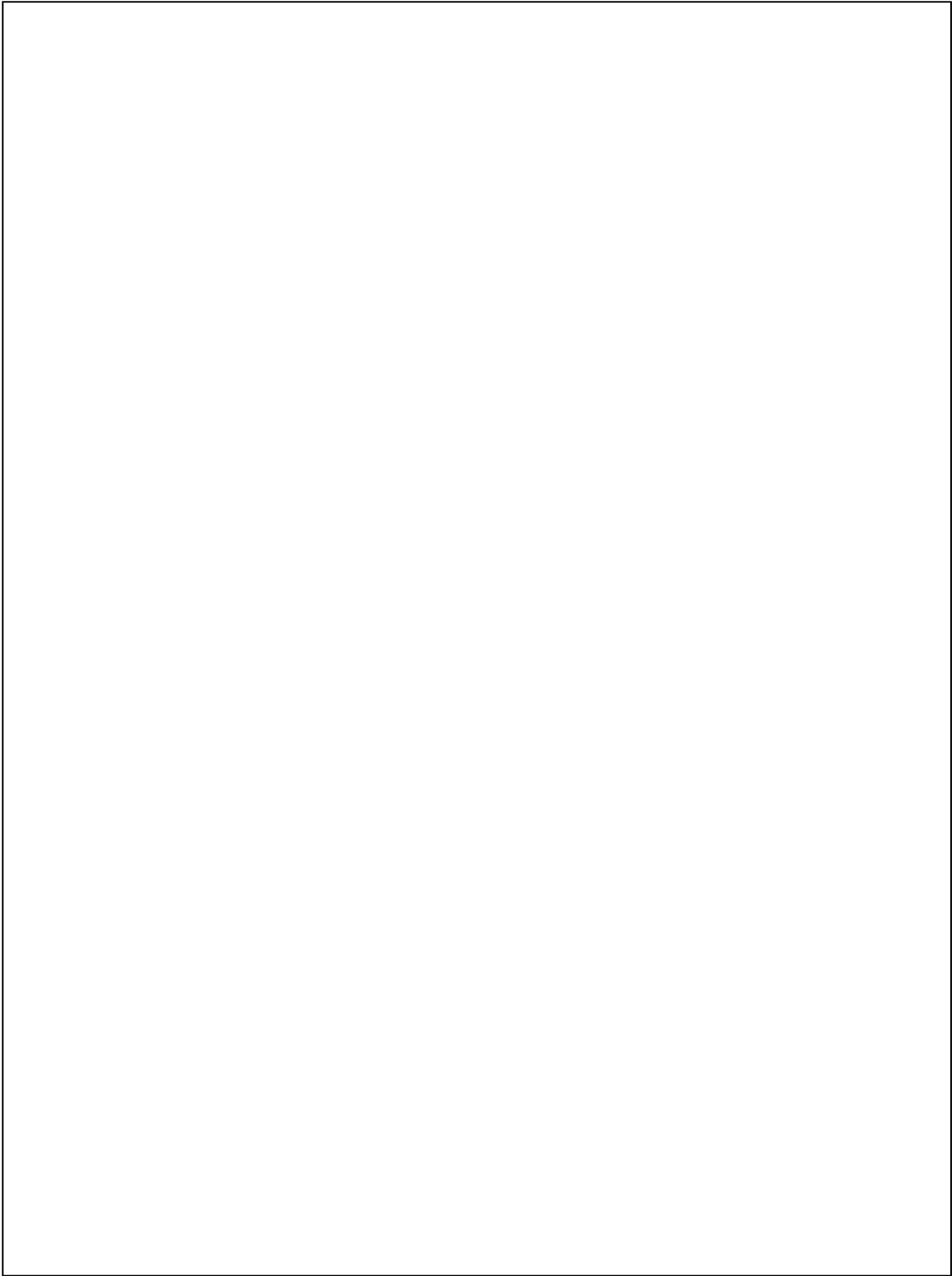

Physical Dimensions inches (millimeters) unless otherwise noted

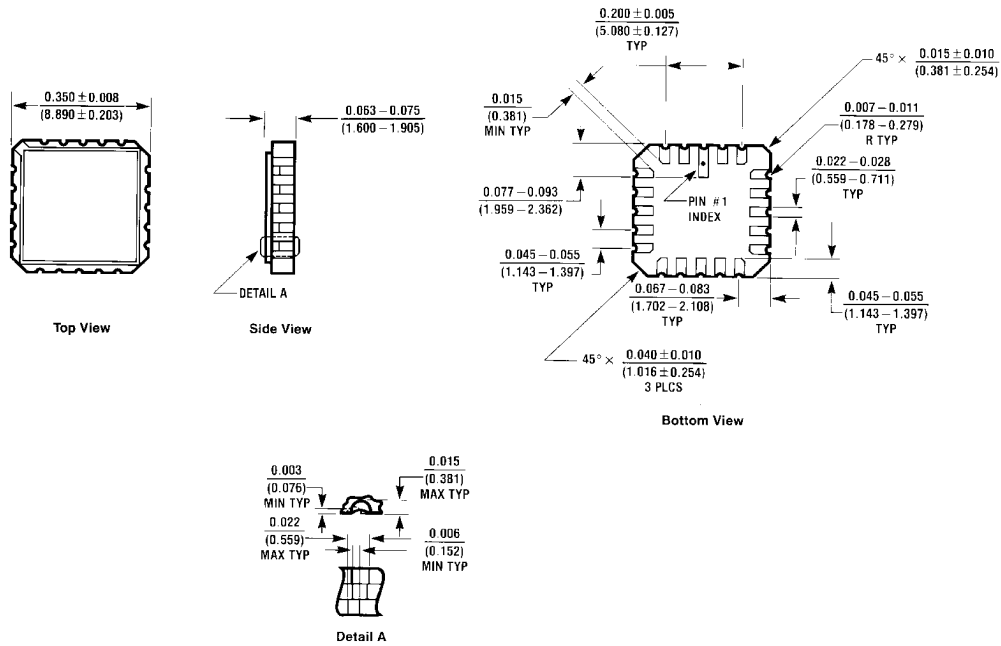

**20 Terminal Ceramic Leadless Chip Carrier (L)
 NS Package Number E20A**

E20A (REV D)

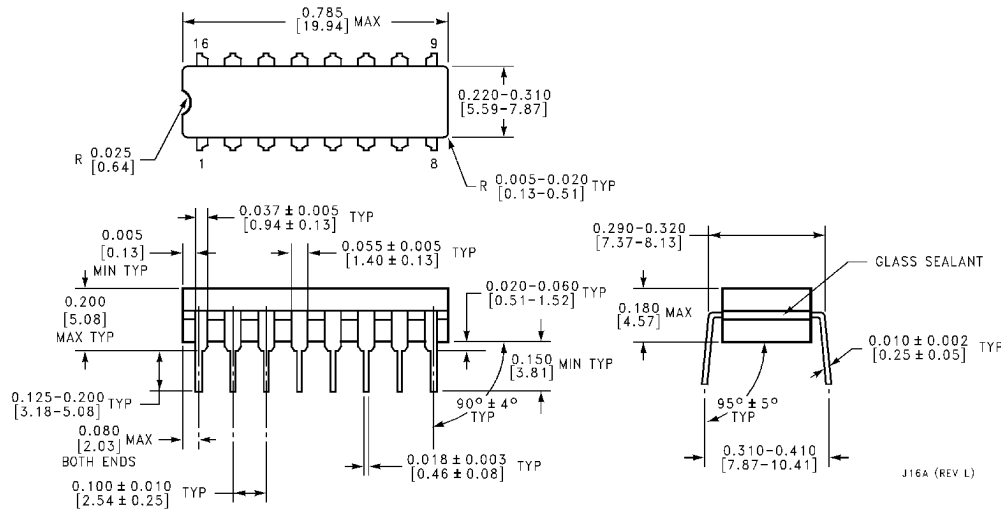

**16 Lead Ceramic Dual-In-Line Package (D)
 NS Package Number J16A**

J16A (REV L)

Physical Dimensions inches (millimeters) unless otherwise noted (Continued)

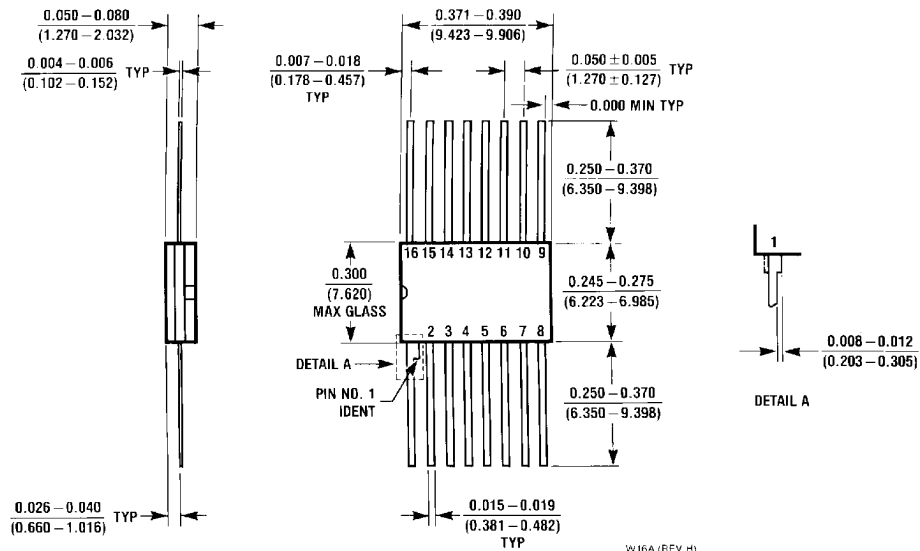

**16 Lead Ceramic Flatpak (F)
NS Package Number W16A**

LIFE SUPPORT POLICY

NATIONAL'S PRODUCTS ARE NOT AUTHORIZED FOR USE AS CRITICAL COMPONENTS IN LIFE SUPPORT DEVICES OR SYSTEMS WITHOUT THE EXPRESS WRITTEN APPROVAL OF THE PRESIDENT OF NATIONAL SEMICONDUCTOR CORPORATION. As used herein:

1. Life support devices or systems are devices or systems which, (a) are intended for surgical implant into the body, or (b) support or sustain life, and whose failure to perform when properly used in accordance with instructions for use provided in the labeling, can be reasonably expected to result in a significant injury to the user.
2. A critical component in any component of a life support device or system whose failure to perform can be reasonably expected to cause the failure of the life support device or system, or to affect its safety or effectiveness.



National Semiconductor Corporation
Americas
Tel: 1-800-272-9959
Fax: 1-800-737-7018
Email: support@nsc.com

www.national.com

National Semiconductor Europe
Fax: +49 (0) 1 80-530 85 86
Email: europe.support@nsc.com
Deutsch Tel: +49 (0) 1 80-530 85 85
English Tel: +49 (0) 1 80-532 78 32
Français Tel: +49 (0) 1 80-532 93 58
Italiano Tel: +49 (0) 1 80-534 16 80

National Semiconductor Asia Pacific Customer Response Group
Tel: 65-2544466
Fax: 65-2504466
Email: sea.support@nsc.com

National Semiconductor Japan Ltd.
Tel: 81-3-5620-6175
Fax: 81-3-5620-6179

National does not assume any responsibility for use of any circuitry described, no circuit patent licenses are implied and National reserves the right at any time without notice to change said circuitry and specifications.