

Round-type contact mount LEDs (for automatic insertion)

SEL6010 series (Standard type)

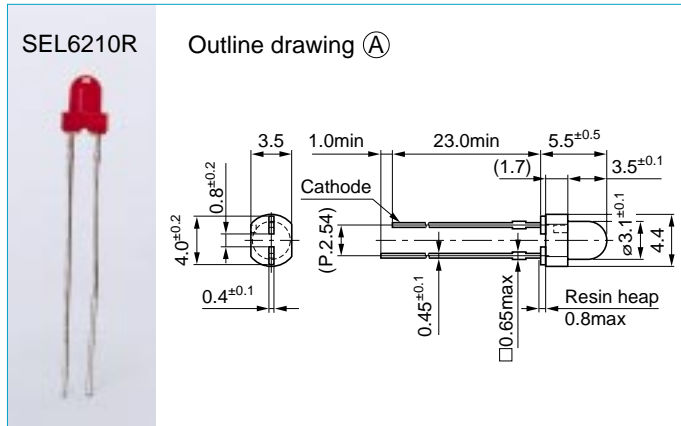

SEL6014 series (Wide viewing angle)

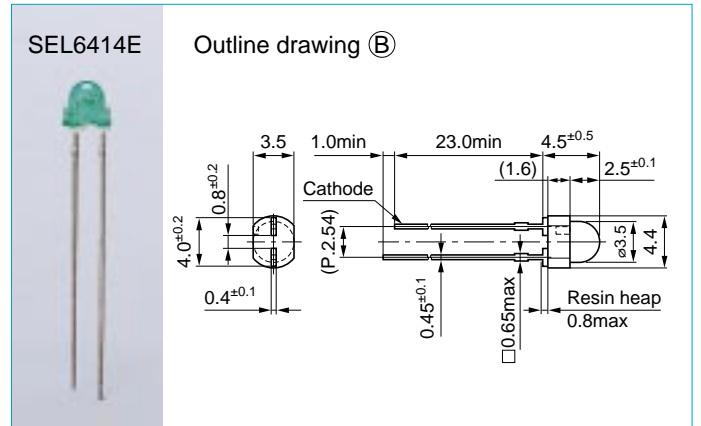

Absolute maximum ratings (Ta=25°C)

Symbol	Unit	Rated
I _F	mA	30
I _{FP}	mA	100
V _R	V	3
Top	°C	-30 to +85
Tstg	°C	-30 to +100

SEL6000 series LEDs packaged on tapes can withstand shocks caused by insertion machines; Thus, they can be contact-mounted automatically on circuit boards.

Recommended dimensions of insertion holes on printed circuit boards

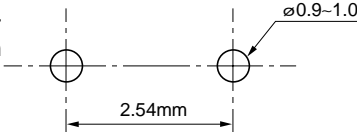

SEL6015 series (Narrow viewing angle)

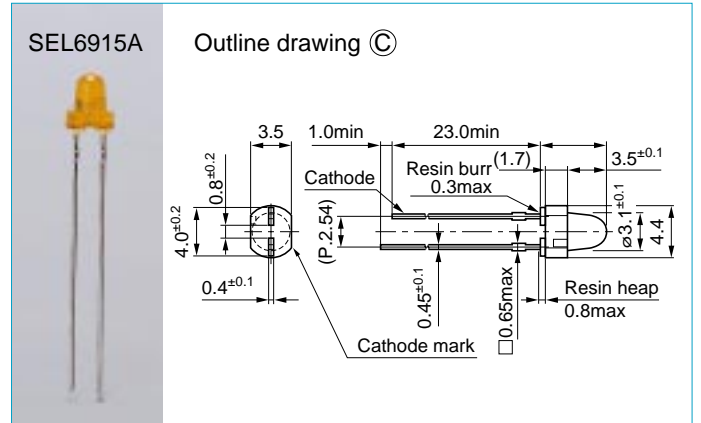

External dimensions: Unit: mm Tolerance: ±0.3

Viewing angle

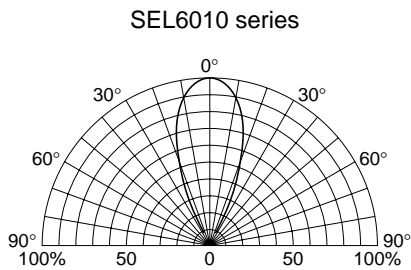

Viewing angle of a non-diffused lens

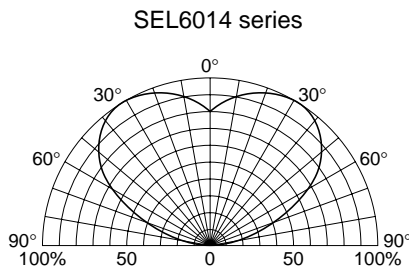

Viewing angle of a non-diffused lens

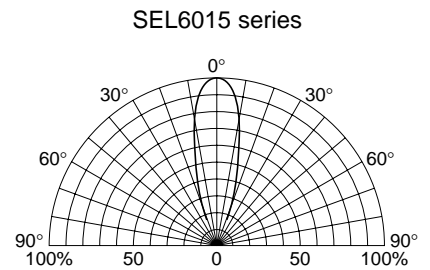

Viewing angle of a non-diffused lens

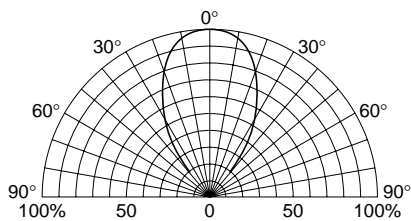

Viewing angle of a diffused lens

Type No.	Display form (ϕ : mm)	Type of lens	Emitting color	Electro-optical characteristics (Ta=25°C)								Outline drawing	
				V _F (V)		Condition I _F (mA)	I _R (μ A)	Condition V _R (V)	I _v (mcd)		λ_p (nm)		$\Delta\lambda$ (nm) typ
				typ	max				typ	Condition I _F (mA)			
SEL6210R	●3.1	Red tinted, diffused	High intensity red	1.9					12	20	630	35	Ⓐ
SEL6210S	●3.1	Red tinted, non-diffused							25				
SEL6410G	●3.1	Green tinted, diffused	Green	2.0	2.5	10	50	3	15	10	560	20	
SEL6410E	●3.1	Green tinted, non-diffused							45				
SEL6510G	●3.1	Green tinted, diffused	Pure green	2.0	2.5	10	50	3	5	10	555	20	
SEL6510C	●3.1	Un-tinted, non-diffused							16				
SEL6710Y	●3.1	Yellow tinted, diffused	Yellow	2.0	2.5	10	50	3	5	10	570	40	
SEL6710K	●3.1	Yellow tinted, non-diffused							15				
SEL6810D	●3.1	Orange tinted, diffused	Amber	1.9	2.5	10	50	3	4	10	610	35	
SEL6810A	●3.1	Orange tinted, non-diffused							10				
SEL6910D	●3.1	Orange tinted, diffused	Orange	1.9	2.5	10	50	3	6.5	10	587	33	
SEL6910A	●3.1	Orange tinted, non-diffused							14				
SEL6214S	●3.5	Red tinted, non-diffused	High intensity red	1.9	2.5	10	50	3	10	20	630	35	Ⓑ
SEL6414E	●3.5	Green tinted, non-diffused	Green	2.0					12				
SEL6514C	●3.5	Un-tinted, non-diffused	Pure green	2.0	6	10	555	20					
SEL6814A	●3.5	Orange tinted, non-diffused	Amber	1.9	5				610	35			
SEL6914A	●3.5	Orange tinted, non-diffused	Orange	1.9	5	587	33						
SEL6215S	●3.1	Red tinted, non-diffused	High intensity red	1.9	2.5	10	50	3	30	20	630	35	
SEL6415E	●3.1	Green tinted, non-diffused	Green	2.0					50				
SEL6515C	●3.1	Un-tinted, non-diffused	Pure green	2.0	18	10	555	20					
SEL6815A	●3.1	Orange tinted, non-diffused	Amber	1.9	30				610	35			
SEL6915A	●3.1	Orange tinted, non-diffused	Orange	1.9	40	587	33						

■Using contact mount LEDs packaged on tapes

1. Printed circuit board
 - One-side printed circuit board is recommended.
 - If there are several SMD parts on the same printed circuit board, insert the LEDs after the adhesive for other SMD parts hardened.
2. Insertion conditions
 - Use low insertion pusher pressure, as much as possible.
 - Cut and clinch: Panasert T pattern is recommended.
For N pattern, make the clinching angle of the LED's anode as small as possible.
3. Soldering conditions
 - Preheating must be less than 90°C (temperature on printed circuit board's bottom surface) for no more than two minutes
 - Solder dipping must be made at a temperature of 250°C for no more than 3 seconds.