

- High power index guided type MQW InGaAlP VLD with High Monitor Current
- Package flange: $\varnothing 9\text{mm}$
- Applications include:
Bar code scanners, medical systems, laser beam printer, etc.

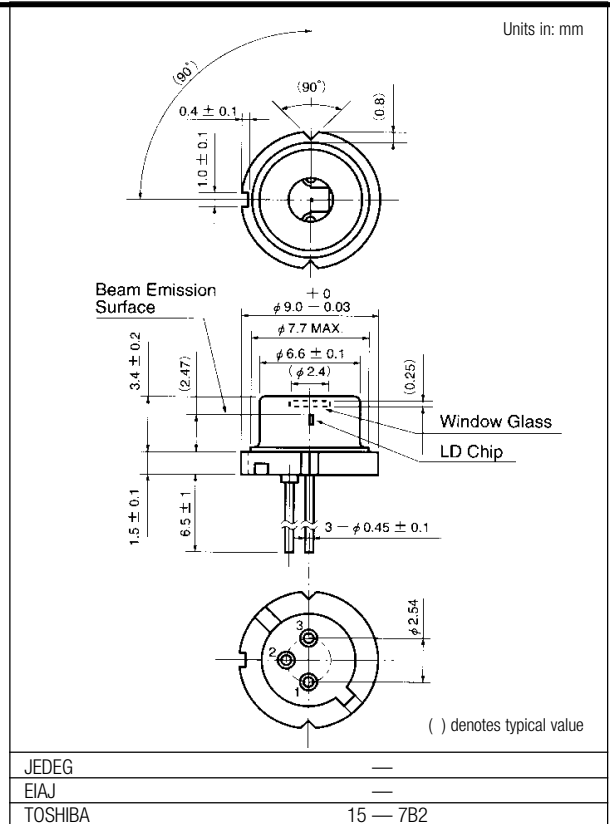
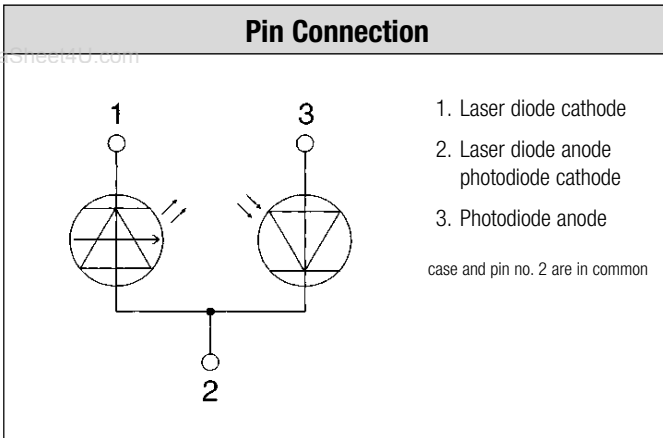

Maximum ratings ($T_c=25^\circ\text{C}$)

Characteristic	Symbol	Rating	Unit
Optical Output Power(CW)	P_O	10	mW
LD Reverse Voltage	$V_{R(LD)}$	2	V
PD Reverse Voltage	$V_{R(PD)}$	30	V
Operation Case Temperature	T_c	-10~50	$^\circ\text{C}$
Storage Temperature	T_{stg}	-40~85	$^\circ\text{C}$

Optical-electrical characteristics ($T_c=25^\circ\text{C}$)

Characteristic	Symbol	Test Condition	Min.	Typ.	Max.	Unit
Threshold Current	I_{th}	CW operation	—	45	65	mA
Operation Current	I_{op}	$P_o=10\text{mW}$	—	70	90	mA
Operation Voltage	V_{op}	$P_o=10\text{mW}$	—	2.4	3.0	V
Lasing Wavelength	λ_p	$P_o=10\text{mW}$	660	670	680	nm
Beam Divergence	$\theta_{ }$	$P_o=10\text{mW}$	5	8	11	$^\circ$
	θ_{\perp}	$P_o=10\text{mW}$	15	18	23	$^\circ$
Monitor Current	I_m	$P_o=10\text{mW}$	0.5	1.5	3.0	mA
PD Dark Current	$I_{b(PD)}$	$V_R=5\text{V}$	—	—	100	nA
PD Total Capacitance	$C_{T(PD)}$	$V_R=5\text{V}$, $f=1\text{MHz}$	—	—	20	pF

Examples of Typical Characteristics

Optical Output Power vs. Forward Current

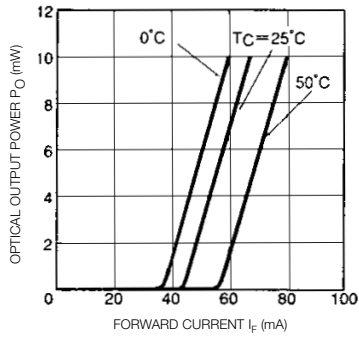

Forward Current vs. Forward Voltage

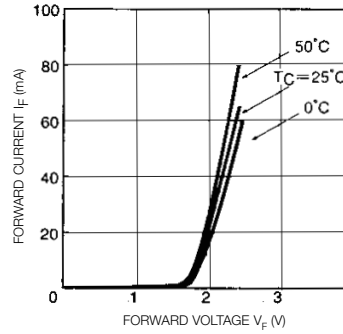

Case Temperature Dependence of Threshold Current

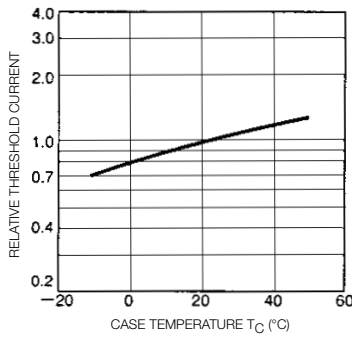

Case Temperature Dependence of Lasing Wavelength

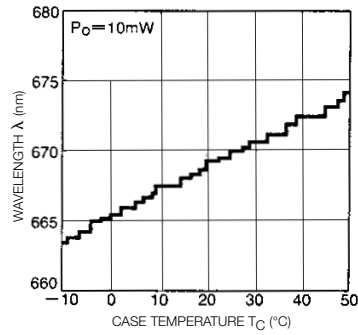

Far-field Patterns

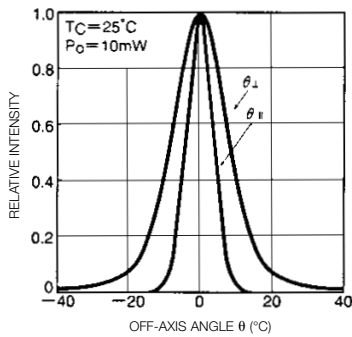

Lasing Spectrum

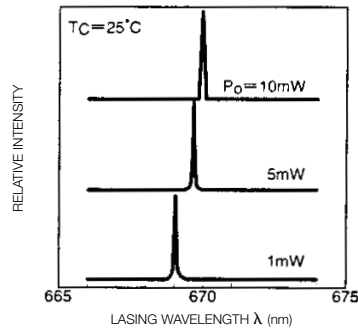

Monitor current vs. Optical Output Power

