

# Agilent HLMP-LD16/HLMP-MD16 4 mm Precision Optical Performance Red Oval LEDs Data Sheet

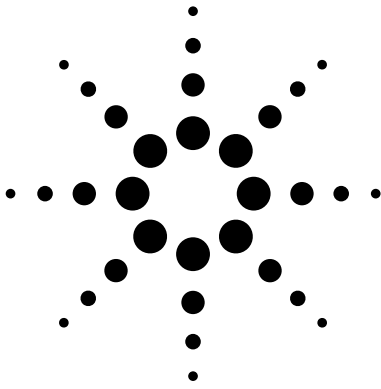

## Description

These Precision Optical Performance Oval LEDs are specifically designed for Full Color/Video and Passenger Information signs. The oval shaped radiation pattern ( $50^\circ \times 100^\circ$ ) and high luminous intensity ensure that these devices are excellent for wide field of view outdoor applications where a wide viewing angle and readability in sunlight are essential. These lamps have very smooth, matched radiation patterns ensuring consistent color mixing in full color applications, message uniformity across the viewing angle of the sign.

High efficiency LED materials are used in these lamps: Aluminum Indium Gallium Phosphide (AlInGaP) for Red color. The higher performance AlInGaP II is used. Each lamp is made with an advanced optical grade epoxy offering superior high temperature and high moisture resistance in outdoor applications. The package epoxy contains both UV-a and UV-b inhibitors to reduce the effects of long term exposure to direct sunlight.

Designers can select parallel (where the axis of the leads is parallel to the wide axis of the oval radiation pattern) or perpendicular orientation. Both of the lamps are red diffused-tinted.

## Features

- High brightness material  
AlInGaP  
630 nm Red
- Viewing angles:  
major axis  $100^\circ$   
minor axis  $50^\circ$
- Well defined spatial radiation pattern
- Superior resistance to moisture

## Applications

- Commercial outdoor advertising
- Full color signs



## Device Selection Guide AlInGaP2

Part Number	Color Dominant Wavelength $\lambda_d$ (nm) Typ.	Luminous Intensity $I_v$ (mcd) at 20 mA		Tinting Type	Leadframe Orientation	Package Drawing
		Min.	Max.			
HLMP-MD16-MQ000	Red 630	450	1730	Red	Perpendicular	A
HLMP-MD16-MQT00	Red 630	450	1730	Red	Perpendicular	A
HLMP-LD16-MQ000	Red 630	450	1730	Red	Parallel	B
HLMP-LD16-MQT00	Red 630	450	1730	Red	Parallel	B
HLMP-MD16-LP000	Red 630	345	1330	Red	Perpendicular	A
HLMP-MD16-LPT00	Red 630	345	1330	Red	Perpendicular	A
HLMP-LD16-LP000	Red 630	345	1330	Red	Parallel	B
HLMP-LD16-LPT00	Red 630	345	1330	Red	Parallel	B

### Notes:

1. The luminous intensity is measured on the mechanical axis of the lamp package.
2. The optical axis is closely aligned with the package mechanical axis.
3. The dominant wavelength,  $\lambda_d$ , is derived from the CIE Chromaticity Diagram and represents the color of the lamp.

## Package Dimensions

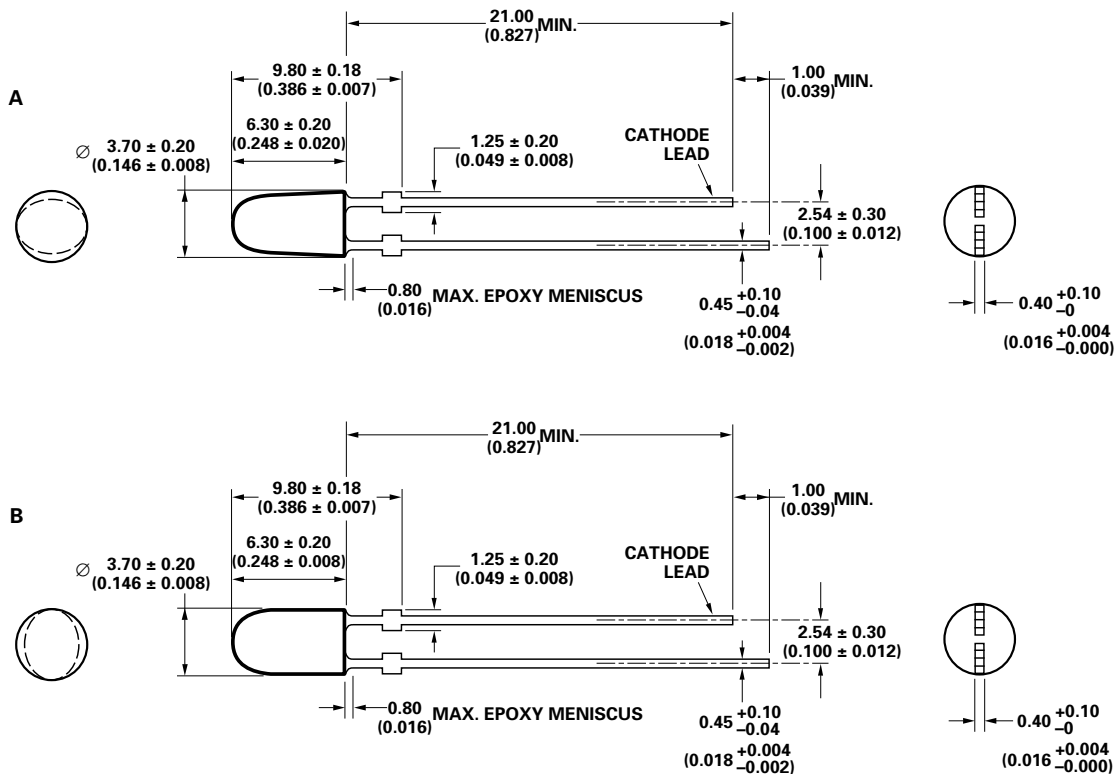

### Notes:

1. Dimensions in millimeters (inches).
2. Tolerance  $\pm 0.1$  mm unless otherwise noted.

## Part Numbering System

HLMP - x x xx - x x x xx

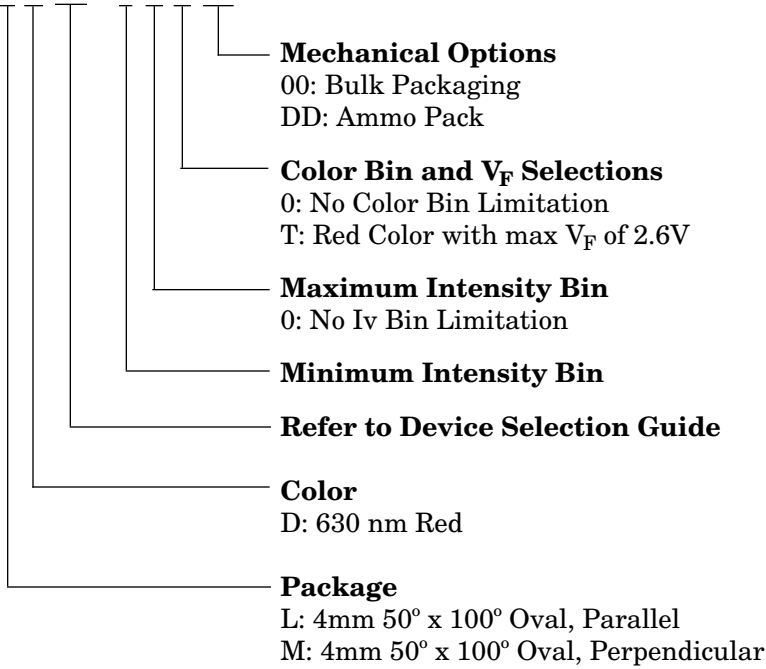

## Absolute Maximum Ratings

$T_A = 25^\circ\text{C}$

Parameter	AllnGaP Value	Units
DC Forward Current <sup>[1]</sup>	50	mA
Peak Forward Current	100	mA
Average Forward Current	30	mA
Power Dissipation	120	mW
Reverse Voltage ( $I_R = 100 \mu\text{A}$ )	5	V
LED Junction Temperature	130	$^\circ\text{C}$
Operating Temperature Range	-40 to +100	$^\circ\text{C}$
Storage Temperature Range	-40 to +120	$^\circ\text{C}$
Soldering Temperature	260 for 5 sec	$^\circ\text{C}$

### Note:

1. Derate linearly as shown in Figure 3 for temperatures above 50°C.

## Electrical/Optical Characteristics

$T_A = 25^\circ\text{C}$

Parameter	Symbol	Min.	Typ.	Max.	Units	Test Conditions
Typical Viewing Angle						
Major	$2\theta_{1/2}$		100		deg	
Minor			50			
Forward Voltage						
Red ( $\lambda_d = 630\text{ nm}$ )	$V_F$		2.0	2.4 <sup>[1]</sup>	V	$I_F = 20\text{ mA}$
Reverse Voltage						
Red	$V_R$	5	20		V	$I_R = 100\ \mu\text{A}$
Peak Wavelength						
Red ( $\lambda_d = 630\text{ nm}$ )	$\lambda_{\text{peak}}$		639		nm	Peak of Wavelength of Spectral Distribution at $I_F = 20\text{ mA}$
Spectral Halfwidth						
Red ( $\lambda_d = 630\text{ nm}$ )	$\Delta\lambda_{1/2}$		17		nm	Wavelength Width at Spectral Distribution Power Point at $I_F = 20\text{ mA}$
Capacitance						
Red	C		40		pF	$V_F = 0, F = 1\text{ MHz}$
Thermal Resistance	$R\theta_{J-PIN}$		240		$^\circ\text{C/W}$	LED Junction-to-Cathode Lead
Luminous Efficacy						
Red ( $\lambda_d = 630\text{ nm}$ )	$\eta_v$		155		lm/W	Emitted Luminous Power/ Emitted Radiant Power

### Notes:

1. For option -xxTxx, maximum forward voltage,  $V_F$  is 2.6V.
2.  $2\theta_{1/2}$  is the off-axis angle where the luminous intensity is 1/2 the on-axis intensity.
3. The radiant intensity,  $I_e$  in watts per steradian, may be found from the equation  $I_e = I_v/\eta_v$  where  $I_v$  is the luminous intensity in candelas and  $\eta_v$  is the luminous efficacy in lumens/watt.

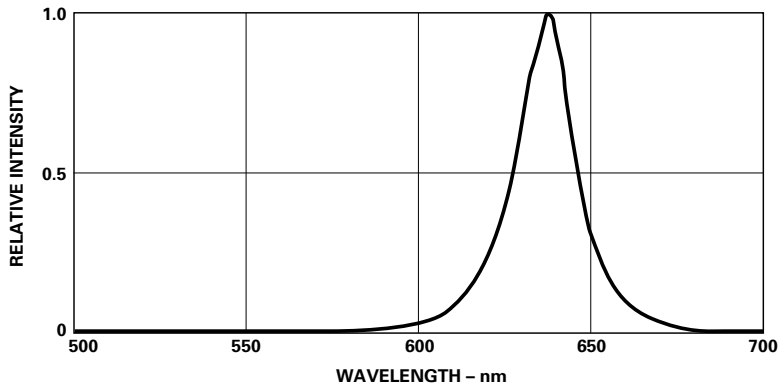

Figure 1. Relative intensity vs. wavelength.

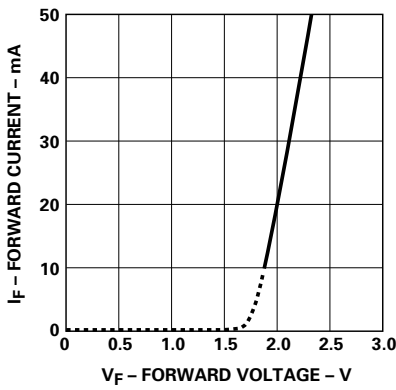

Figure 2. AllnGaP forward current vs. forward voltage.

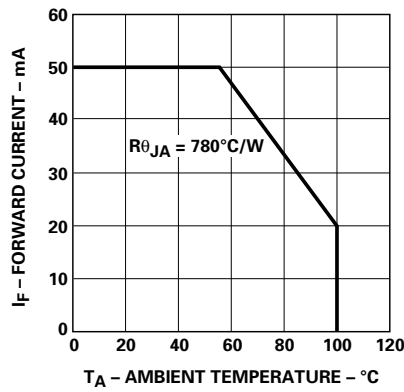

Figure 3. AllnGaP maximum forward current vs. ambient temperature.

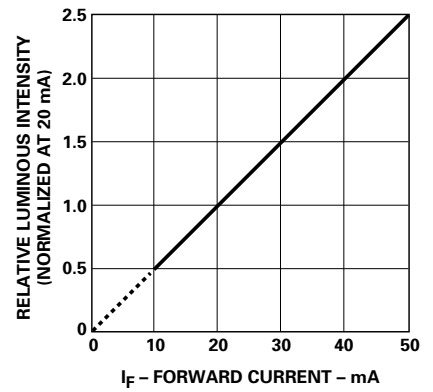

Figure 4. AllnGaP relative luminous intensity vs. forward current.

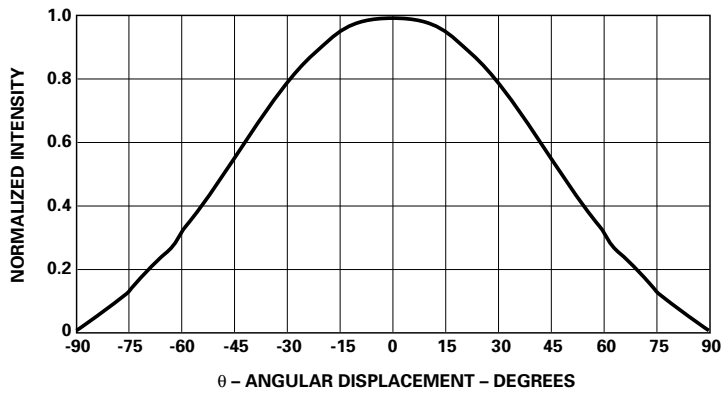

Figure 5a. Representative spatial radiation pattern – horizontal.

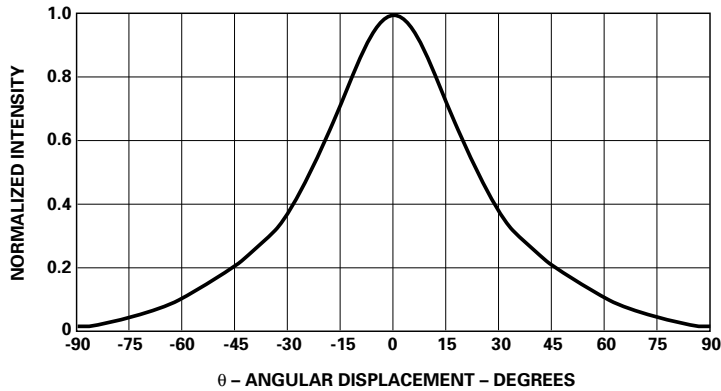

Figure 5b. Representative spatial radiation pattern – vertical.

### Intensity Bin Limits

(mcd at 20 mA)

Bin Name	Min.	Max.
L	400	520
M	520	680
N	680	880
P	880	1150
Q	1150	1500

Tolerance for each bin limit is  $\pm 15\%$ .

**Note:**

1. Bin categories are established for classification of products. Products may not be available in all bin categories.

*[www.semiconductor.agilent.com](http://www.semiconductor.agilent.com)*

Data subject to change.  
Copyright © 2001 Agilent Technologies Inc.  
October 19, 2001  
Obsoletes 5988-1854EN  
5988-4351EN



**Agilent Technologies**