

**DIGITAL CONTROLLED STEREO AUDIO PROCESSOR
WITH LOUDNESS**

- INPUT MULTIPLEXER:
3 STEREO INPUTS
- RECORD OUTPUT FUNCTION
- LOUDNESS FUNCTION
- VOLUME CONTROL IN 1dB STEPS
- INDEPENDENT LEFT AND RIGHT VOLUME CONTROL
- SOFT MUTE FUNCTION
- ALL FUNCTIONS PROGRAMMABLE VIA SERIAL I²C BUS

DESCRIPTION

The TDA7309 is a control processor with independent left and right volume control for quality audio applications. Selectable external loudness and soft mute functions are provided.

Control is accomplished by serial I²C bus micro-processor interface.

The AC signal setting is obtained by resistor net-

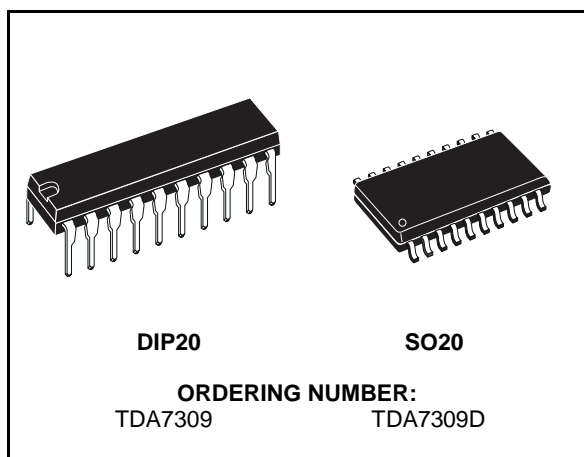

works and switches combined with operational amplifiers.

Thanks to the used BIPOLAR/CMOS Technology, Low Distortion, Low Noise and Low DC stepping are obtained.

BLOCK DIAGRAM

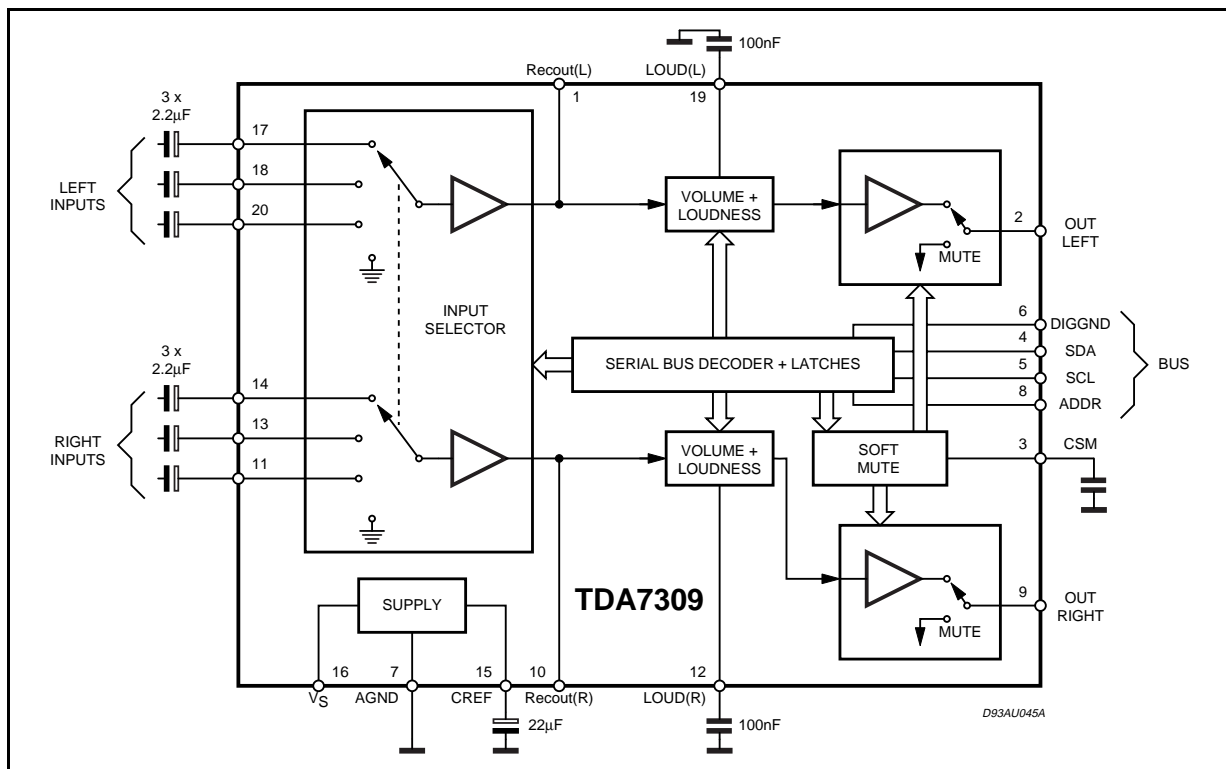

PIN CONNECTION (Top View)

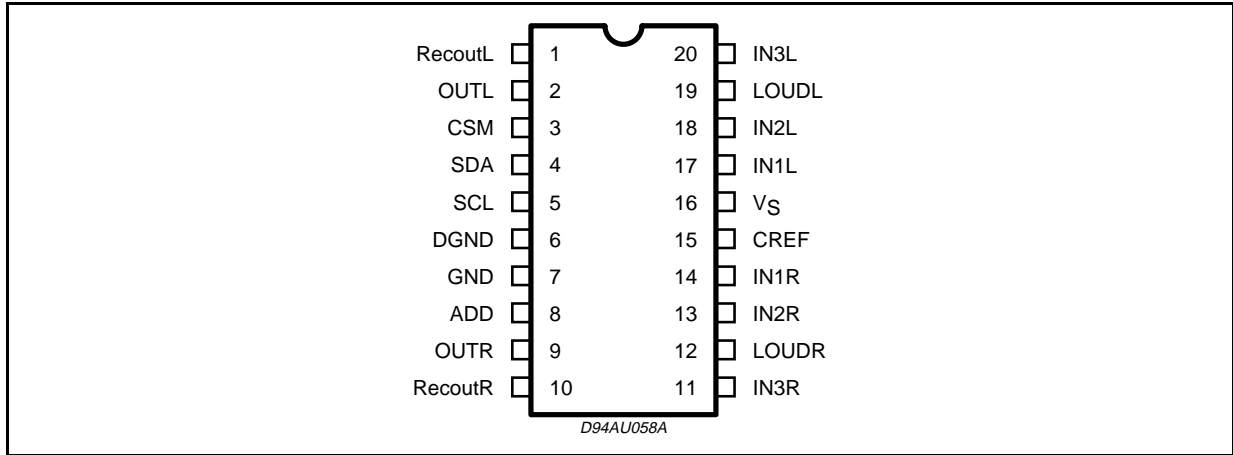

ABSOLUTE MAXIMUM RATINGS

Symbol	Parameter	Value	Unit
V_S	Operating Supply Voltage	10.5	V
T_{amb}	Operating Ambient Temperature	-40 to 85	°C
T_{stg}	Storage Temperature Range	-55 to +150	°C

QUICK REFERENCE DATA

Symbol	Parameter	Test Condition	Min.	Typ.	Max.	Unit
V_S	Operating Supply Voltage		6		10	V
V_{CL}	Max. Input Signal Handling		2			V _{rms}
THD	Total Harmonic Distortion	$V = 1V_{rms}, f = 1KHz$		0.01	0.1	%
S/N	Signal to Noise Ratio			106		dB
Sc	Channel Separation $f = 1KHz$			100		dB
	Volume Control 1.0dB step		-95		0	dB
	Soft Mute Attenuation			60		dB
	Direct Mute Attenuation			100		dB

TEST CIRCUIT

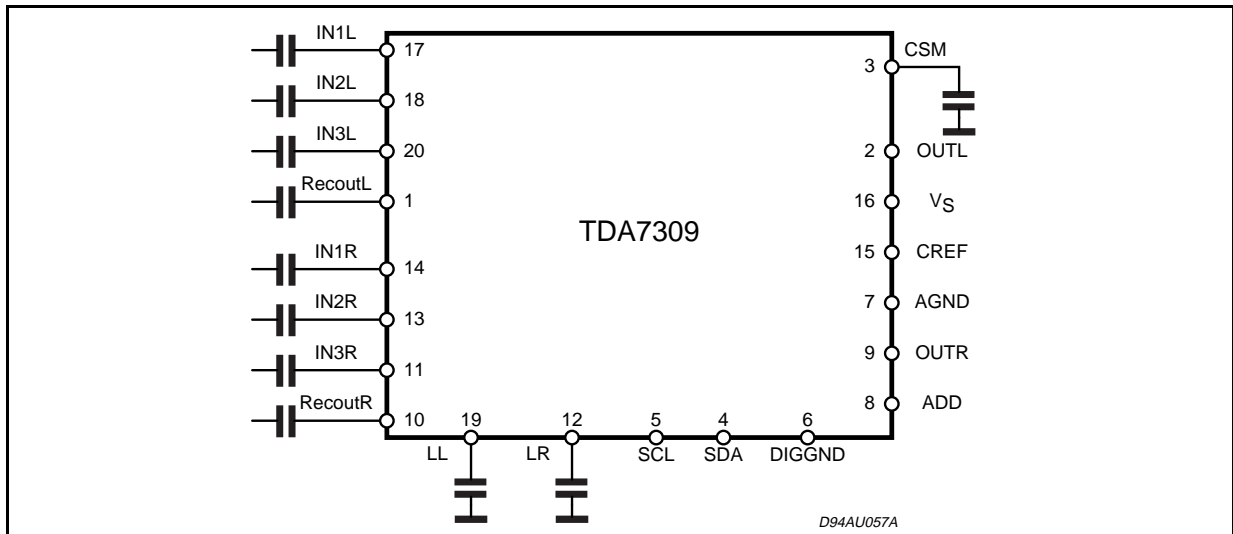

THERMAL DATA

Symbol	Parameter	SO20	DIP20	Unit
$R_{th\ j-pins}$	Thermal resistance Junction to Pins	150	100	°C/W

ELECTRICAL CHARACTERISTICS (Refer to the test circuit, $T_{amb} = 25^{\circ}\text{C}$, $V_S = 9\text{V}$, $R_L = 10\text{K}\Omega$, $R_G = 50\Omega$, all controls flat ($G = 0$), $f = 1\text{KHz}$ unless otherwise specified.)

Symbol	Parameter	Test Condition	Min.	Typ.	Max.	Unit
--------	-----------	----------------	------	------	------	------

SUPPLY

V_S	Supply Voltage		5 (*)	9	10	V
I_S	Supply Current			7	10	mA
SVR	Ripple Rejection		60	85		dB

INPUT SELECTORS

R_I	Input Resistance		35	50	65	K Ω
S_{in}	Input Separation		80	90		dB

VOLUME CONTROL

C_{RANGE}	Control Range			92		dB
A_{VMAX}	Max. Attenuation		87	92	95	dB
A_{STEP}	Step resolution		0.5	1	1.5	dB
E_A	Attenuation Set Error	$A_V = 0$ to -24dB	-1.2		1.2	dB
		$A_V = -24$ to -56dB	-3		2	dB
E_T	Tracking Error				2	dB
V_{DC}	DC Steps	adjacent attenuation steps		0	3	mV
		from 0dB to A_V max.		0.5	5	mV
A_{mute}	Output Mute Attenuation		80	100		dB

SOFT MUTE

T_d	Delay Time	$C_{smute} = 22\text{nF}$ 0 to -20dB Fast Mode Slow Mode		1 20		ms ms
-------	------------	---	--	---------	--	----------

AUDIO OUTPUTS

V_{CLIP}	Clipping Level	$d = 0.3\%$	2	2.6		V _{rms}
R_L	Output Load Resistance		2			K Ω
R_{out}	Output Impedance		100	200	300	Ω
V_{DC}	DC Voltage Level			3.8		V

GENERAL

e_{NO}	Output Noise	BW = 20-20KHz, flat output muted all gains = 0dB		2.5 5	15	μV μV
		A curve all gains = 0dB		3		μV
		E_t	Total Tracking Error	$A_V = 0$ to -24dB $A_V = -24$ to -56dB	0 0	1 2
S/N	Signal to Noise Ratio	all gains = 0dB; $V_O = 1\text{V}_{rms}$	95	106		dB
d	Distortion			0.01	0.1	%
S_C	Channel Separation		80	100		dB

BUS INPUTS

V_{IL}	Input Low Voltage				1	V
V_{IH}	Input High Voltage		3			V
I_{IN}	Input Current	$V_{in} = 0.4\text{V}$	-5		+5	μA
V_O	Output Voltage SDA Acknowledge	$I_O = 1.6\text{mA}$		0.4	0.8	V

(*) Hedevice work until 5V but no guarantee about SVR

Figure 1: Noise vs. volume setting.

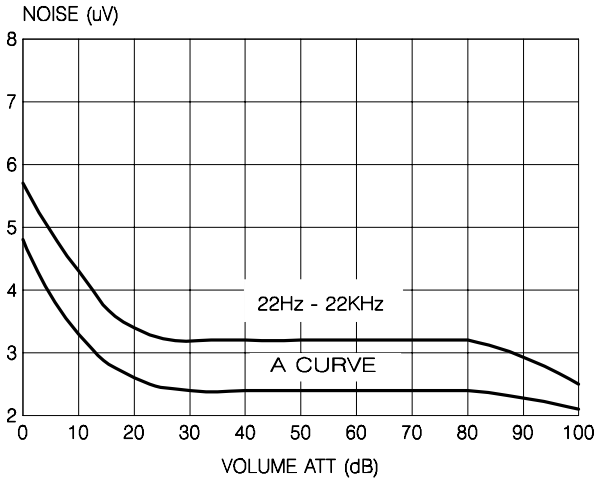

Figure 2: SVRR vs. frequency.

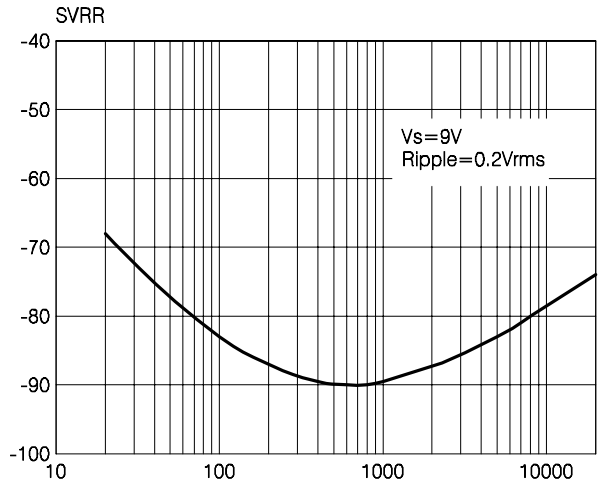

Figure 3: THD vs. frequency

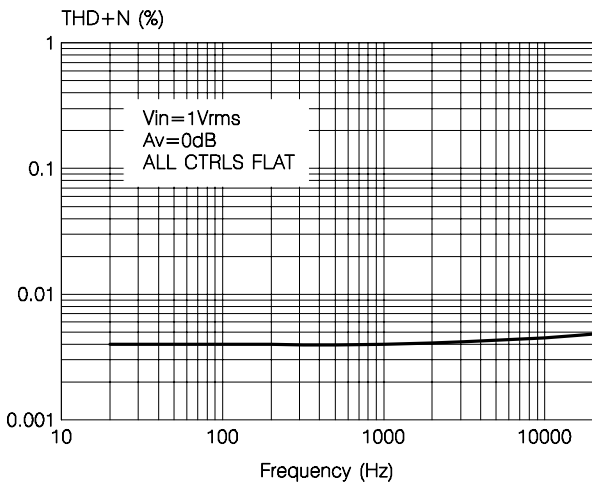

Figure 4: THD vs. RLOAD.

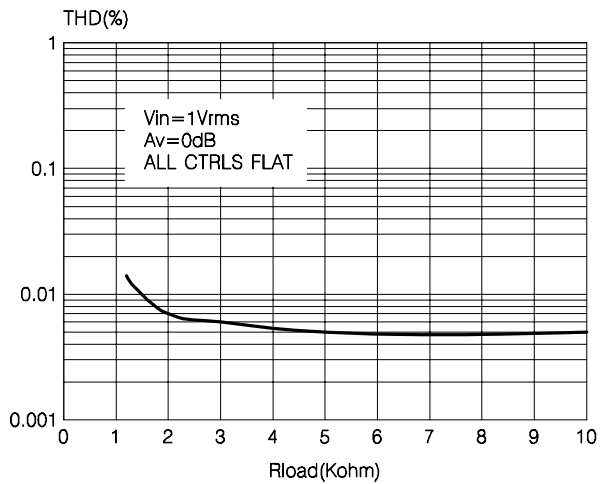

Figure 5: Channel separation vs. frequency.

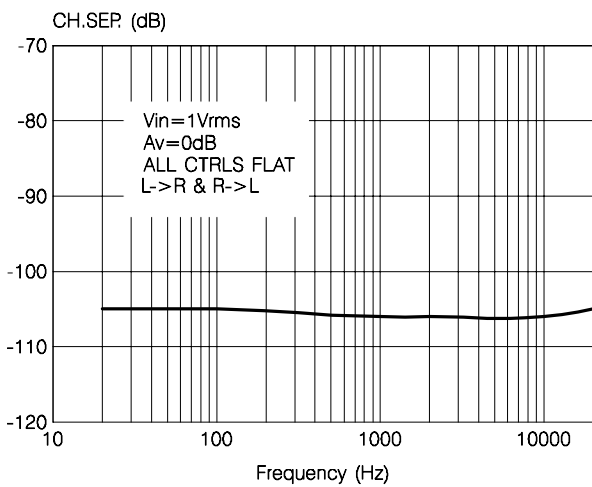

Figure 6: Output clip level vs. Supply Voltage.

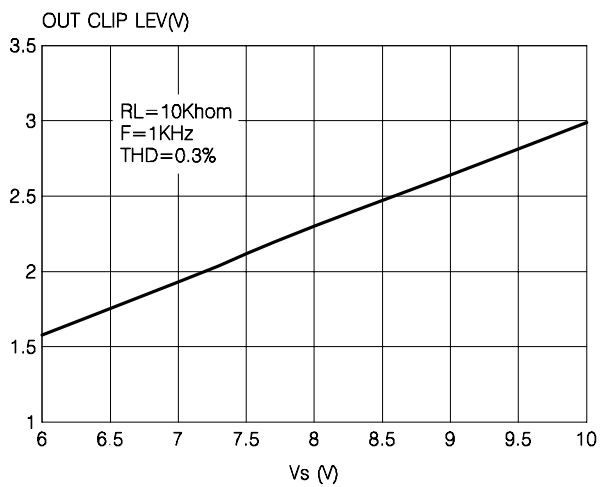

Figure 7: Quiescent current vs. supply voltage.

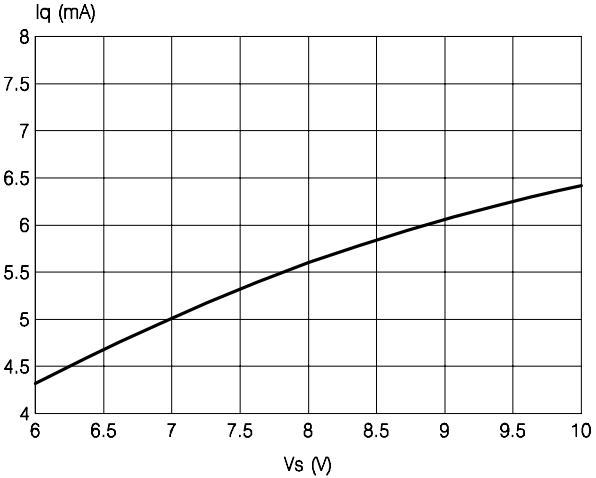

Figure 8: Loudness vs. Volume Attenuation.

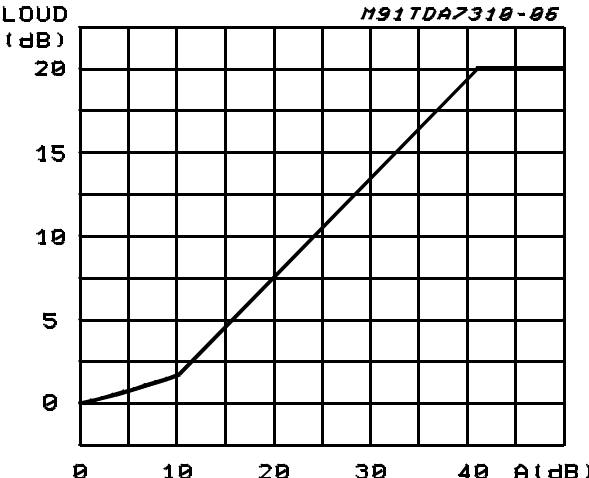

Figure 9: Loudness vs. Frequency (CLOUD = 100nF) vs. Volume

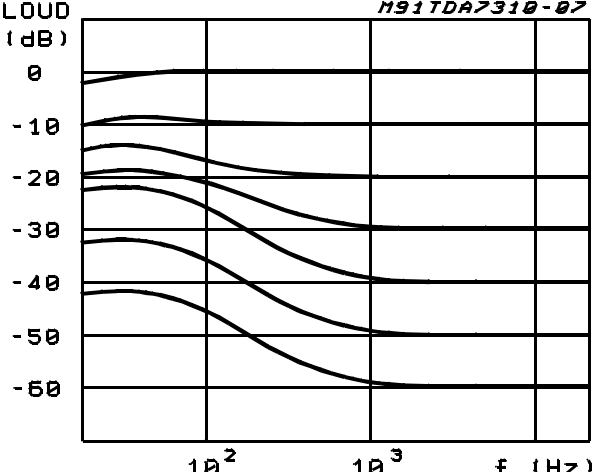
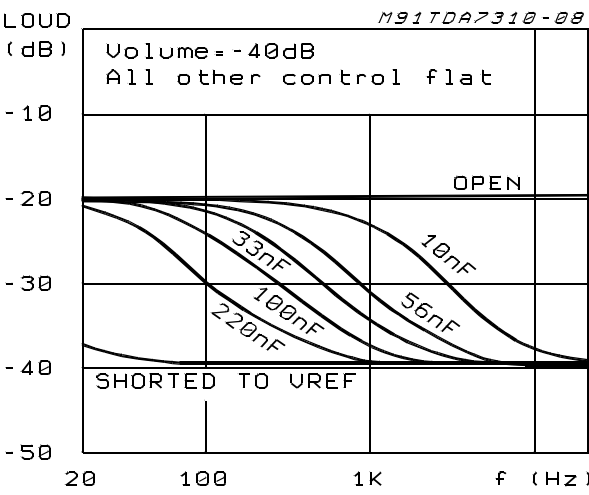

Figure 10: Loudness vs. External Capacitors



I²C BUS INTERFACE

Data transmission from microprocessor to the TDA7313 and viceversa takes place thru the 2 wires I²C BUS interface, consisting of the two lines SDA and SCL (pull-up resistors to positive supply voltage must be connected).

Data Validity

As shown in fig. 11, the data on the SDA line must be stable during the high period of the clock. The HIGH and LOW state of the data line can only change when the clock signal on the SCL line is LOW.

Start and Stop Conditions

As shown in fig. 12 a start condition is a HIGH to LOW transition of the SDA line while SCL is HIGH. The stop condition is a LOW to HIGH transition of the SDA line while SCL is HIGH.

Byte Format

Every byte transferred on the SDA line must contain 8 bits. Each byte must be followed by an acknowledge bit. The MSB is transferred first.

Acknowledge

The master (μ P) puts a resistive HIGH level on the SDA line during the acknowledge clock pulse (see fig. 13). The peripheral (audioprocessor) that acknowledges has to pull-down (LOW) the SDA line during the acknowledge clock pulse, so that the SDA line is stable LOW during this clock pulse.

The audioprocessor which has been addressed has to generate an acknowledge after the reception of each byte, otherwise the SDA line remains at the HIGH level during the ninth clock pulse time. In this case the master transmitter can generate the STOP information in order to abort the transfer.

Transmission without Acknowledge

Avoiding to detect the acknowledge of the audioprocessor, the μ P can use a simpler transmission: simply it waits one clock without checking the slave acknowledging, and sends the new data.

This approach of course is less protected from misworking and decreases the noise immunity.

Figure 11: Data Validity on the I²C BUS

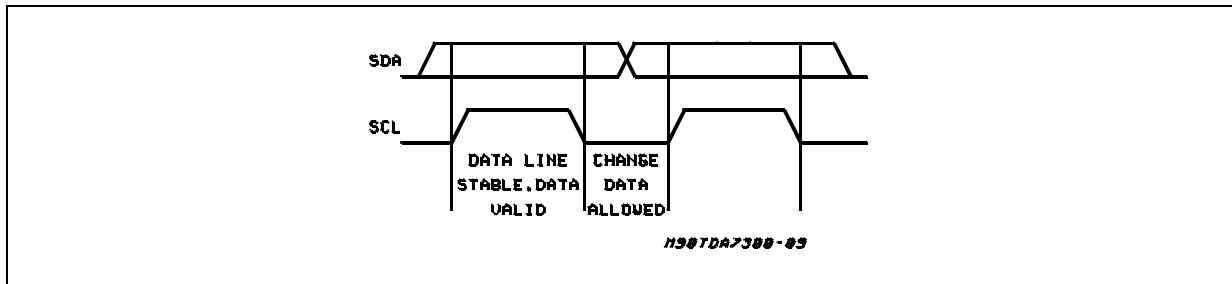

Figure 12: Timing Diagram of I²C BUS

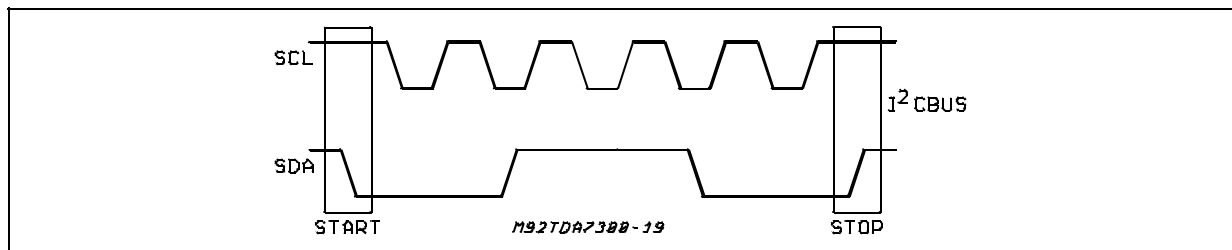
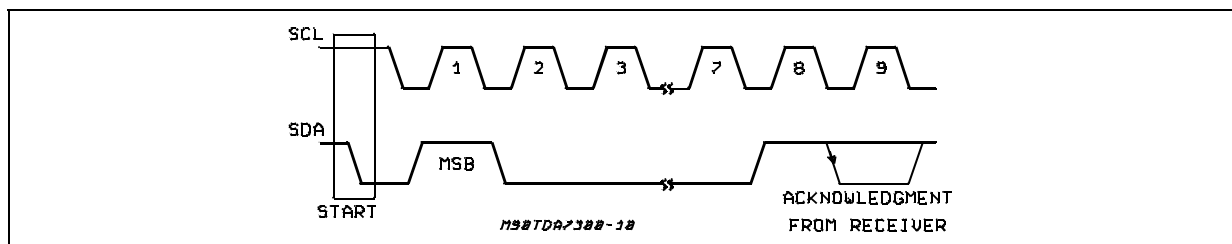

Figure 13: Acknowledge on the I²C BUS



SDA, SCL I²C BUS TIMING

Symbol	Parameter	Min.	Typ.	Max.	Unit
f _{SCL}	SCL clock frequency	0		400	kHz
t _{BUF}	Bus free time between a STOP and START condition	1.3			μs
t _{HD:STA}	Hold time (repeated) START condition. After this period, the first clock pulse is generated	0.6			μs
t _{LOW}	LOW period of the SCL clock	1.3			μs
t _{HIGH}	HIGH period of the SCL clock	0.6			μs
t _{SU:STA}	Set-up time for a repeated START condition	0.6			μs
t _{HD:DA}	Data hold time	0.300			μs
t _{SU:DAT}	Data set-up time	100			ns
t _R	Rise time of both SDA and SCL signals	20		300	ns (*)
t _F	Fall time of both SDA and SCL signals	20		300	ns (*)
t _{SU:STO}	Set-up time for STOP condition	0.6			μs

All values referred to V_{IH.min.} and V_{IL.max.} levels
 (*) Must be guaranteed by the I²C BUS master.

Definition of timing on the I²C-bus

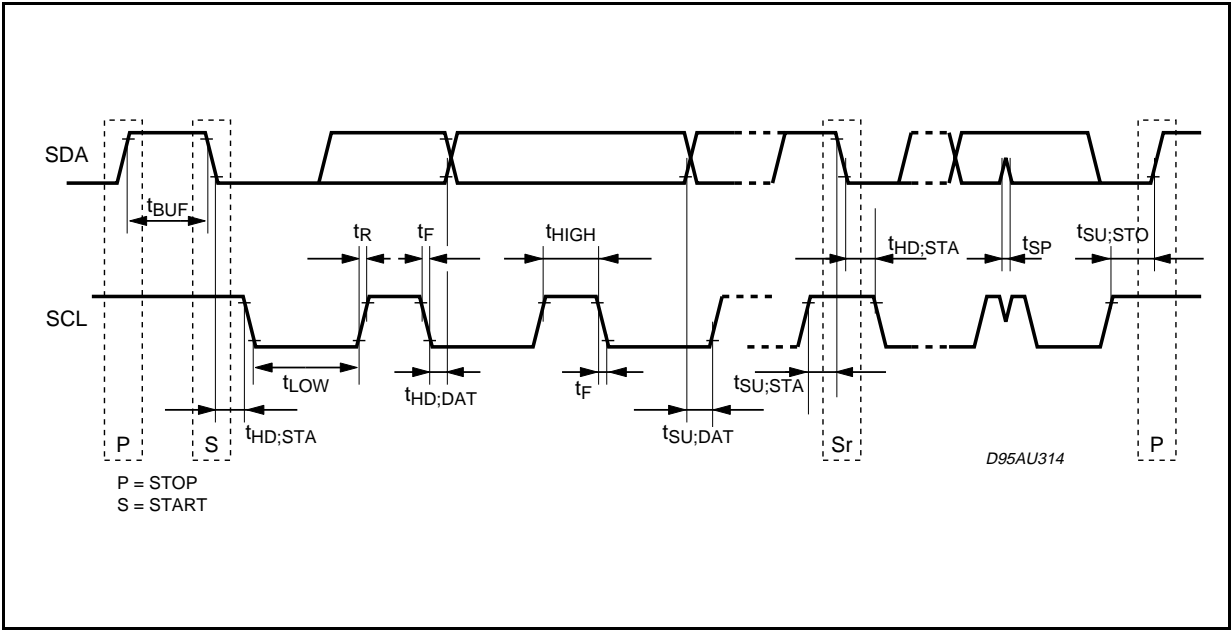

TDA7309

SOFTWARE SPECIFICATION

Interface Protocol

The interface protocol comprises:

- A start condition (s)
- A chip address byte, containing the TDA7309

address (the 8th bit of the byte must be 0). The TDA7309 must always acknowledge at the end of each transmitted byte.

- A sequence of data (N-bytes + acknowledge)
- A stop condition (P)

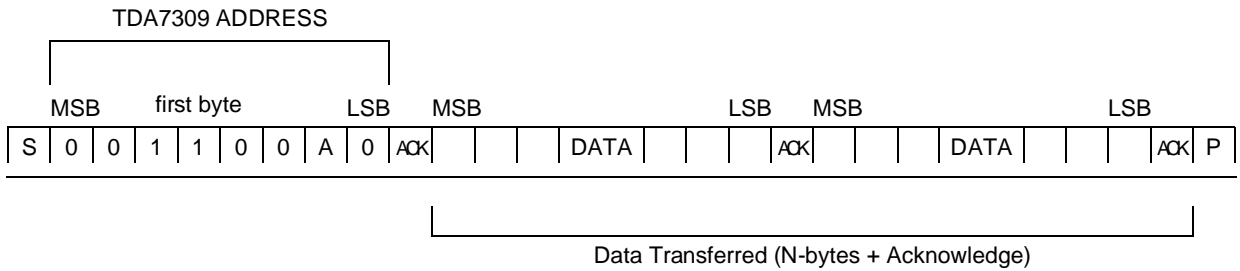

ACK = Acknowledge
 S = Start
 P = Stop

MAX CLOCK SPEED 100kbits/s

SOFTWARE SPECIFICATION

Chip address

MSB				LSB				
0	0	1	1	0	0	1	0	pin address open
0	0	1	1	0	0	0	0	pin address close to ground

FUNCTION CODES

	MSB	F6	F5	F4	F3	F2	F1	LSB
VOLUME	0	X	X	X	X	X	X	X
MUTE/LOUD	1	0	0	X	X	X	X	X
INPUTS	1	0	1	X	X	X	X	X
CHANNEL	1	1	0	X	X	X	X	X

CHANNEL ABILITATION CODES

MSB	F6	F5	F4	F3	F2	F1	LSB	FUNCTION
1	1	0						channel
			X	X	X	0	0	RIGHT
			X	X	X	0	1	LEFT
			X	X	X	1	0	BOTH
			X	X	X	1	1	BOTH

Power on reset condition

1 1 1 1 1 1 1 0

VOLUME CODES

MSB	F6	F5	F4	F3	F2	F1	LSB	FUNCTION
0								step 1dB
					0	0	0	0dB
					0	0	1	-1dB
					0	1	0	-2dB
					0	1	1	-3dB
					1	0	0	-4dB
					1	0	1	-5dB
					1	1	0	-6dB
					1	1	1	-7dB
0								step 8dB
	0	0	0	0				0dB
	0	0	0	1				-8dB
	0	0	1	0				-16dB
	0	0	1	1				-24dB
	0	1	0	0				-32dB
	0	1	0	1				-40dB
	0	1	1	0				-48dB
	0	1	1	1				-56dB
	1	0	0	0				-64dB
	1	0	0	1				-72dB
	1	0	1	0				-80dB
	1	0	1	1				-88dB
	1	1	X	X				MUTE

MUTE LOUDNESS CODES

MSB	F6	F5	F4	F3	F2	F1	LSB	FUNCTION
1	0	0						mute/loud
			X			0	0	slow soft mute on
			X			0	1	fast soft mute on
						1		soft mute off
					1			LOUD OFF
			X	0	0			loud on (10dB)
			X	1	0			loud on (20dB)

INPUT MULTIPLEXER CODES

MSB	F6	F5	F4	F3	F2	F1	LSB	FUNCTION
1	0	1						inputs
			X	X	X	0	0	MUTE
			X	X	X	0	1	IN2
			X	X	X	1	0	IN3
			X	X	X	1	1	IN1

Purchase of I²C Components of SGS-THOMSON Microelectronics, conveys a license under the Philips I²C Patent Rights to use these components in an I²C system, provided that the system conforms to the I²C Standard Specifications as defined by Philips.

SO20 PACKAGE MECHANICAL DATA

DIM.	mm			inch		
	MIN.	TYP.	MAX.	MIN.	TYP.	MAX.
A			2.65			0.104
a1	0.1		0.3	0.004		0.012
a2			2.45			0.096
b	0.35		0.49	0.014		0.019
b1	0.23		0.32	0.009		0.013
C		0.5			0.020	
c1	45 (typ.)					
D	12.6		13.0	0.496		0.512
E	10		10.65	0.394		0.419
e		1.27			0.050	
e3		11.43			0.450	
F	7.4		7.6	0.291		0.299
L	0.5		1.27	0.020		0.050
M			0.75			0.030
S	8 (max.)					

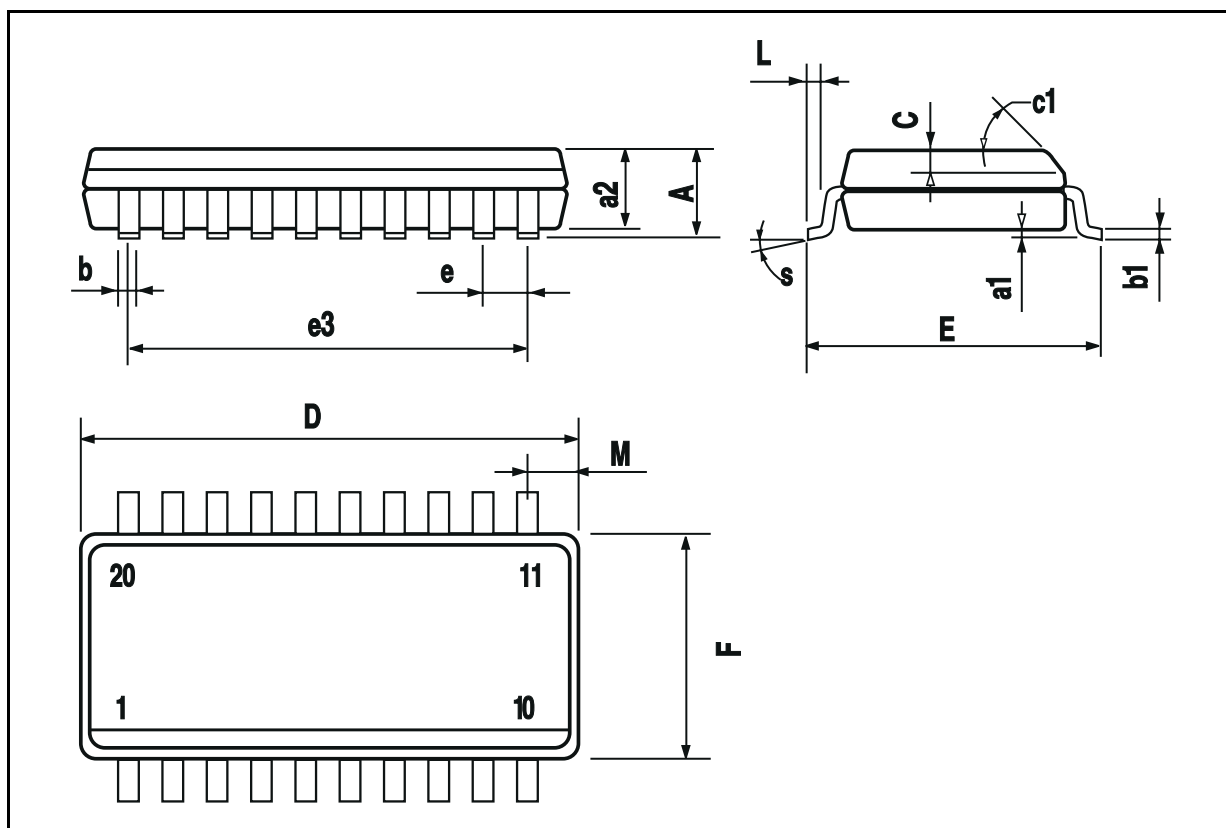

DIP20 PACKAGE MECHANICAL DATA

DIM.	mm			inch		
	MIN.	TYP.	MAX.	MIN.	TYP.	MAX.
a1	0.254			0.010		
B	1.39		1.65	0.055		0.065
b		0.45			0.018	
b1		0.25		0.010		
D			25.4			1.000
E		8.5			0.335	
e		2.54			0.100	
e3		22.86			0.900	
F			7.1			0.280
I			3.93			0.155
L		3.3			0.130	
Z			1.34			0.053

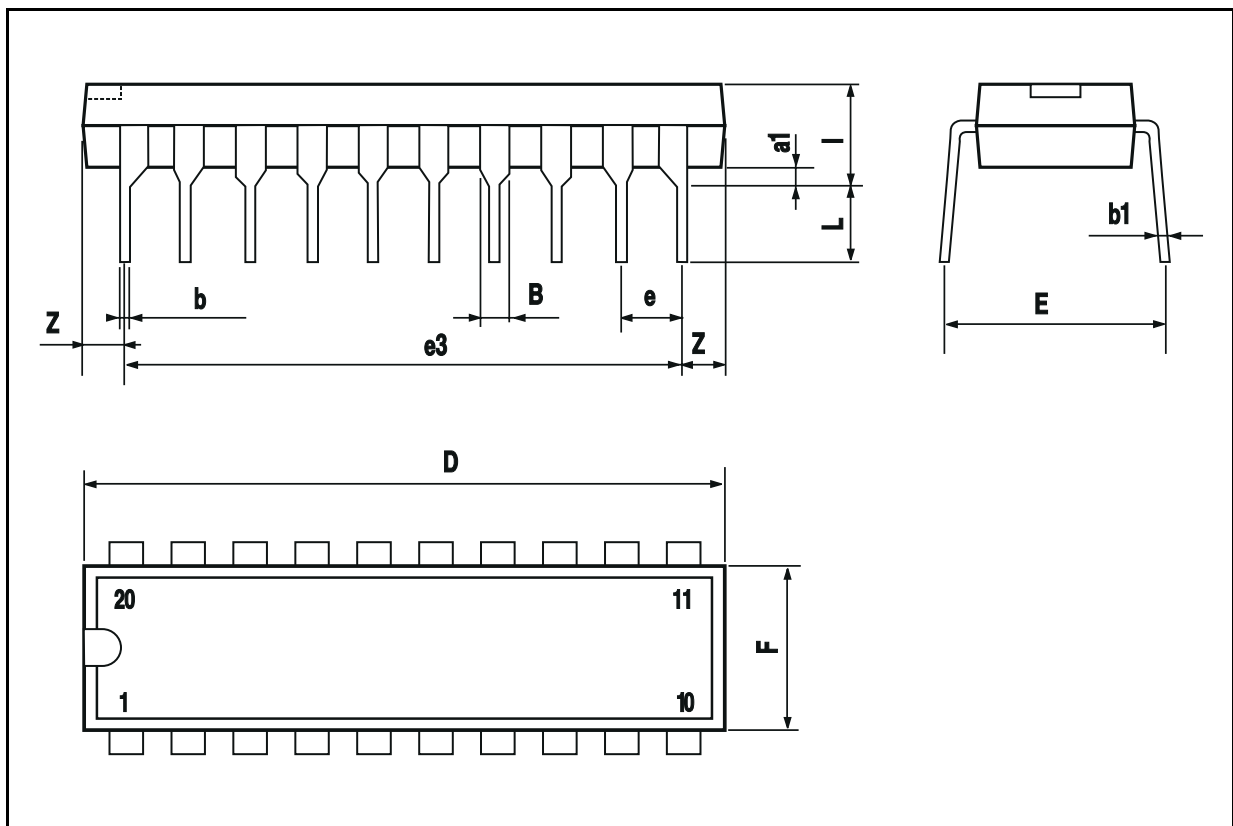

Information furnished is believed to be accurate and reliable. However, SGS-THOMSON Microelectronics assumes no responsibility for the consequences of use of such information nor for any infringement of patents or other rights of third parties which may result from its use. No license is granted by implication or otherwise under any patent or patent rights of SGS-THOMSON Microelectronics. Specification mentioned in this publication are subject to change without notice. This publication supersedes and replaces all information previously supplied. SGS-THOMSON Microelectronics products are not authorized for use as critical components in life support devices or systems without express written approval of SGS-THOMSON Microelectronics.

© 1997 SGS-THOMSON Microelectronics – Printed in Italy – All Rights Reserved

SGS-THOMSON Microelectronics GROUP OF COMPANIES

Australia - Brazil - Canada - China - France - Germany - Hong Kong - Italy - Japan - Korea - Malaysia - Malta - Morocco - The Netherlands - Singapore - Spain - Sweden - Switzerland - Taiwan - Thailand - United Kingdom - U.S.A.