

PREPARED BY: _____	DATE _____	SHARP	SPEC No. LD-19606
APPROVED BY: _____	DATE _____		FILE No. _____
			ISSUE: June.,06 , 2007
			PAGE : 23pages
		AVC LIQUID CRYSTAL DISPLAY GROUP SHARP CORPORATION SPECIFICATION	APPLICABLE GROUP AVC LIQUID CRYSTAL DISPLAY GROUP

DEVICE SPECIFICATION FOR

TFT - LCD module

 MODEL No. LK520D3LZ18

CUSTOMER'S APPROVAL

DATE _____

BY _____

PRESENTED

BY *Makoto Takeda*

M.TAKEDA
 General Manager
 MODULE DEVELOPMENT DEPT.
 DEVELOPMENT CENTER
 AVC LIQUID CRYSTAL DISPLAY GROUP
 SHARP CORPORATION

RECORDS OF REVISION

www.DataSheet4U.com

MODEL No. : LK520D3LZ18

SPEC No. : LD-19606

SPEC No.	DATE	REVISED No.	PAGE	SUMMARY	NOTE
LD-19606	2007.06.06	-	-	-	1st Issue

1. Application

This specification applies to the color 52.0" TFT-LCD module LK520D3LZ18.

- * These specification sheets are proprietary products of SHARP CORPORATION ("SHARP") and include materials protected under copyright of SHARP. Do not reproduce or cause any third party to reproduce them in any form or by any means, electronic or mechanical, for any purpose, in whole or in part, without the express written permission of SHARP.
- * In case of using the device for applications such as control and safety equipment for transportation (aircraft, trains, automobiles, etc.), rescue and security equipment and various safety related equipment which require higher reliability and safety, take into consideration that appropriate measures such as fail-safe functions and redundant system design should be taken.
- * Do not use the device for equipment that requires an extreme level of reliability, such as aerospace applications, telecommunication equipment (trunk lines), nuclear power control equipment and medical or other equipment for life support.
- * SHARP assumes no responsibility for any damage resulting from the use of the device that does not comply with the instructions and the precautions specified in these specification sheets.
- * Contact and consult with a SHARP sales representative for any questions about this device.

2. Overview

This module is a color active matrix LCD module incorporating amorphous silicon TFT (Thin Film Transistor). It is composed of a color TFT-LCD panel, driver ICs, control circuit, power supply circuit, inverter circuit and back light system etc. Graphics and texts can be displayed on a 1920 × RGB × 1080 dots panel with 16,777,216 colors by using LVDS (Low Voltage Differential Signaling) to interface, +12V of DC supply voltages.

This module also includes the DC/AC inverter to drive the CCFT. (+24V of DC supply voltage)

And in order to improve the response time of LCD, this module applies the Over Shoot driving (O/S driving) technology for the control circuit. In the O/S driving technology, signals are being applied to the Liquid Crystal according to a pre-fixed process as an image signal of the present frame when a difference is found between image signal of the previous frame and that of the current frame after comparing them.

With this technology, image signals can be set so that liquid crystal response completes within one frame. As a result, motion blur reduces and clearer display performance can be realized.

3. Mechanical Specifications

Parameter	Specifications	Unit
Display size	132.174 (Diagonal)	cm
	52.0 (Diagonal)	inch
Active area	1152.0(H) x 648.0 (V)	mm
Pixel Format	1920(H) x 1080(V) (1pixel = R + G + B dot)	pixel
Pixel pitch	0.600(H) x 0.600 (V)	mm
Pixel configuration	R, G, B vertical stripe	
Display mode	Normally black	
Unit Outline Dimensions (*1)	1219.0(W) x 706.7(H) x 64.6(D)	mm
Mass	21.0 ±1.0	kg
Surface treatment	Anti glare Hard coating: 2H	

(*1) Outline dimensions are shown in Fig.1 (excluding protruding portion)

4. Input Terminals

4.1. TFT panel driving

CN1 (Interface signals and +12V DC power supply) (Shown in Fig.1)

www.DataSheet4U.com

Using connector : FI-RE51S-HF (Japan Aviation Electronics Ind. , Ltd.)

Mating connector : FI-RE51HL, FI-RE51CL (Japan Aviation Electronics Ind. , Ltd.)

Mating LVDS transmitter : THC63LVDM83R or equivalent device

Pin No.	Symbol	Function	Remark
1	Reserved		
2	TEST	Fix to Low level or open usually.	
3	TEST	Fix to Low level or open usually.	
4	Reserved		
5	R/L	Horizontal shift direction [Note1,2]	Pull down : (GND)
6	U/D	Vertical shift direction [Note1,2]	Pull down : (GND)
7	SELLVDS	Select LVDS data order [Note3,4]	Pull up : (3.3V)
8	TEST	Fix to Low level or open usually.	Pull down : (GND)
9	Reserved		
10	Reserved		
11	GND		
12	AIN0-	Aport (-)LVDS CH0 differential data input	
13	AIN0+	Aport (+)LVDS CH0 differential data input	
14	AIN1-	Aport (-)LVDS CH1 differential data input	
15	AIN1+	Aport (+)LVDS CH1 differential data input	
16	AIN2-	Aport (-)LVDS CH2 differential data input	
17	AIN2+	Aport (+)LVDS CH2 differential data input	
18	GND		
19	ACK-	Aport LVDS Clock signal(-)	
20	ACK+	Aport LVDS Clock signal(+)	
21	GND		
22	AIN3-	Aport (-)LVDS CH3 differential data input	
23	AIN3+	Aport (+)LVDS CH3 differential data input	
24	AIN4-	NC	
25	AIN4+	NC	
26	GND		
27	GND		
28	BIN0-	Bport (-)LVDS CH0 differential data input	
29	BIN0+	Bport (+)LVDS CH0 differential data input	
30	BIN1-	Bport (-)LVDS CH1 differential data input	
31	BIN1+	Bport (+)LVDS CH1 differential data input	
32	BIN2-	Bport (-)LVDS CH2 differential data input	
33	BIN2+	Bport (+)LVDS CH2 differential data input	
34	GND		
35	BCK-	Bport LVDS Clock signal(-)	
36	BCK+	Bport LVDS Clock signal(+)	
37	GND		
38	BIN3-	Bport (-)LVDS CH3 differential data input	
39	BIN3+	Bport (+)LVDS CH3 differential data input	
40	BIN4-	NC	
41	BIN4+	NC	
42	GND		
43	GND		
44	GND		

45	GND		
46	GND		
47	VCC	+12V Power Supply	
48	VCC	+12V Power Supply	www.DataSheet4U.com
49	VCC	+12V Power Supply	
50	VCC	+12V Power Supply	
51	VCC	+12V Power Supply	

[note]GND of a liquid crystal panel drive part has connected with a module chassis.

[Note 1] Display reversal function

Normal (Default)

R/L : L (GND) U/D: L (GND)

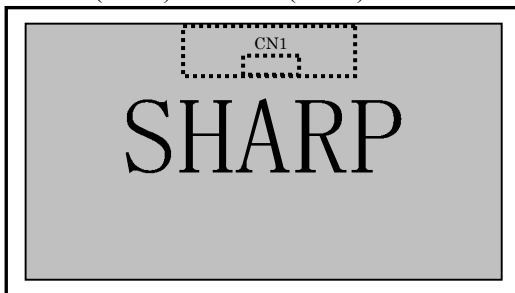

Horizontal reverse image

R/L : H (3.3V) U/D: L (GND)

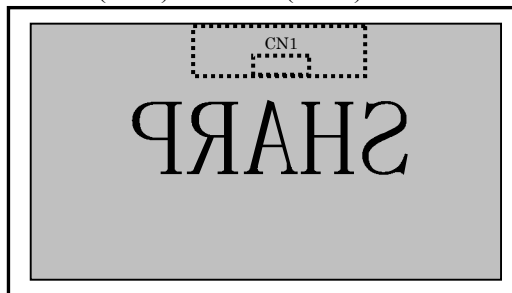

Vertical reverse image

R/L : L (GND) U/D: H (3.3V)

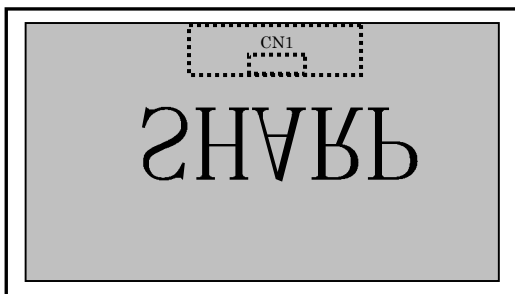

Horizontal and vertical reverse image

R/L : H(3.3V) U/D: H (3.3V)

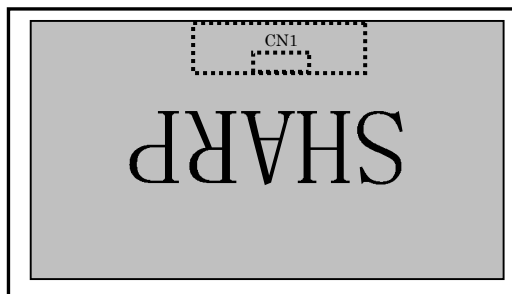

[Note 2]The equivalent circuit figure of the terminal

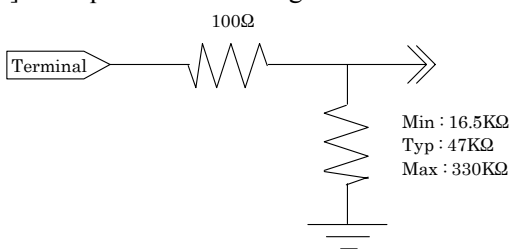

[Note 3]The equivalent circuit figure of the terminal

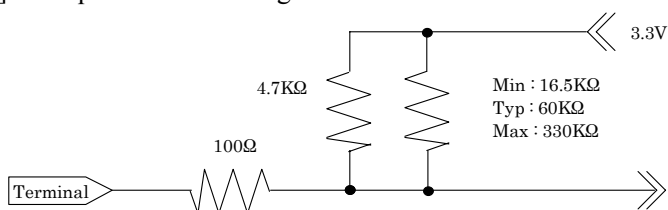

[Note 4] LVDS Data order

Transmitter		SELLVDS	
Pin No	Data	=L(GND)	=H(3.3V) or Open
51	TA0	R0(LSB)	R2
52	TA1	R1	R3
54	TA2	R2	R4
55	TA3	R3	R5
56	TA4	R4	R6
3	TA5	R5	R7(MSB)
4	TA6	G0(LSB)	G2
6	TB0	G1	G3
7	TB1	G2	G4
11	TB2	G3	G5
12	TB3	G4	G6
14	TB4	G5	G7(MSB)
15	TB5	B0(LSB)	B2
19	TB6	B1	B3
20	TC0	B2	B4
22	TC1	B3	B5
23	TC2	B4	B6
24	TC3	B5	B7(MSB)
27	TC4	NA	NA
28	TC5	NA	NA
30	TC6	DE(*)	DE(*)
50	TD0	R6	R0(LSB)
2	TD1	R7(MSB)	R1
8	TD2	G6	G0(LSB)
10	TD3	G7(MSB)	G1
16	TD4	B6	B0(LSB)
18	TD5	B7(MSB)	B1
25	TD6	NA	NA

NA: Not Available

(*)Since the display position is prescribed by the rise of DE(Display Enable)signal, please do not fix DE signal during operation at "High".

SELLVDS= High (3.3V) or OPEN

www.DataSheet4U.com

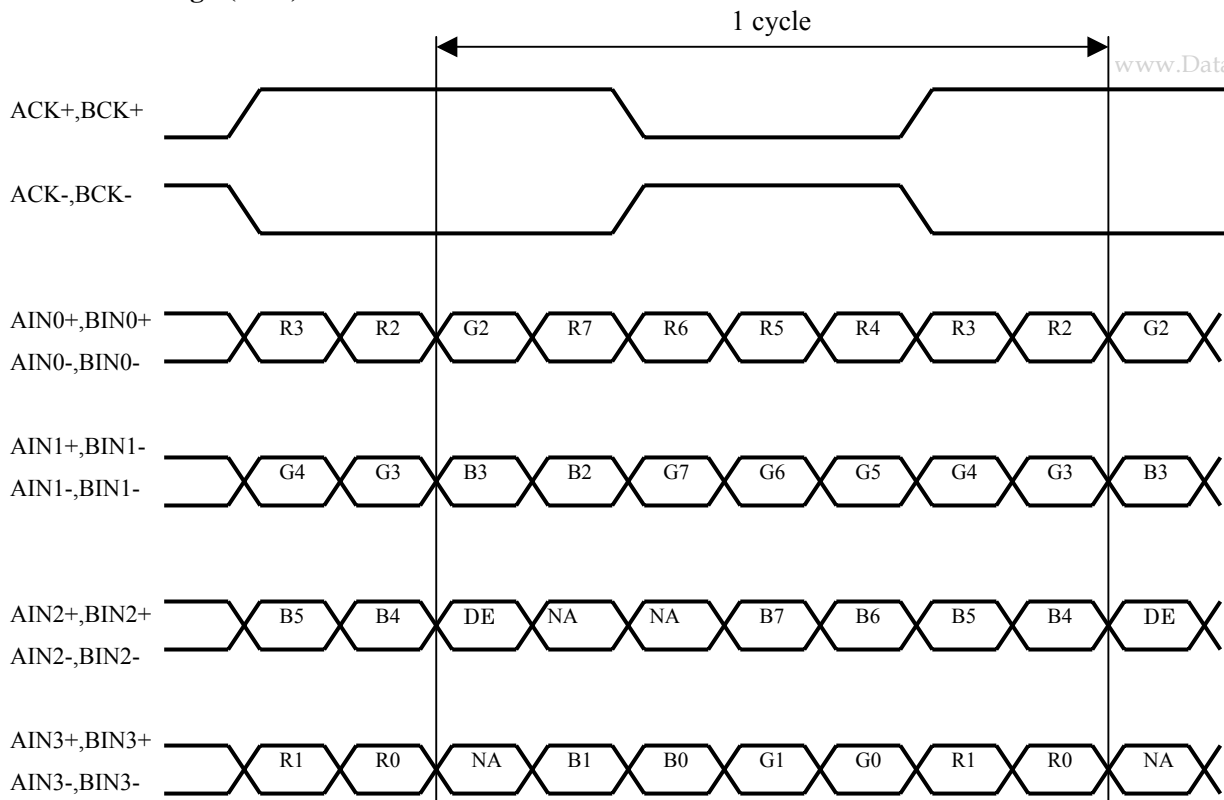

SELLVDS= Low (GND)

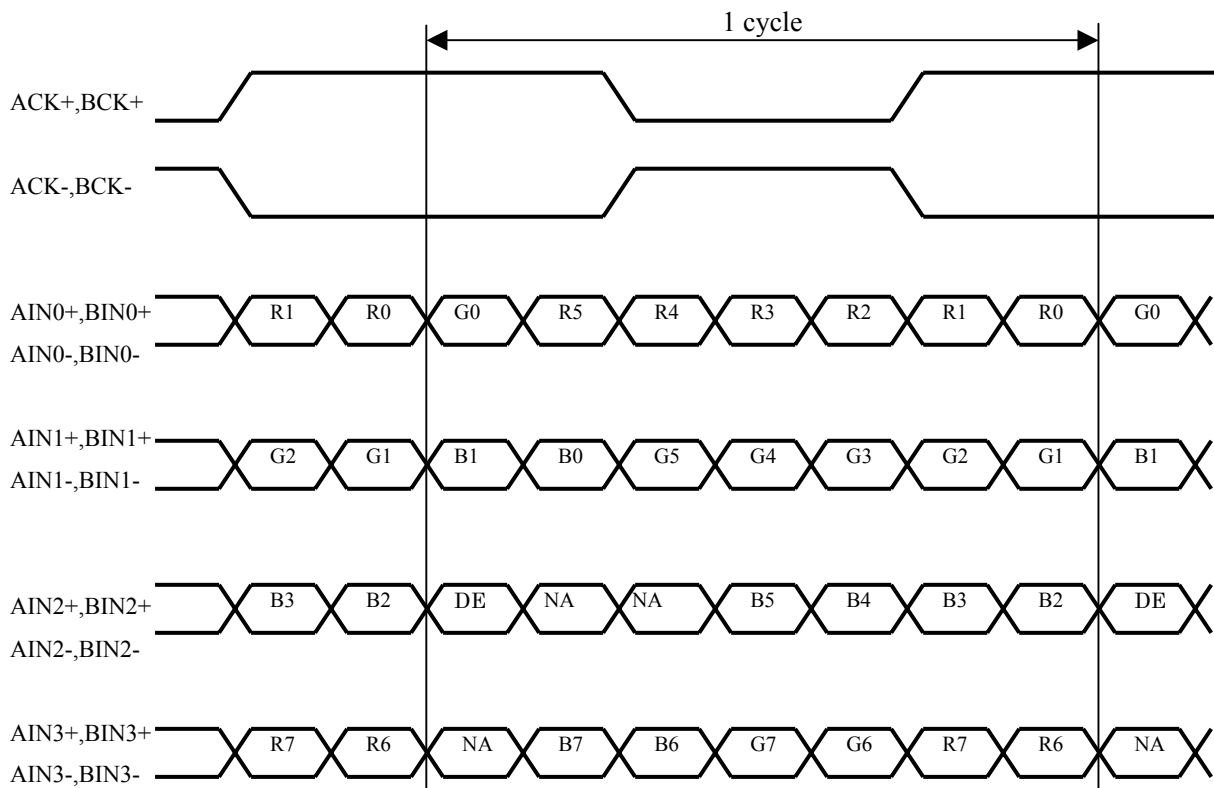

DE: Display Enable, NA: Not Available (Fixed Low)

CN2 (O/S control) (Shown Fig 1)

O/S Driving Pin No and function

Using connector : SM07B-SRSS-TB-A (JST)

www.DataSheet4U.com

Mating connector : SHR-07V-S or SHR-07V-S-B (JST)

Pin No.	Symbol	Function	Default	Remark
1	FRAME	Frame frequency setting 1:60Hz 0:50Hz	Pull down :GND	
2	O/S set	O/S operation setting H:O/S_ON, L:O/S_OFF [Note 1]	Pull up 3.3V	[Note 2]
3	TEST	Not Available	Pull down :GND	
4	Temp3	Data3 of panel surface temperature	Pull up 3.3V	[Note 2]
5	Temp2	Data2 of panel surface temperature	Pull up 3.3V	[Note 2]
6	Temp1	Data1 of panel surface temperature	Pull up 3.3V	[Note 2]
7	GND	GND		

*L: Low level voltage (GND) H: High level voltage(3.3V)

[Note 1] In case of O/S set setting "L"(O/S_OFF), it should be set the TEMP1~3 to "L".

[Note 2] The equivalent circuit figure of the terminal

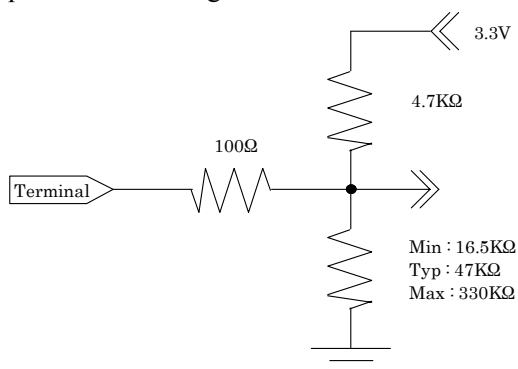

According as the surface temperature of the panel, enter the optimum 3 bit signal into pin No.4, 5 and 6. Measuring the correlation between detected temperature by the sensor on PWB in user's side and actual surface temperature of panel at center, convert the temperature detected by the sensor to the surface temperature of panel to enter the 3 bit temperature data.

For overlapping temperatures (such as 5°C, 10°C, 15°C, 20°C, 25°C, 30°C, 35°C) select the optimum parameter, judging from the actual picture image.

Pin no.	Surface temperature of panel							
	0-5°C	5-10°C	10-15°C	15-20°C	20-25°C	25-30°C	30-35°C	35°C and above
4	0	0	0	0	1	1	1	1
5	0	0	1	1	0	0	1	1
6	0	1	0	1	0	1	0	1

*0: Low level voltage (GND) 1: High level voltage(3.3V)

*For overlapping temperatures (such as 5°C, 10°C, 15°C, 20°C, 25°C, 30°C, 35°C) select the optimum parameter, judging from the actual picture image.

4.2. Interface block diagram

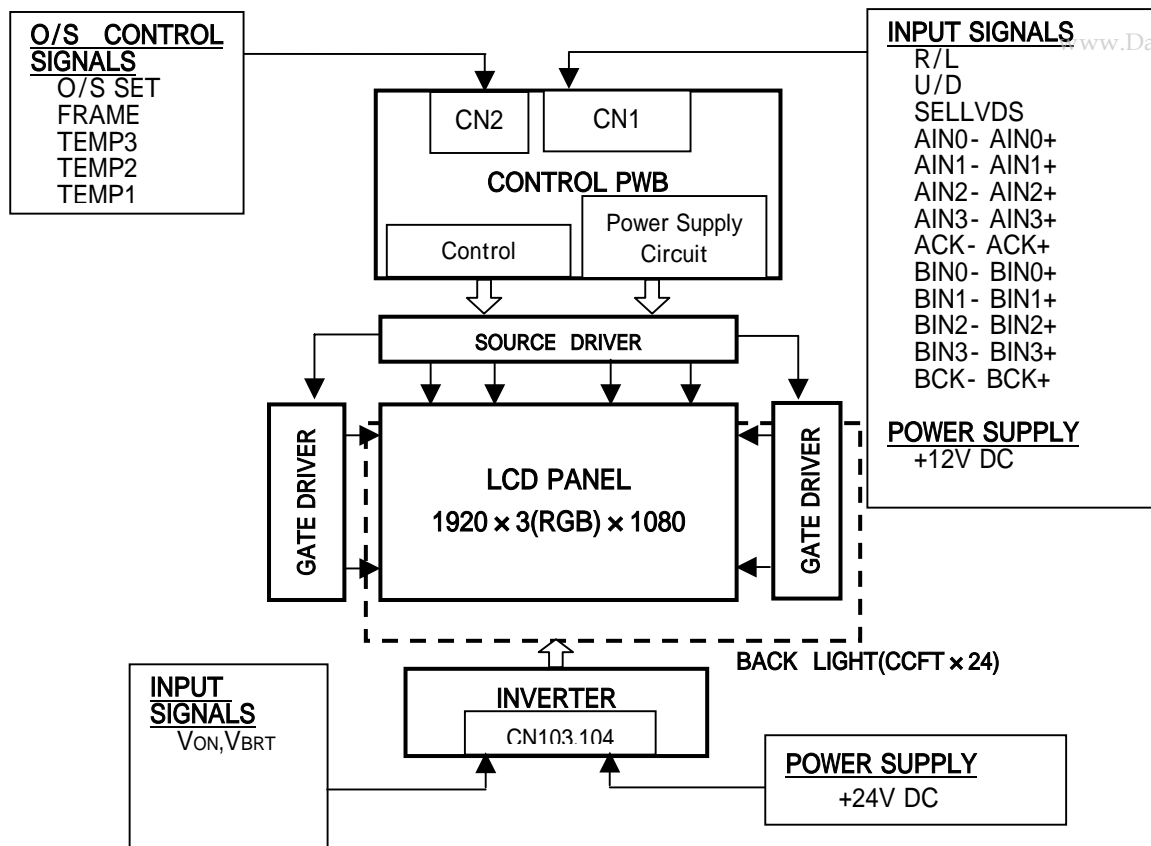

4.3. Backlight driving

CN103 (+24V DC power supply and inverter control)

www.DataSheet4U.com

Using connector: S14B-PH-K-S (LF) (JST)

Mating connector: PHR-14 (JST)

Pin No.	Symbol	Function	Default(OPEN)	Input Impedance	Remark
1	V _{INV}	+24V	-		
2	V _{INV}	+24V	-		
3	V _{INV}	+24V	-		
4	V _{INV}	+24V	-		
5	V _{INV}	+24V	-		
6	GND		-		
7	GND		-		
8	GND		-		
9	GND		-		
10	GND		-		
11	Reserved	For LCD module internal usage, should be open			
12	V _{ON}	Inverter ON/OFF	GND : pull down Inverter OFF	22K ohm	[Note 1]
13	V _{BRT}	Brightness Control	3.3V : pull up Brightness 100%	950K ohm	[Note 2]
14	Reserved	For LCD module internal usage, should be open			

*GND of an inverter board is not connected to GND of a module chassis and a liquid crystal panel drive part.

CN104(+24V DC power supply)

Using connector: S14B-PH-K-S(LF) (JST)

Mating connector: PHR-12 (JST)

Pin No.	Symbol	Function	Default(OPEN)	Input Impedance	Remark
1	V _{INV}	+24V	-		
2	V _{INV}	+24V	-		
3	V _{INV}	+24V	-		
4	V _{INV}	+24V	-		
5	V _{INV}	+24V	-		
6	GND		-		
7	GND		-		
8	GND		-		
9	GND		-		
10	GND		-		
11	Reserved	For LCD module internal usage, should be open			
12	Reserved	For LCD module internal usage, should be open			
13	Reserved	For LCD module internal usage, should be open	-		
14	Reserved	For LCD module internal usage, should be open	-		

[Note 1] Inverter ON/OFF

Input voltage	Function
0V	Inverter : OFF
3.3V	Inverter : ON

[Note 2]Brightness Control

PWM brightness control is regulated by analog input voltage (0V to 3.3V).

	MIN	TYP	MAX	Function
Input voltage [V]	0	<->	3.3	0V: Dark - 3.3V: Bright
[Reference] Brightness ratio [%]	20	<->	100	

[Note] PWM frequency : 275±10Hz

[Note]There is a case that lamp mura may happen, depending on ambient temperature and dimming.

Dimming level should be set according to your evaluation of actual display performance.

(Minimum input voltage 1.4V at below 15)

4.4. The back light system characteristics

The back light system is direct type with 24 CCFTs (Cold Cathode Fluorescent Tube).

The characteristics of the lamp are shown in the following table. The value mentioned below is at the case of one CCFT.

Item	Symbol	Min.	Typ.	Max.	Unit	Remarks
Life time	T _L	-	60000	-	Hour	[Note]

[Note]

- Lamp life time is defined as the time when brightness becomes 50% of the original value in the continuous operation under the condition of Ta=25°C and brightness control(V_{BRT}=100%).
- Above value is applicable when the long side of LCD module is placed horizontally (Landscape position).
(Lamp lifetime may vary if LCD module is in portrait position due to the change of mercury density inside the lamp.)

5. Absolute Maximum Ratings

Parameter	Symbol	Condition	Ratings	Unit	Remark
Input voltage (for Control)	V _I	Ta=25 °C	-0.3 ~ 3.6	V	[Note 1]
12V supply voltage (for Control)	V _{CC}	Ta=25 °C	0 ~ + 14	V	
Input voltage (for Inverter)	V _{ON} V _{BRT}	Ta=25 °C	0 ~ + 6	V	
24V supply voltage (for Inverter)	V _{INV}	Ta=25 °C	0 ~ +29	V	
Storage temperature	T _{stg}	-	-25 ~ +60	°C	[Note 2]
Operation temperature (Ambient)	T _{opa}	-	0 ~ +50	°C	

[Note 1] SELVDS, R/L, U/D, FRAME, O/S_set, TEMP1~3

[Note 2] Humidity 95%RH Max.(Ta 40°C)

Maximum wet-bulb temperature at 39 °C or less.(Ta>40°C)

No condensation.

6. Electrical Characteristics

6.1. Control circuit driving

Ta=25 °C

Parameter	Symbol	Min.	Typ.	Max.	Unit	Remark	
+12V supply voltage	Supply voltage	V _{CC}	11.4	12	12.6	V [Note 1]	
	Current dissipation	I _{CC}	-	0.8	1.6	A [Note 2]	
	Inrush current	I _{RUSH}	-	2.0	-	A	[Note 7]
T _{RUSH}		-	0.1	-	ms		
Permissible input ripple voltage	V _{RP}	-	-	100	mV _{P-P}	V _{CC} = +12.0V	
Differential input threshold voltage	High	V _{TH}	-	-	100	mV	V _{CM} = +1.2V [Note 6]
	Low	V _{TL}	-100	-	-	mV	
Input Low voltage	V _{IL}	0	-	1.0	V	[Note 3]	
Input High voltage	V _{IH}	2.3	-	3.3	V		
Input leak current (Low)	I _{IL1}	-	-	400	μA	V _I = 0V [Note 4]	
	I _{IL2}	-	-	40	μA	V _I = 0V [Note 5]	
Input leak current (High)	I _{IH1}	-	-	40	μA	V _I = 3.3V [Note 4]	
	I _{IH2}	-	-	400	μA	V _I = 3.3V [Note 5]	
Terminal resistor	R _T	-	100	-	Ω	Differential input	

[Note] V_{CM}: Common mode voltage of LVDS driver.

[Note 1]

Input voltage sequences

- 0 < t1 20ms
- 10 < t2 20ms
- 10 < t3 50ms
- 0 < t4 1s
- t5 200ms
- t6 0
- t7 300ms

Dip conditions for supply voltage

- a) 6.5V V_{CC} < 10.8V
- td 10ms
- b) V_{CC} < 6.5V

Dip conditions for supply voltage is based on input voltage sequence.

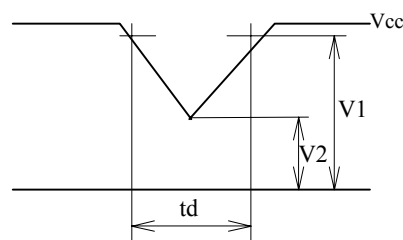
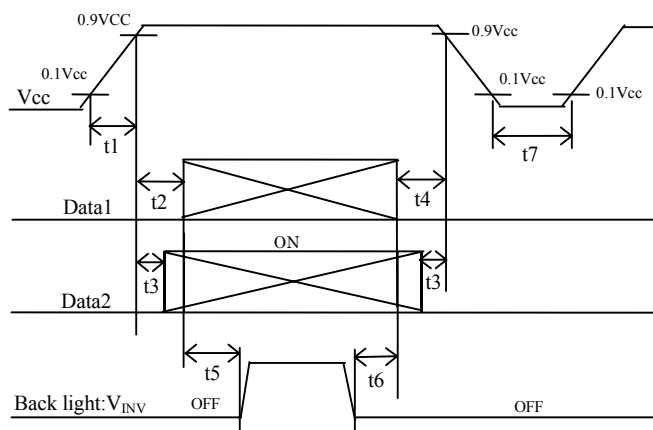

V1: 10.8V
V2: 6.5V

Data1: ACK±, AIN0±, AIN1±, AIN2±, AIN3±, BCK±, BIN0±, BIN1±, BIN2±, BIN3±

*V_{CM} voltage pursues the sequence mentioned above

Data2: R/L, U/D, SELLVDS, FRAME, O/S_SET, TEMP1, TEMP2, TEMP3

[Note] About the relation between data input and back light lighting, please base on the above-mentioned input sequence. When back light is switched on before panel operation or after a panel operation stop, it may not display normally. But this phenomenon is not based on change of an incoming signal, and does not give damage to a liquid crystal display.

[Note 2] Typical current situation: 255 gray-bar patterns. (Vcc = +12.0V)

The explanation of RGB gray scale is seen in section 8.

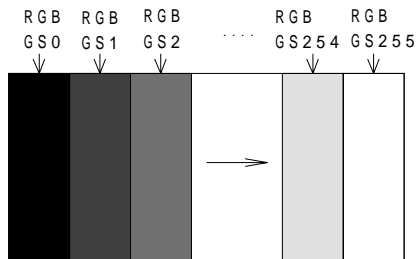

Vcc = +12.0V
 CK = 74.25MHz
 Th = 14.8µs

[Note 3] R/L, U/D, SELLVDS, FRAME, O/S_SET, TEMP1, TEMP2, TEMP3

[Note 4] SELLVDS, O/S_SET, TEMP1, TEMP2, TEMP3

[Note 5] R/L, U/D, FRAME

[Note 6] ACK±, AIN0±, AIN1±, AIN2±, AIN3±, BCK±, BIN0±, BIN1±, BIN2±, BIN3±

[Note 7] Vcc12V inrush current waveform

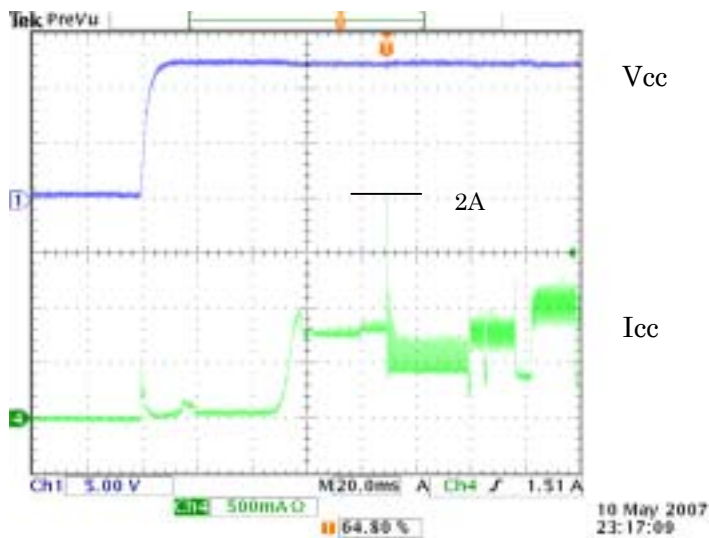

6.2. Inverter driving for back light

The back light system is direct type with 24 CCFTs (Cold Cathode Fluorescent Tube).

Parameter	Symbol	Min.	Typ.	Max.	Unit	Remark	
+ 24V	Current dissipation 1	I _{INV 1}	-	11.2	12.5	A	V _{INV} = 24V, Ta=25°C V _{BRT} = 3.3V [Note 1,2]
	Current dissipation 2	I _{INV 2}	-	10.3	11.5	A	
	Supply voltage	V _{INV}	22.8	24.0	25.2	V	
Permissible input ripple voltage	V _{RF}	-	-	300	mV _{p-p}	V _{INV} = +24.0V	
Input voltage (Low)	V _{ONL}	0	-	1.0	V	V _{ON} , V _{BRT}	
Input voltage (High)	V _{ONH}	2.3	-	3.6	V		

[Note 1] 1) V_{INV}-turn-on condition

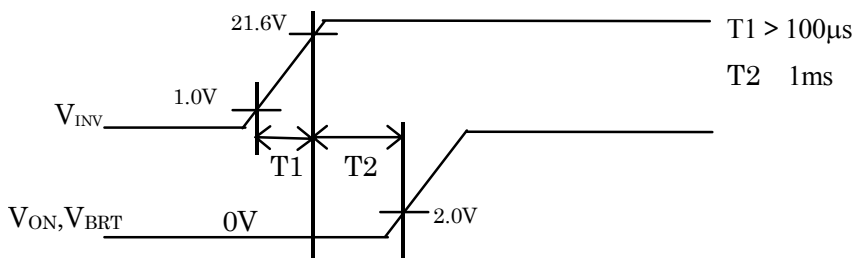

2) V_{INV}-turn-off condition

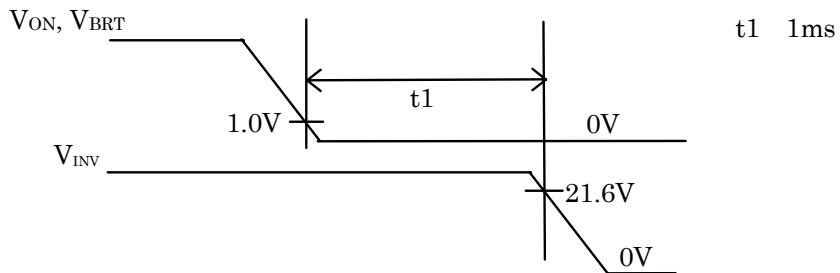

[Note 2] Current dissipation 1 : Definition within 60 minutes after turn on. (Rush current is excluded.)
Current dissipation 2 : Definition more than 60minutes after turn on.

7. Timing characteristics of input signals

7.1. Timing characteristics

www.DataSheet4U.com

Timing diagrams of input signal are shown in Fig.2.

Parameter		Symbol	Min.	Typ.	Max.	Unit	Remark
Clock	Frequency	1/Tc	55	74.25	85	MHz	
Data enable signal	Horizontal period	TH	984	1100	1650	clock	
			12.0	14.8	-	μs	
	Horizontal period (High)	THd	960	960	960	clock	
	Vertical period	TV	1109	1125	1350	line	
	Vertical period (High)	TVd	1080	1080	1080	line	

[Note]-When vertical period is very long, flicker and etc. may occur.

- Please turn off the module after it shows the black screen.
- Please make sure that length of vertical period should become of an integral multiple of horizontal length of period. Otherwise, the screen may not display properly.
- As for your final setting of driving timing, we will conduct operation check test at our side, please inform your final setting.

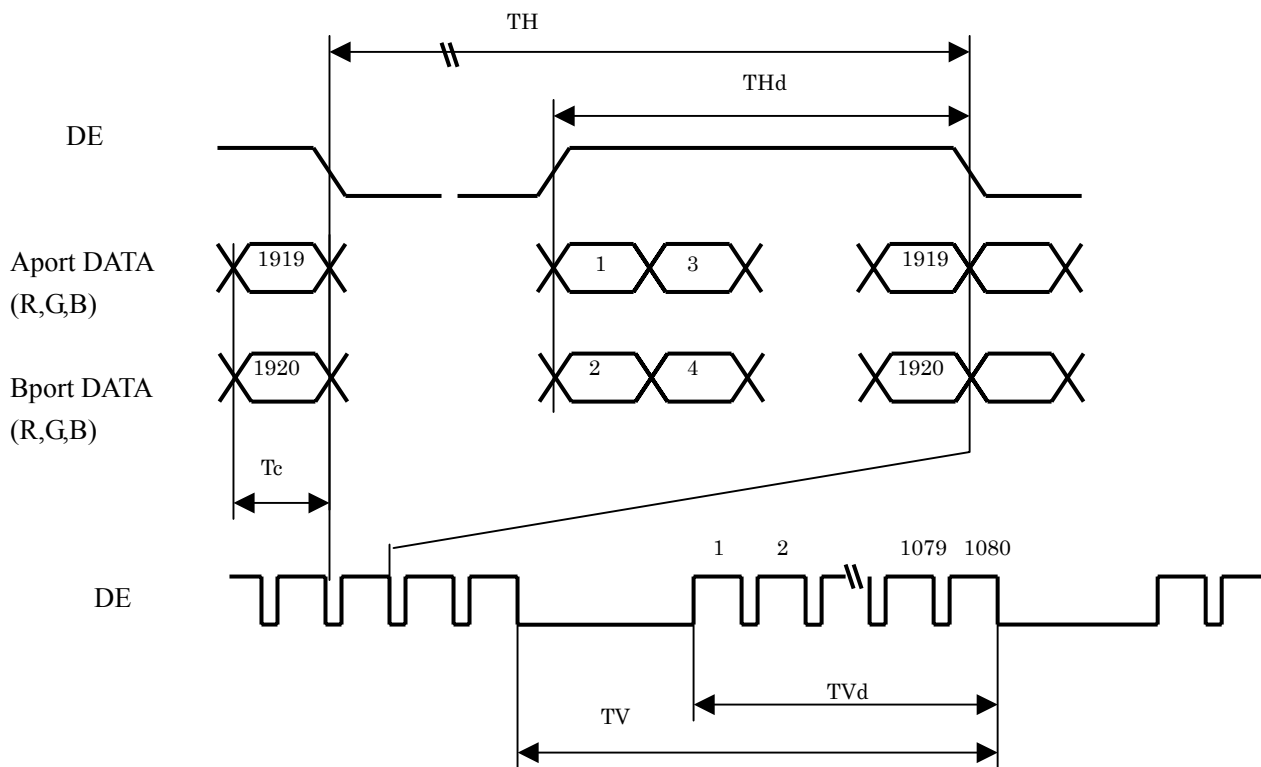
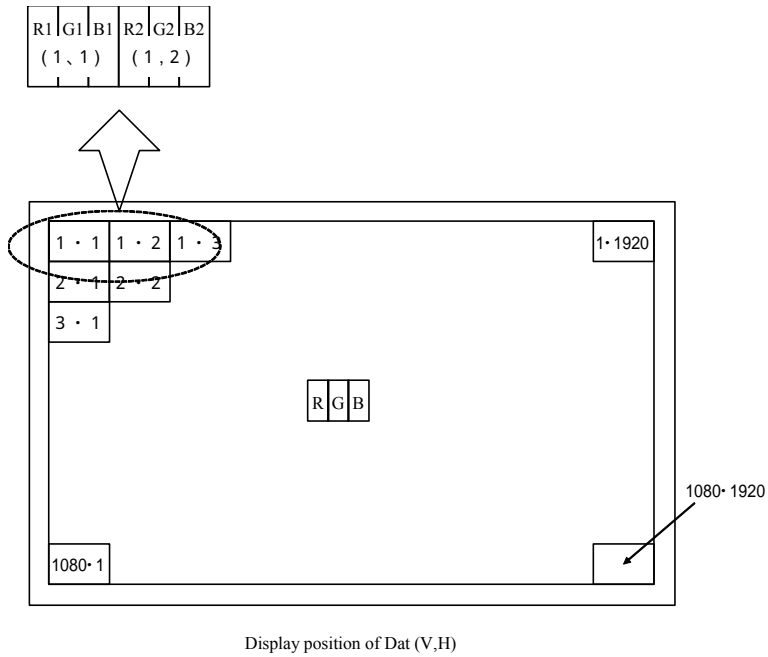

Fig.2 Timing characteristics of input signals

7.2. Input data signal and display position on the screen



8. Input Signal, Basic Display Colors and Gray Scale of Each Color

Colors & Gray scale	Data signal																								
	Gray Scale	R0	R1	R2	R3	R4	R5	R6	R7	G0	G1	G2	G3	G4	G5	G6	G7	B0	B1	B2	B3	B4	B5	B6	B7
Basic Color	Black	-	0	0	0	0	0	0	0	0	0	0	0	0	0	0	0	0	0	0	0	0	0	0	
	Blue	-	0	0	0	0	0	0	0	0	0	0	0	0	0	0	0	1	1	1	1	1	1	1	1
	Green	-	0	0	0	0	0	0	0	0	1	1	1	1	1	1	1	0	0	0	0	0	0	0	0
	Cyan	-	0	0	0	0	0	0	0	0	1	1	1	1	1	1	1	1	1	1	1	1	1	1	1
	Red	-	1	1	1	1	1	1	1	1	0	0	0	0	0	0	0	0	0	0	0	0	0	0	0
	Magenta	-	1	1	1	1	1	1	1	1	0	0	0	0	0	0	0	1	1	1	1	1	1	1	1
	Yellow	-	1	1	1	1	1	1	1	1	1	1	1	1	1	1	1	0	0	0	0	0	0	0	0
	White	-	1	1	1	1	1	1	1	1	1	1	1	1	1	1	1	1	1	1	1	1	1	1	1
Gray Scale of Red	Black	GS0	0	0	0	0	0	0	0	0	0	0	0	0	0	0	0	0	0	0	0	0	0	0	
	↑	GS1	1	0	0	0	0	0	0	0	0	0	0	0	0	0	0	0	0	0	0	0	0	0	
	Darker	GS2	0	1	0	0	0	0	0	0	0	0	0	0	0	0	0	0	0	0	0	0	0	0	
	↑	↓				↓							↓								↓				
	↓	↓				↓							↓								↓				
	Brighter	GS253	1	0	1	1	1	1	1	1	0	0	0	0	0	0	0	0	0	0	0	0	0	0	
	↓	GS254	0	1	1	1	1	1	1	1	0	0	0	0	0	0	0	0	0	0	0	0	0	0	
	Red	GS255	1	1	1	1	1	1	1	1	0	0	0	0	0	0	0	0	0	0	0	0	0	0	
Gray Scale of Green	Black	GS0	0	0	0	0	0	0	0	0	0	0	0	0	0	0	0	0	0	0	0	0	0	0	
	↑	GS1	0	0	0	0	0	0	0	0	1	0	0	0	0	0	0	0	0	0	0	0	0	0	
	Darker	GS2	0	0	0	0	0	0	0	0	0	1	0	0	0	0	0	0	0	0	0	0	0	0	
	↑	↓				↓							↓								↓				
	↓	↓				↓							↓								↓				
	Brighter	GS253	0	0	0	0	0	0	0	0	1	0	1	1	1	1	1	1	1	1	0	0	0	0	
	↓	GS254	0	0	0	0	0	0	0	0	0	1	1	1	1	1	1	1	1	1	0	0	0	0	
	Green	GS255	0	0	0	0	0	0	0	0	1	1	1	1	1	1	1	1	1	1	0	0	0	0	
Gray Scale of Blue	Black	GS0	0	0	0	0	0	0	0	0	0	0	0	0	0	0	0	0	0	0	0	0	0	0	
	↑	GS1	0	0	0	0	0	0	0	0	0	0	0	0	0	0	0	1	0	0	0	0	0	0	
	Darker	GS2	0	0	0	0	0	0	0	0	0	0	0	0	0	0	0	0	1	0	0	0	0	0	
	↑	↓				↓							↓								↓				
	↓	↓				↓							↓								↓				
	Brighter	GS253	0	0	0	0	0	0	0	0	0	0	0	0	0	0	0	1	0	1	1	1	1	1	
	↓	GS254	0	0	0	0	0	0	0	0	0	0	0	0	0	0	0	0	1	1	1	1	1	1	
	Blue	GS255	0	0	0	0	0	0	0	0	0	0	0	0	0	0	0	1	1	1	1	1	1	1	

0 : Low level voltage, 1 : High level voltage.

Each basic color can be displayed in 256 gray scales from 8 bit data signals. According to the combination of total 24 bit data signals, the 16-million-color display can be achieved on the screen.

9. Optical characteristics

Ta=25°C, Vcc=12.0V, VINV =24.0V, VBRT=3.3V Timing:60Hz(typ. value)

Parameter		Symbol	Condition	Min.	Typ.	Max.	Unit	Remark
Viewing angle range	Horizontal	θ_{21} θ_{22}	CR 10	70	88	-	Deg.	[Note1,4]
	Vertical	θ_{11} θ_{12}		70	88	-	Deg.	
Contrast ratio		CRn	$\theta=0$ deg.	1000	1500	-		[Note2,4]
Response time		τ_r τ_d		-	6	-	ms	[Note3,4,5]
Chromaticity	White	x		0.242	0.272	0.302	-	[Note4]
		y		0.247	0.277	0.307	-	
	Red	x		0.610	0.640	0.670	-	
		y		0.300	0.330	0.360	-	
	Green	x		0.250	0.280	0.310	-	
		y		0.570	0.600	0.630	-	
	Blue	x		0.120	0.150	0.180	-	
		y		0.030	0.060	0.090	-	
Gamma		-	-	2.2	-	-		
Luminance	White	Y_L	360	450	-	cd/m ²		
Luminance uniformity	White	δw	-	-	1.25	-	[Note 6]	

Measurement condition: Set the value of VBRT to maximum luminance of white.

*The measurement shall be executed 60 minutes after lighting at rating.

[Note]The optical characteristics are measured using the following equipment.

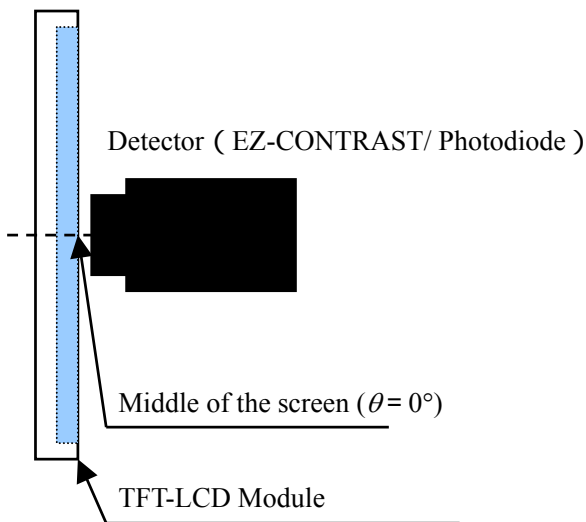

Fig.4-1 Measurement of viewing angle range and Response time.
Viewing angle range: EZ-CONTRAST
Response time: Photodiode

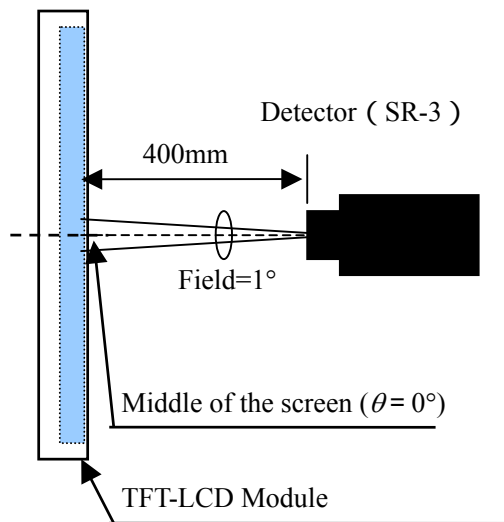
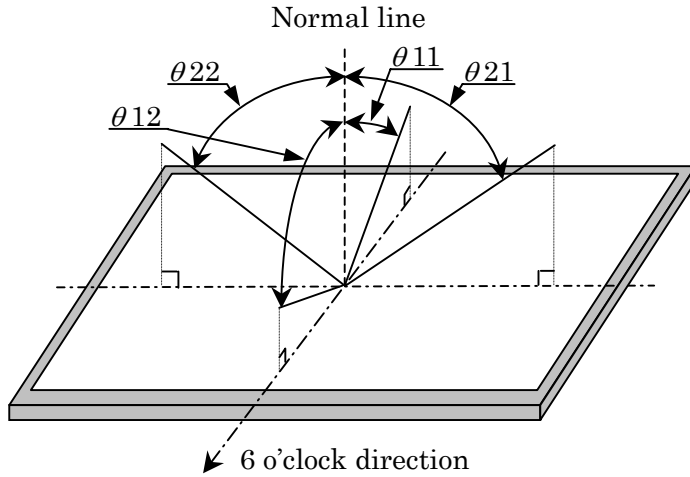

Fig.4-2 Measurement of Contrast, Luminance, Chromaticity.

[Note 1]Definitions of viewing angle range :



www.DataSheet4U.com

[Note 2]Definition of contrast ratio :

The contrast ratio is defined as the following.

$$\text{Contrast Ratio} = \frac{\text{Luminance (brightness) with all pixels white}}{\text{Luminance (brightness) with all pixels black}}$$

[Note 3]Definition of response time

The response time (τ_d and τ_r) is defined as the following figure and shall be measured by switching the input signal for “any level of gray (0%, 25%, 50%, 75% and 100%)” and “any level of gray (0%, 25%, 50%, 75% and 100%)”.

	0%	25%	50%	75%	100%
0%		tr:0%-25%	tr:0%-50%	tr:0%-75%	tr:0%-100%
25%	td: 25%-0%		tr: 25%-50%	tr:25%-75%	tr: 25%-100%
50%	td: 50%-0%	td: 50%-25%		tr: 50%-75%	tr: 50%-100%
75%	td: 75%-0%	td: 75%-25%	td: 75%-50%		tr: 75%-100%
100%	td: 100%-0%	td: 100%-25%	td: 100%-50%	td:100%-75%	

t*:x-y...response time from level of gray(x) to level of gray(y)

$$\tau_r = \Sigma(\text{tr}:x-y)/10, \tau_d = \Sigma(\text{td}:x-y)/10$$

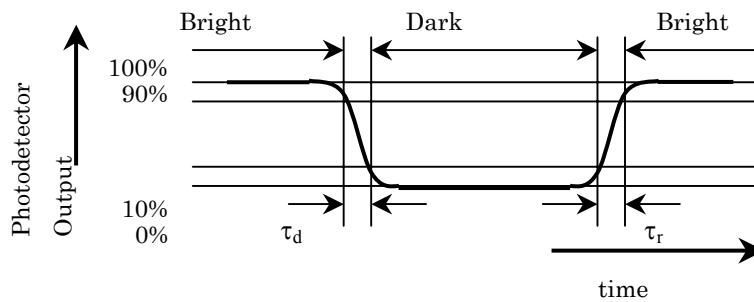

[Note 4]This shall be measured at center of the screen.

[Note 5] This value is valid when O/S driving is used at typical input time value.

[Note 6]Definition of white uniformity ;

White uniformity is defined as the following with five measurements. (A~E)

$$\delta_w = \frac{\text{Maximum luminance of five points (brightness)}}{\text{Minimum luminance of five points (brightness)}}$$

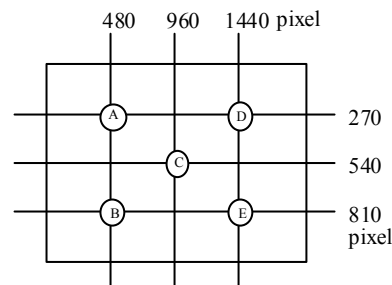

10. Handling Precautions of the module

- a) Be sure to turn off the power supply when inserting or disconnecting the cable.
- b) This product is using the parts (inverter, CCFT etc), which generate the high voltage.

Therefore, during operating, please don't touch these parts.

- c) Brightness control voltage is switched for “ON” and “OFF”, as shown in Fig.4. Voltage difference generated by this switching, ΔV_{INV} , may affect a sound output, etc. when the power supply is shared between the inverter and its surrounding circuit. So, separate the power supply of the inverter circuit with the one of its surrounding circuit.

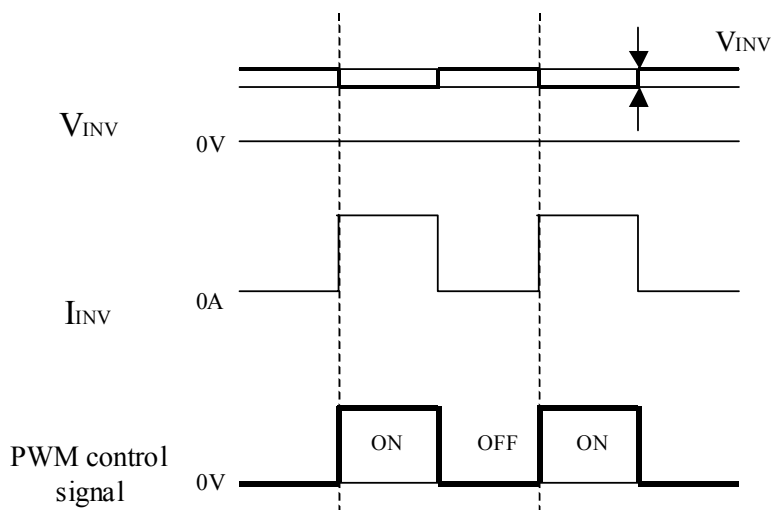

Fig.4 Brightness control voltage.

*Since inverter board's GND is not connected to the frame of the LCD module, please connect it with the Customer's GND of inverter power supply.

- d) Be sure to design the cabinet so that the module can be installed without any extra stress such as warp or twist.
- e) Since the front polarizer is easily damaged, pay attention not to scratch it.
- f) Since long contact with water may cause discoloration or spots, wipe off water drop immediately.
- g) When the panel surface is soiled, wipe it with absorbent cotton or other soft cloth.
- h) Since the panel is made of glass, it may break or crack if dropped or bumped on hard surface. Handle with care.

- i) Since CMOS LSI is used in this module, take care of static electricity and take the human earth into consideration when handling.
- j) The module has some printed circuit boards (PCBs) on the back side, take care to keep them from any stress or pressure when handling or installing the module; otherwise some of electronic parts on the PCBs may be damaged.
- k) Observe all other precautionary requirements in handling components.
- l) When some pressure is added onto the module from rear side constantly, it causes display non-uniformity issue, functional defect, etc. So, please avoid such design.
- m) When giving a touch to the panel at power on supply, it may cause some kinds of degradation. In that case, once turn off the power supply, and turn on after several seconds again, and that is disappear.
- n) When handling LCD modules and assembling them into cabinets, please be noted that long-term storage in the environment of oxidization or deoxidization gas and the use of such materials as reagent, solvent, adhesive, resin, etc. which generate these gasses, may cause corrosion and discoloration of the LCD modules.
- o) This LCD module is designed to prevent dust from entering into it. However, there would be a possibility to have a bad effect on display performance in case of having dust inside of LCD module. Therefore, please ensure to design your TV set to keep dust away around LCD module.

11. Packing form

- a) Piling number of cartons: 2 maximum
- b) Packing quantity in one carton: 8 pcs.
- c) Carton size: 1320 (W) × 1110 (D) × 940 (H) (mm)
- d) Total mass of one carton filled with full modules: 225kg (Max)

12. Reliability test item

No.	Test item	Condition
1	High temperature storage test	Ta=60°C 240h
2	Low temperature storage test	Ta=-25°C 240h
3	High temperature and high humidity operation test	Ta=40°C ; 95%RH 240h (No condensation)
4	High temperature operation test	Ta=50°C 240h
5	Low temperature operation test	Ta=0°C 240h
6	Vibration test (non-operation)	Frequency: 10~57Hz/Vibration width (one side): 0.075mm : 58~500Hz/Acceleration: 9.8 m/s ² Sweep time: 11 minutes Test period: 3 hours (1h for each direction of X, Y, Z)
7	Shock test (non-operation)	Maximum acceleration: 294m/s ² Pulse width: 11ms, sinusoidal half wave Direction: +/-X, +/-Y, +/-Z, once for each direction.
8	ESD	* At the following conditions, it is a thing without incorrect operation and destruction. (1)Non-operation: Contact electric discharge ±10kV Non-contact electric discharge ±20kV (2)Operation Contact electric discharge ±8kV Non-contact electric discharge ±15kV Conditions: 150pF, 330ohm

[Result evaluation criteria]

Under the display quality test condition with normal operation state, there shall be no change, which may affect practical display function.

13. Others

1) Lot No. Label ;

The label that displays SHARP, product model (LK520D3LZ18), a product number is stuck on the back of the module.

www.DataSheet4U.com

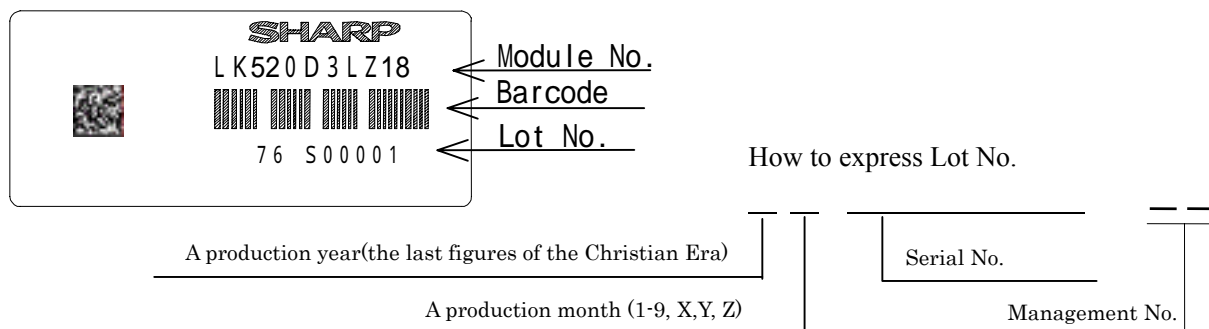

2) Packing Label

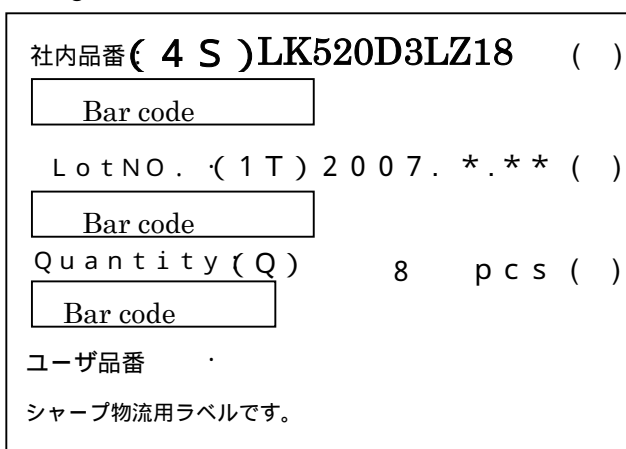

Management No. (LK520D3LZ18)

Lot No. (Date)

Quantity

3) Adjusting volume has been set optimally before shipment, so do not change any adjusted value.

If adjusted value is changed, the specification may not be satisfied.

4) Disassembling the module can cause permanent damage and should be strictly avoided.

5) Please be careful since image retention may occur when a fixed pattern is displayed for a long time.

6) The chemical compound, which causes the destruction of ozone layer, is not being used.

7) Cold cathode fluorescent lamp in LCD PANEL contains a small amount of mercury. Please follow local ordinances or regulations for disposal. This sentence is displayed on the backside of the module.

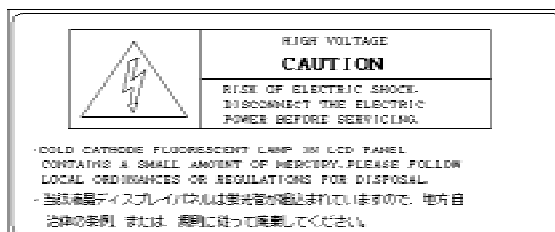

8) When any question or issue occurs, it shall be solved by mutual discussion.

9) This module is corresponded to RoHS.

14. Carton storage condition

Temperature	0°C to 40°C
Humidity	95%RH or less
Reference condition	: 20°C to 35°C, 85%RH or less (summer) : 5°C to 15°C, 85%RH or less (winter) • the total storage time (40°C,95%RH) : 240H or less
Sunlight	Be sure to shelter a product from the direct sunlight.
Atmosphere	Harmful gas, such as acid and alkali which bites electronic components and/or wires must not be detected.
Notes	Be sure to put cartons on palette or base, don't put it on floor, and store them with removing from wall Please take care of ventilation in storehouse and around cartons, and control changing temperature is within limits of natural environment
Storage life	1 year

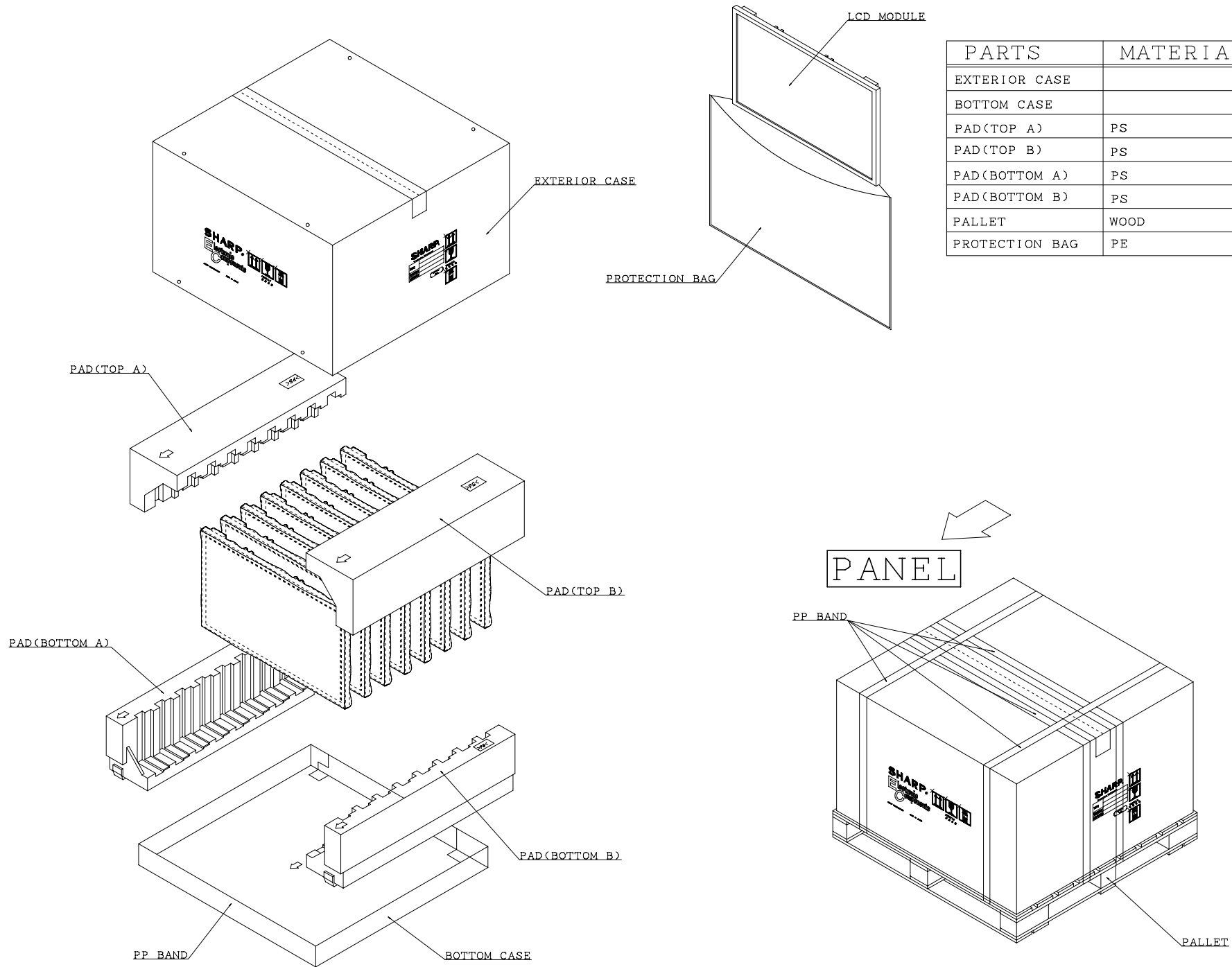

PARTS	MATERIAL	REMARKS
EXTERIOR CASE		-
BOTTOM CASE		-
PAD(TOP A)	PS	-
PAD(TOP B)	PS	-
PAD(BOTTOM A)	PS	-
PAD(BOTTOM B)	PS	-
PALLET	WOOD	-
PROTECTION BAG	PE	-

Fig. 2 Packing Form

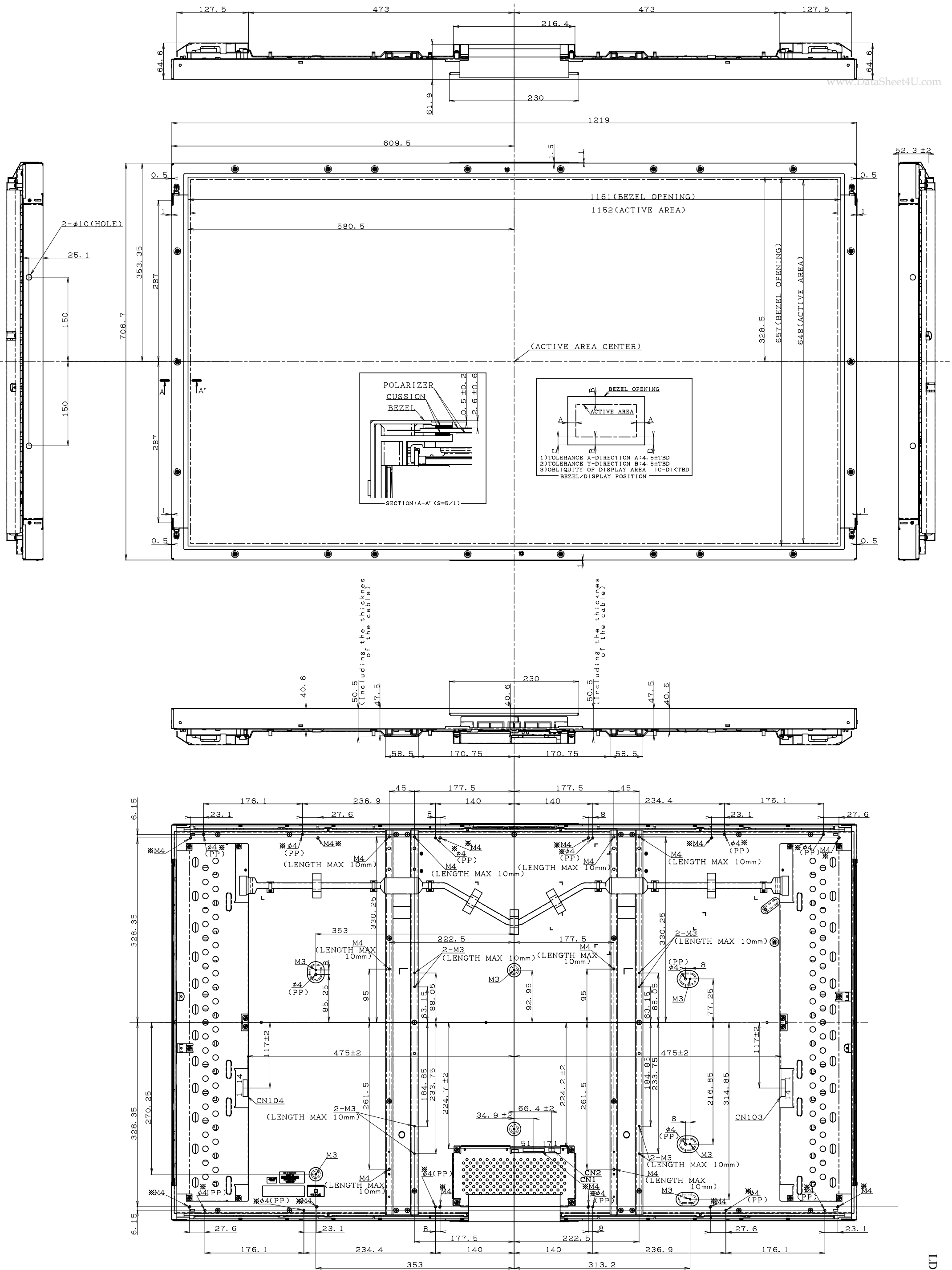

Fig.1 LK520D3LZ18 □
OUTLINE DIMENSIONS

NOTE)
 1. UNSPECIFIED TOLERANCE TO BE ±1.7
 2. RIGHT AND LEFT SIDEPIECE IS SYMMETRIC SHAPE
 * PP:A POSITIONING PROJECTION