

JPS250 Series Application Note

Contents:

1. Introduction
2. Safety Agency Approvals
3. Emission Standards
4. Input Specifications
5. Output Specifications
6. General Specifications
7. Environmental Specifications
8. Mechanical Specifications
9. Control & Supervisory Signals
10. Characteristic Curves
11. Part Numbering (Options)
12. Warranty Statement

Section 1: Introduction

The JPS250 Series Switching Power Supply is a single output switcher that utilizes Zero Voltage / Zero Current topology to allow efficient operation, small size and quiet operation. The Supplies offer 250 watt operation with 18 cfm airflow and 200 watt convection cooled operation.

Features Include:

- Ideal for 1U High / Low Profile Applications
- Active Power Factor Correction for EN61000-3-2 Compliance
- Greater than 80% Efficiencies
- World-Wide Safety Approvals
- Class B Emissions
- Full Featured Control and Status Signals

Section 2: Safety Agency Approvals

UL 1950.....	Approved
CSA 22.2 # 234.....	Approved
TUV EN60950.....	Approved
CE Mark.....	Filed

Section 3: Emission Standards

FCC.....	20780 Level B
CISPR.....	EN55022 Class B
EN61000-3-2.....	Pass
EN61000-4-2 level 4 (ESD Susceptibility).....	8 kv
EN61000-4-3 level 3 (Radiated Susceptibility).....	10 V/M
EN61000-4-4 level 3 (EFT / Burst).....	±2kv
EN61000-4-5 class 3 (Input Transient Protection).....	1 kV line to line 2 kV Line to Ground



Section 4: Input Specifications

VAC Input Range..... Universal Input (85-264 VAC)
 Input Frequency.....47-63Hz
 Turn on/off VACon @ 82 VAC / off @ 80 VAC
 Inrush Current.....30a @ 115 VAC / 60a @ 230 VAC max
 Nominal Input Current.....2.75a @ 115 VAC / 1.4a @ 230 VAC
 VDC Input Range.....170 370 VDC
 Hold-up Time.....20ms minimum
 Input Protection.....Single 5A Fuse
 Power Factor.....0.9 minimum
 Leakage Current.....<700uA

Section 5: Output Specifications

Output Power.....250 Watts
 Minimum Load Required.....n/a
 Line Regulation.....±0.5% maximum
 Load Regulation.....±1% maximum
 Set-Point Tolerance.....±1%
 Adjustment Range via trim pot.....±10%
 Ripple & Noise.....1% pk-pk maximum (20 mHz)
 Transient Response.....4% max deviation,
 <500 s recovery with 25% load change
 Over Voltage Protection.....115-140% of nominal, recycle AC
 Over Current Protection.....115-140% of nominal, auto recovery
 Over Temperature Protection.....standard

Model	Maximum Power ⁽¹⁾	Output Voltage	Output Currents:	
			with 18 CFM	Convection Cooled
JPS250PS05	225 W	5 V	45.0 A	36.0 A
JPS250PS12	250 W	12 V	21.0 A	17.0 A
JPS250PS15	250 W	15 V	17.0 A	13.5 A
JPS250PS24	250 W	24 V	10.4 A	8.5 A
JPS250PS48	250 W	48 V	5.2 A	4.3 A

Table 1: Output Voltages & Currents

Section 6: General Specifications

Efficiency.....>80% Typical (see characteristic curves)
 Power Density.....4.9w per in³
 MTBF.....>200,000 Hours per MILHDBK 217F
 Withstand Voltage.....3000 VAC Input to Output
 1500 VAC Input to Ground
 500 VAC Output to Ground

Model	Eff. %	Voltage	Current
JPS250PS05*	81.5 - 84.9	4.94-4.95	45 A*
JPS250PS12	82.6 - 85.1	11.973-11.976	21 A
JPS250PS15	83 - 85.5	14.856-14.862	17 A
JPS250PS24	83 - 87	23.977-23.977	10.4 A
JPS250PS48	83.6 - 87.4	47.915-47.904	5.2 A

* 225 Watts Maximum Power for 5v output model

Section 5: Environmental Specifications

Operating Temperature.....0-50°C
 De-Rating..... See De-Rating Curves (Table 3)
 Cooling.....18cfm for 250 W operation
Convection for 200 W Operation
 Storage Temperature.....-20 / +85°C
 Temperature Coefficient.....±0.05% / °C
 Humidity (non-condensing).....5-95%
 Altitude.....10,000 Feet Maximum for 250 Watt Operation

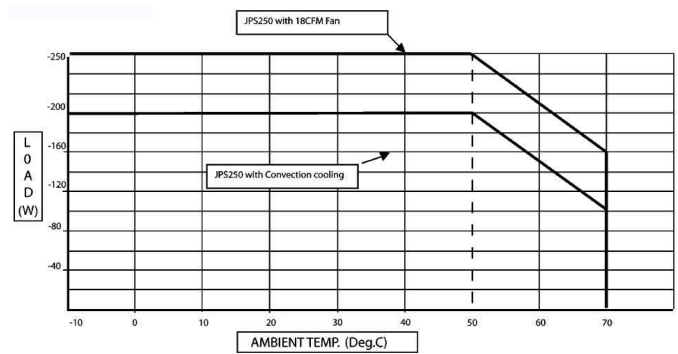

* De-Rate 5v output model 10%

Section 6: Mechanical Specification

DescriptionU-Frame Construction
 Size8 x 4.2 x 1.5" (203.2 x 106.7 x 38.1mm)
 Weight.....900g

Mechanical Drawing for all models other than JPS250PS05

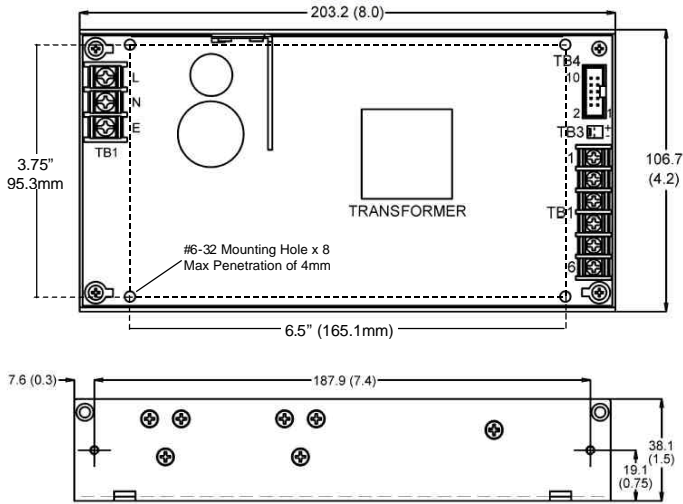

Mechanical Drawing for JPS250PS05
 (requires more terminals for output current)

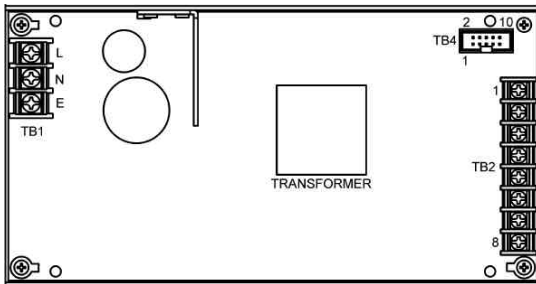

TB2 PIN Assignments: TB2 terminal block connections are for the output Voltage and current and are defined as follows:

TB2	1	2	3	4	5	6	7	8
JPS250PS05	+5V	+5V	GND	GND	GND	GND	+5V	+5V
JPS250PS12, 15, 24, 48	+V	+V	+V	GND	GND	GND	N/C	N/C

TB3 PIN Assignments: TB3 connection is for 12v @ 300ma fan output (not available on the JPS250PS05). Pin 1 is +12v, Pin 2 is Return. Mating Connector is Molex 5045-02A or equivalent.

TB4 Pin Assignments: TB4 connections are for Control and Supervisory Signals. Mating Connector is 70246-10

1	2	3	4	5	6	7	8	9	10
GND	DC OK	AC OK	Enable	+Sense	-Sense	Current Share	N/C	N/C	N/C

Section 7: Control & Supervisory Signals

AC OK.....TTL compatible, signal is High (5 V) = DC OK
 DC OK.....TTL compatible, signal is High (5 V) = DC OK
 Remote on/off.....Inhibit / TTL Low = ON, TTL High = OFF
 Remote Sense.....Compensates for up to 500mv drop
 Current Share (optional).....10% Accuracy

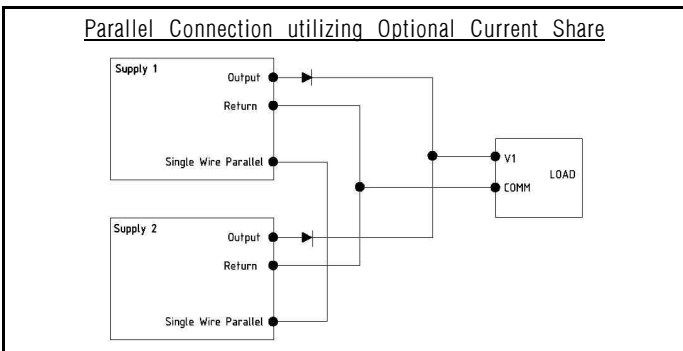
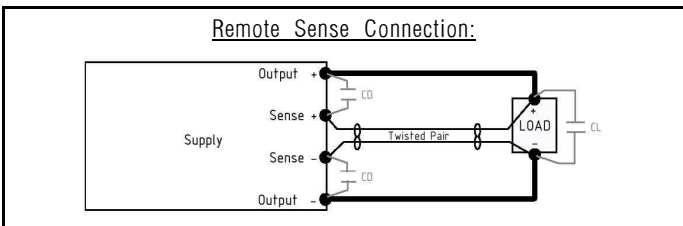
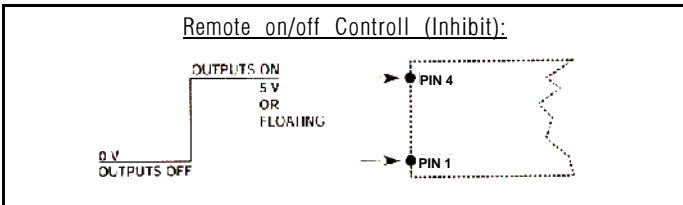
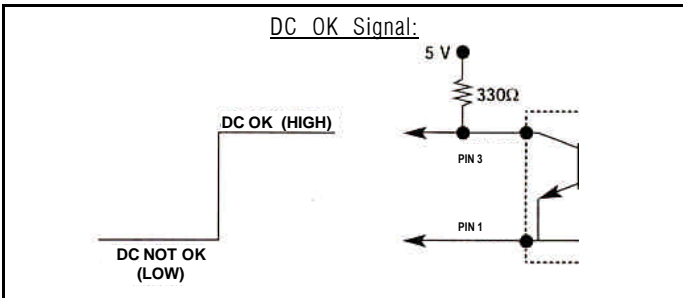
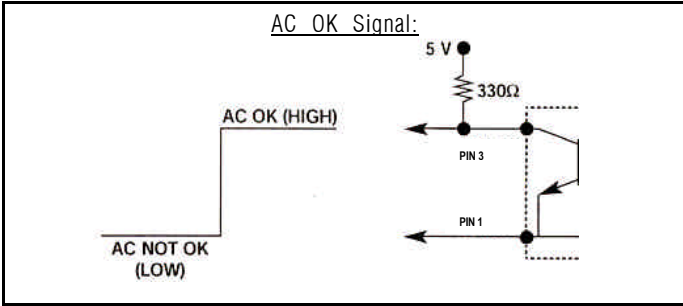

Section 10: Characteristic Curves JPS250PS05

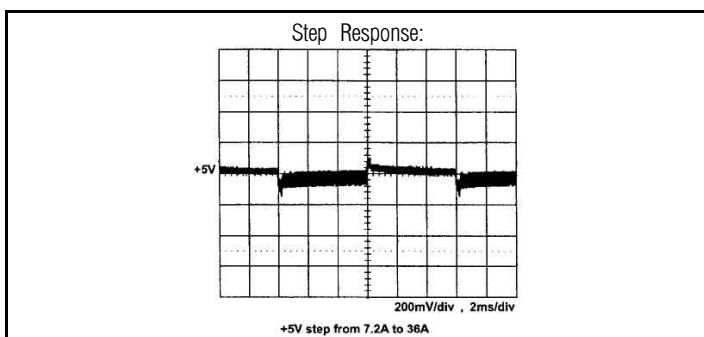
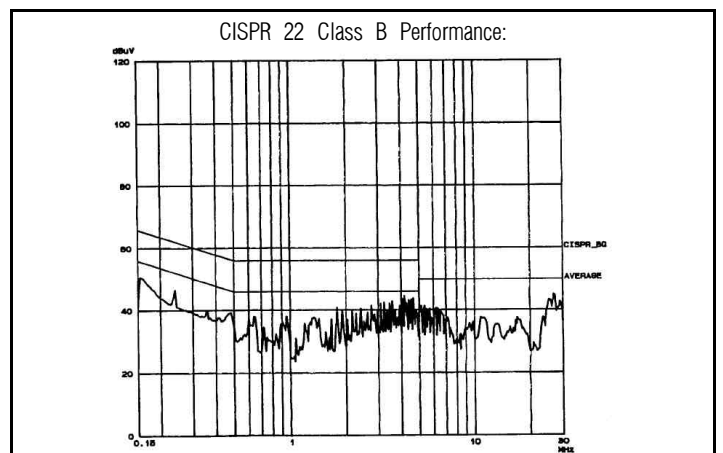
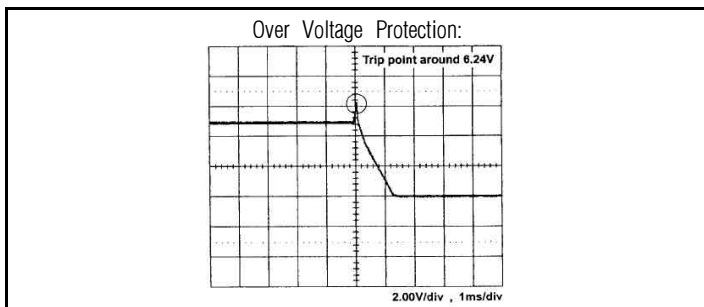
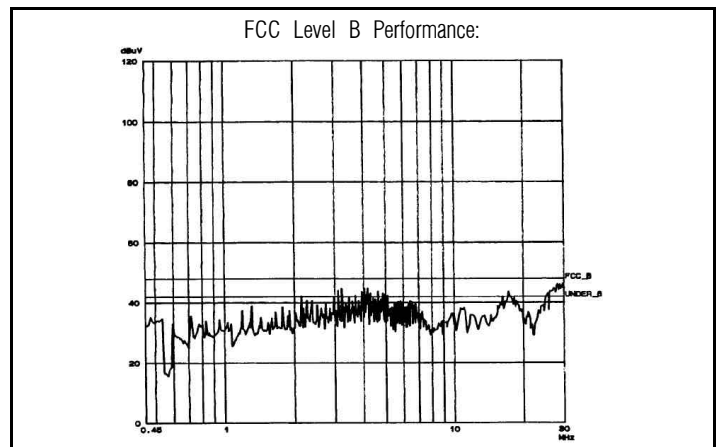
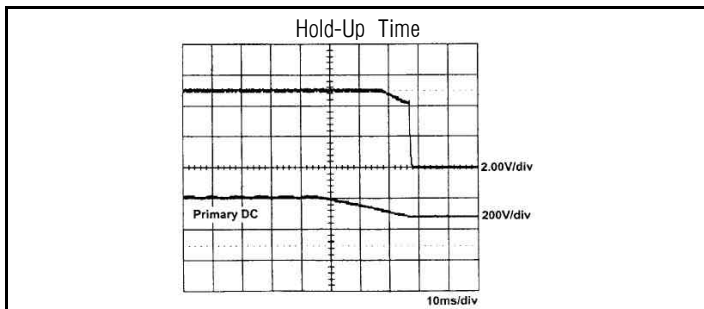
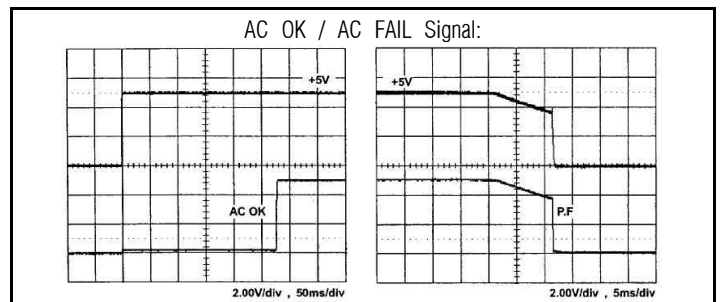
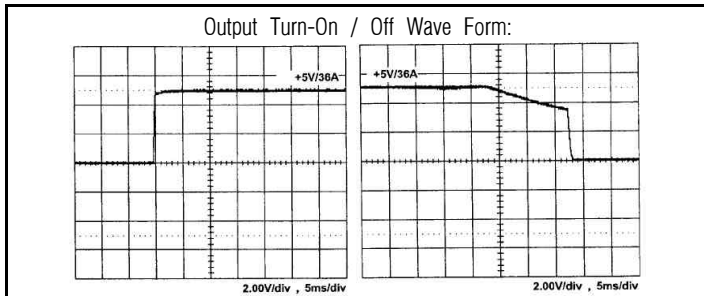
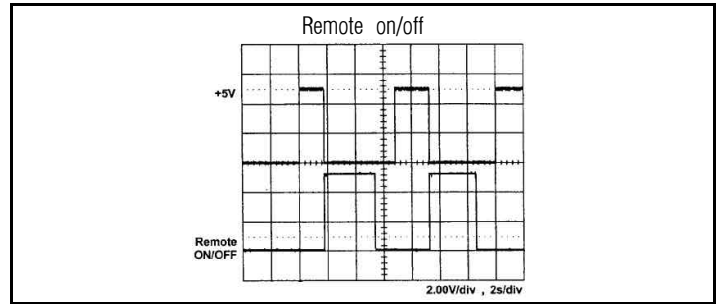
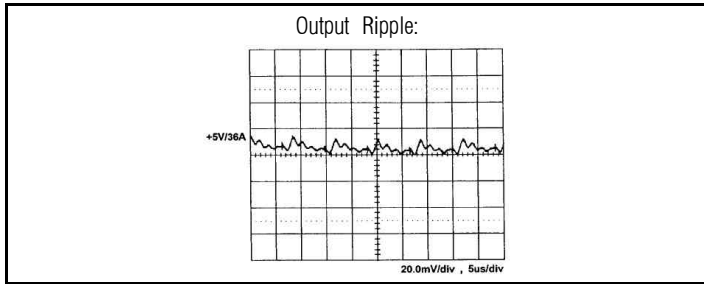

Section 10: Characteristic Curves JPS250PS12

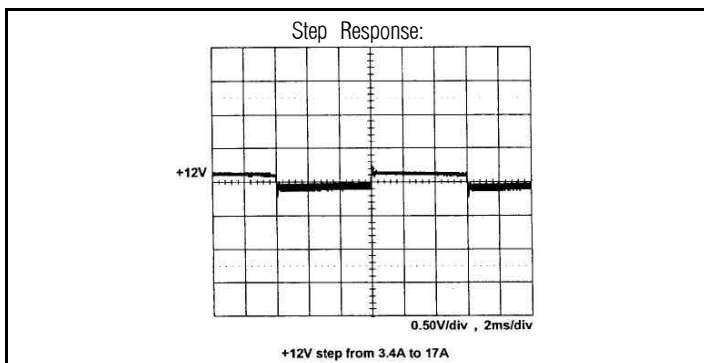
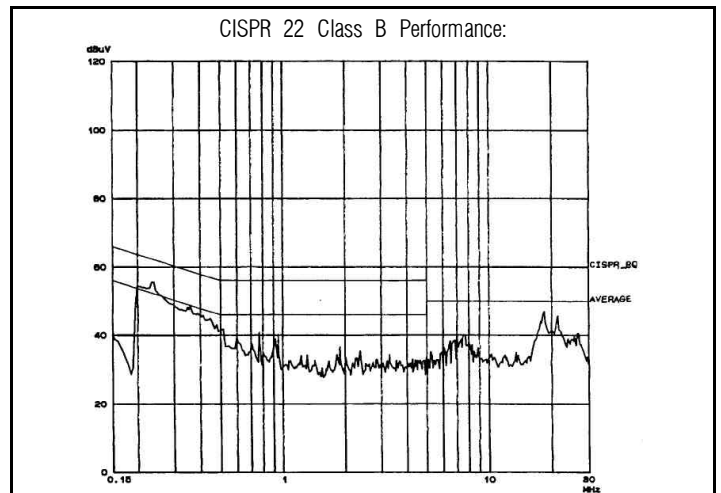
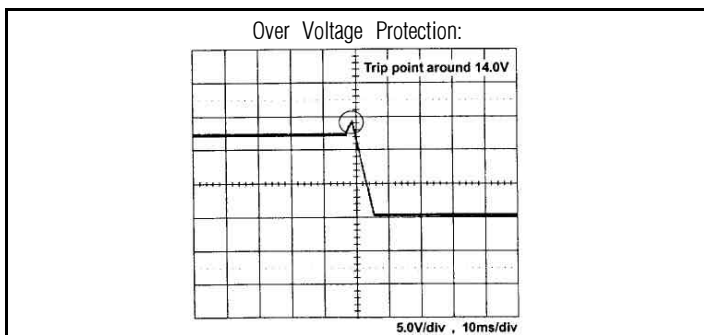
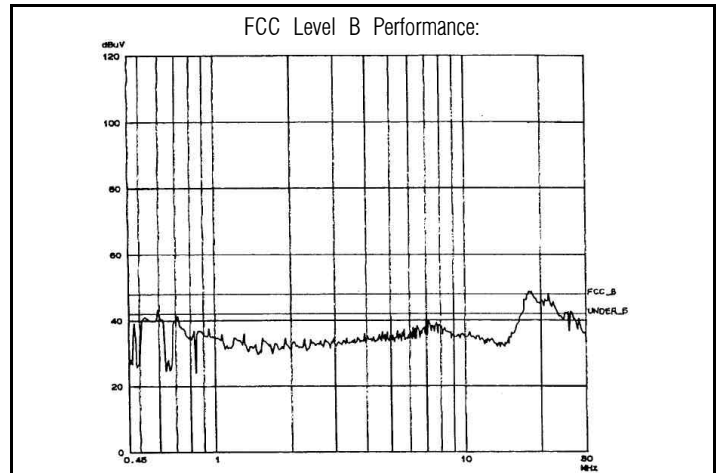
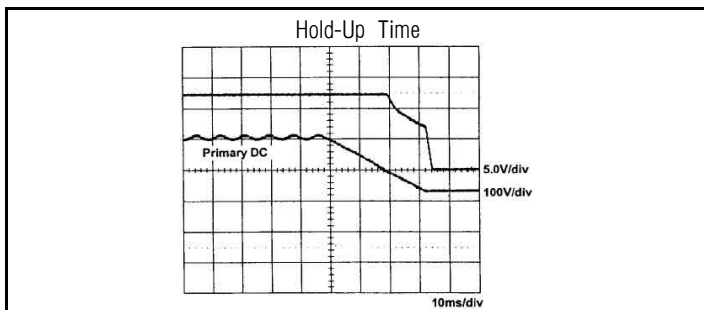
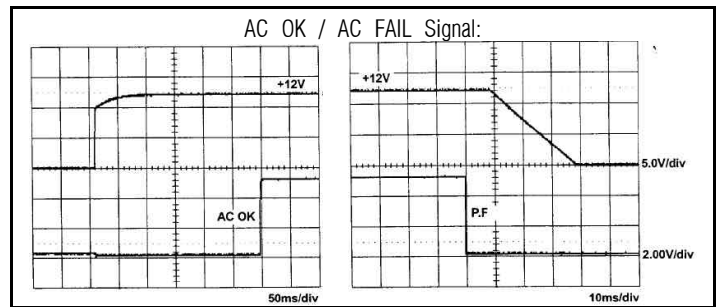
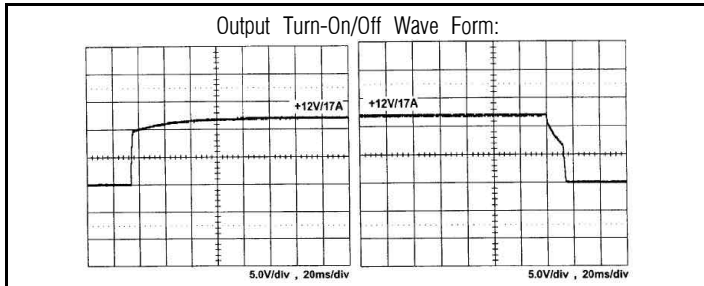
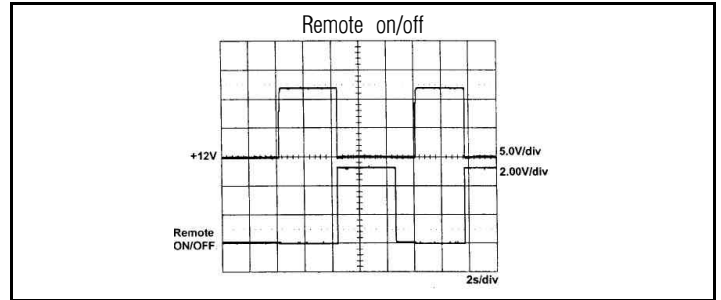
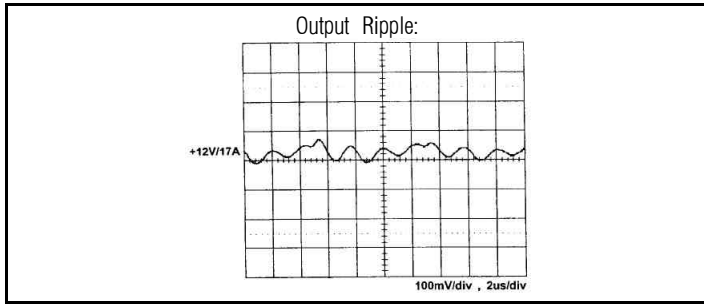

Section 10: Characteristic Curves JPS250PS15

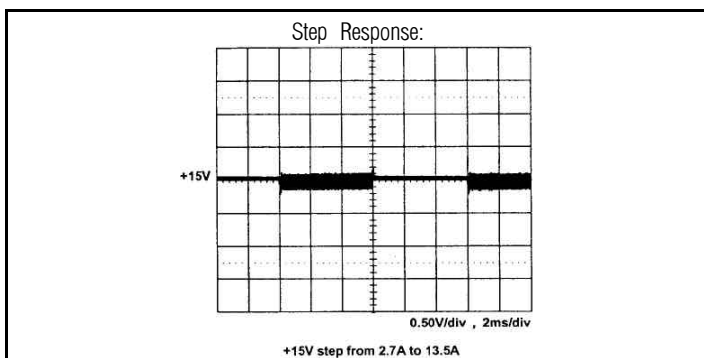
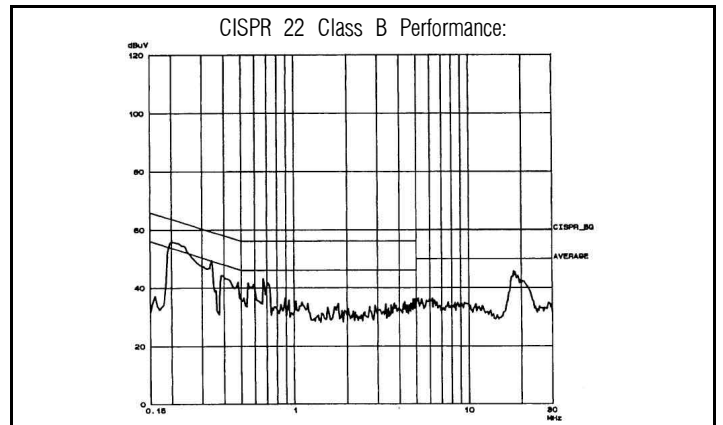
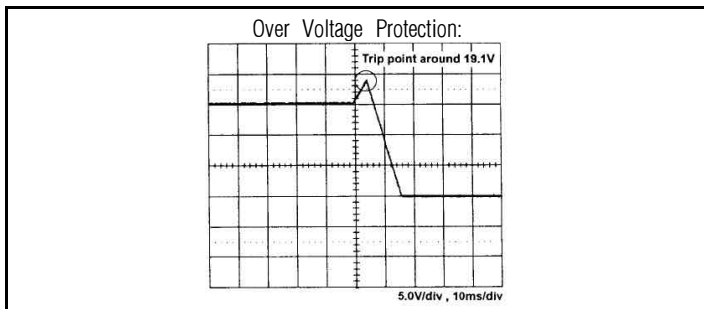
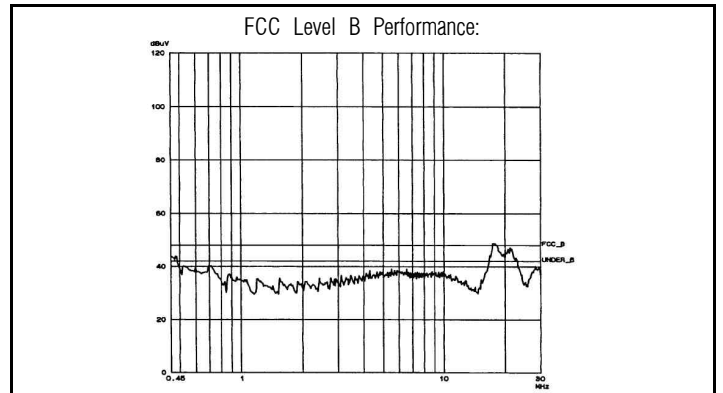
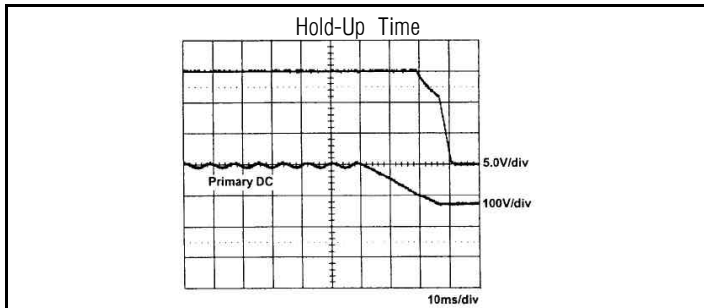
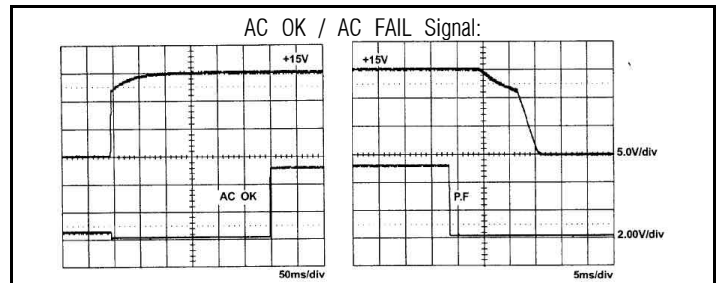
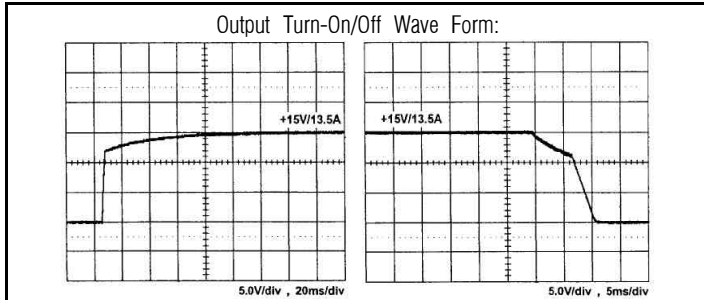
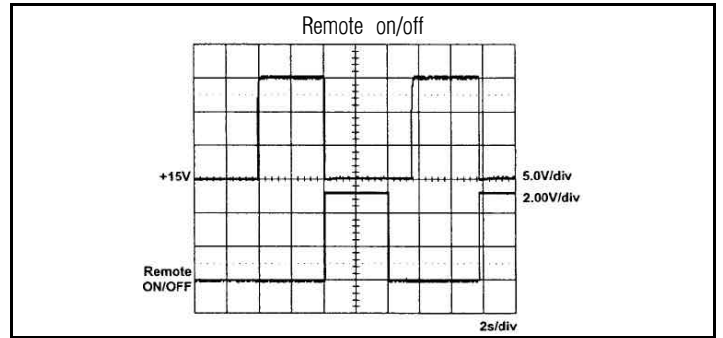
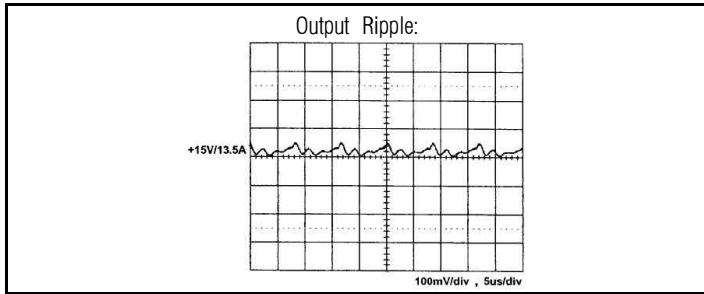

Section 10: Characteristic Curves JPS250PS24

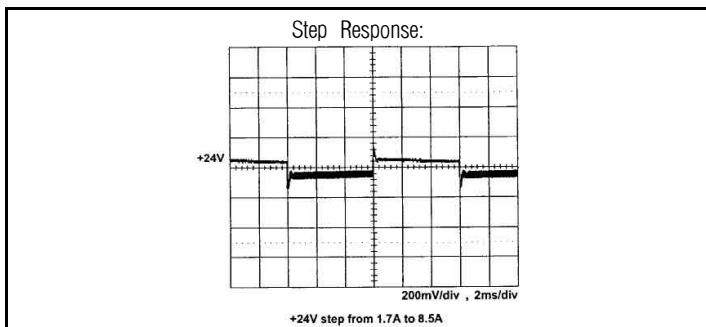
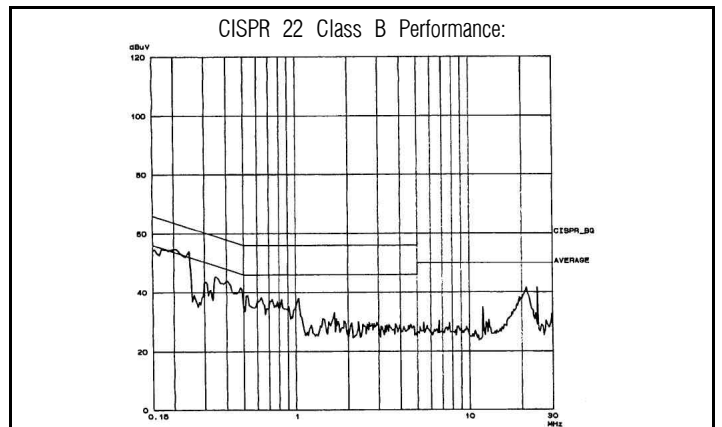
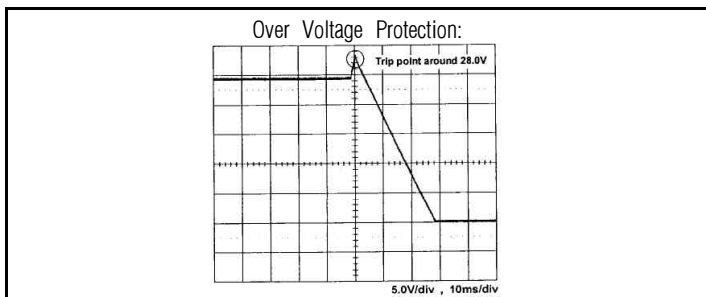
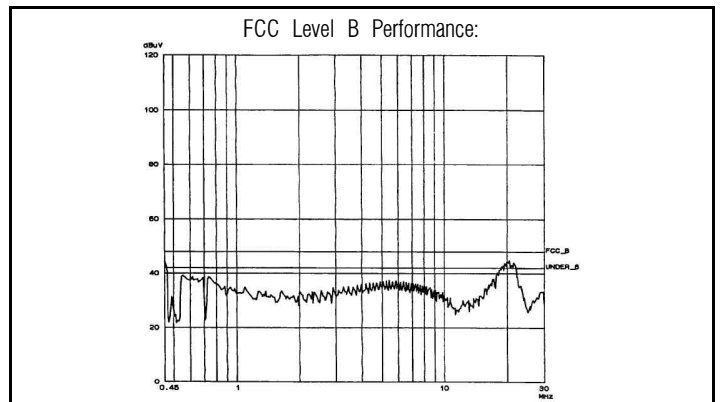
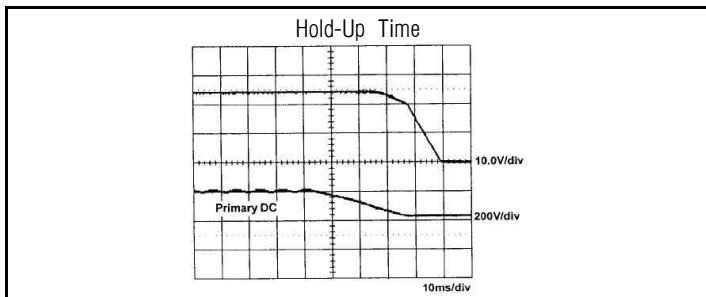
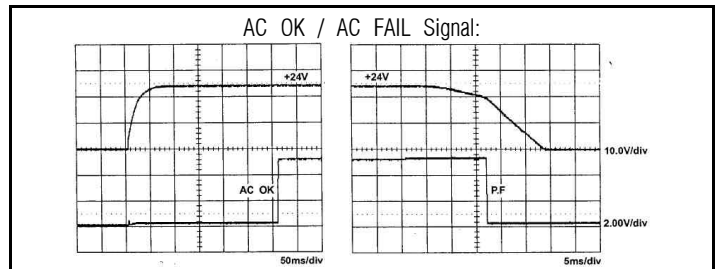
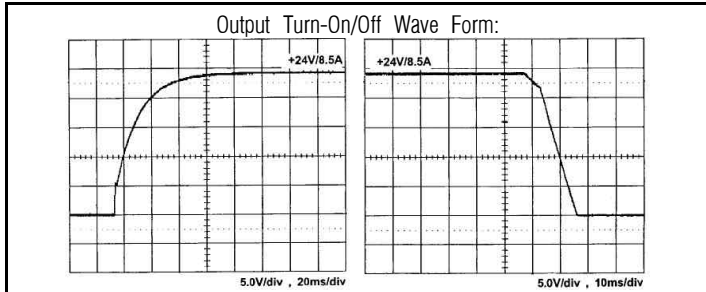
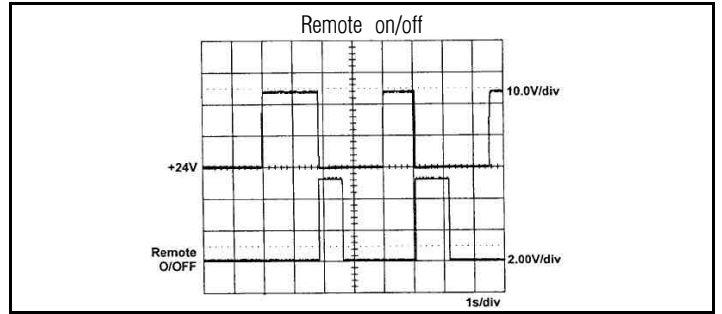
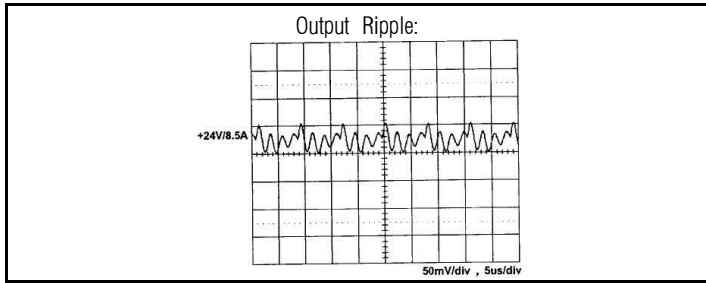

Section 10: Characteristic Curves JPS250PS48

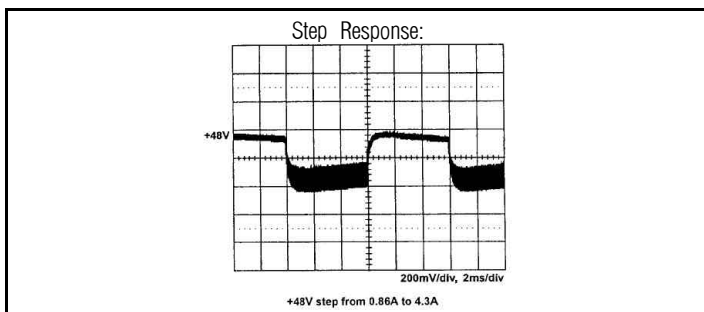
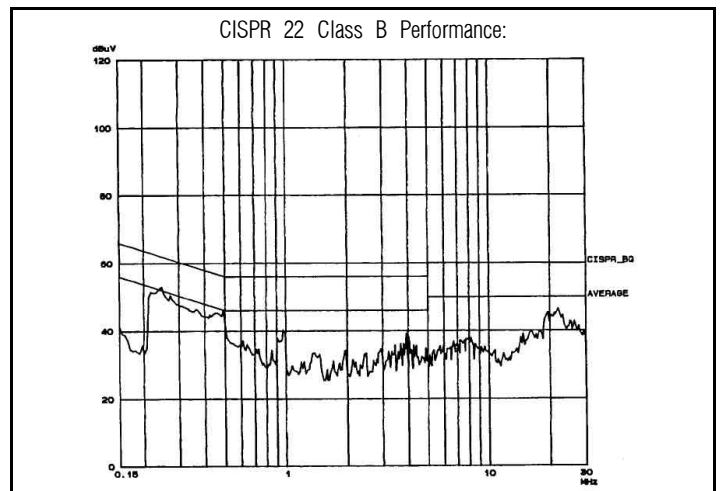
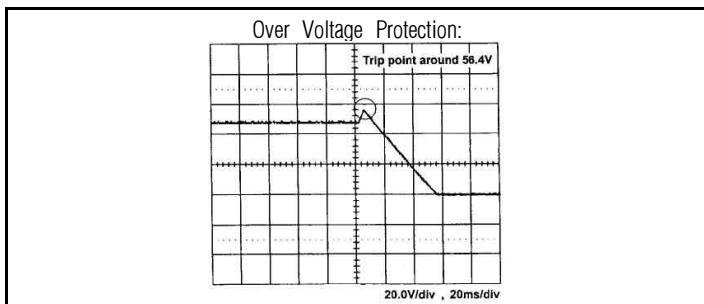
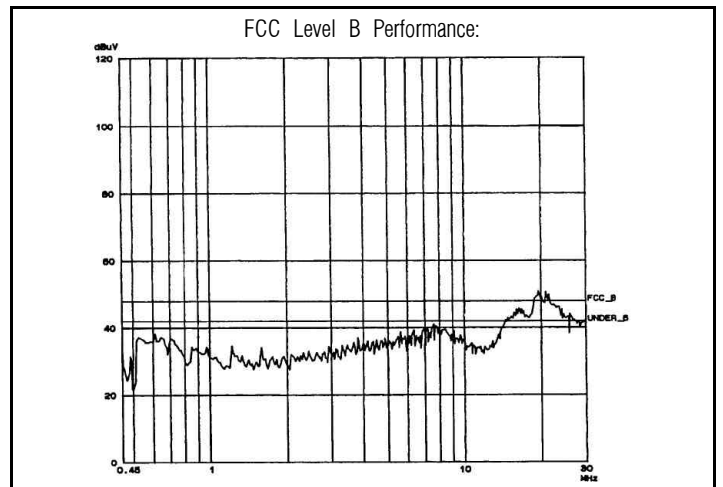
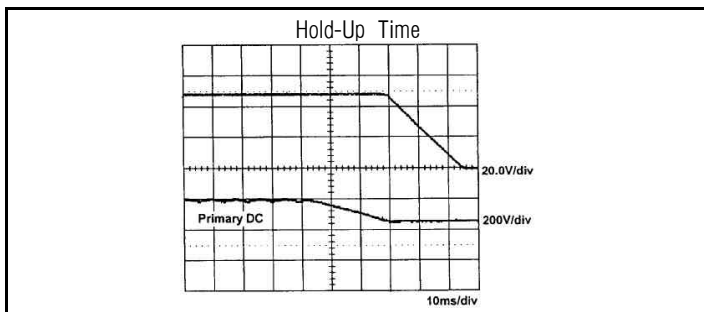
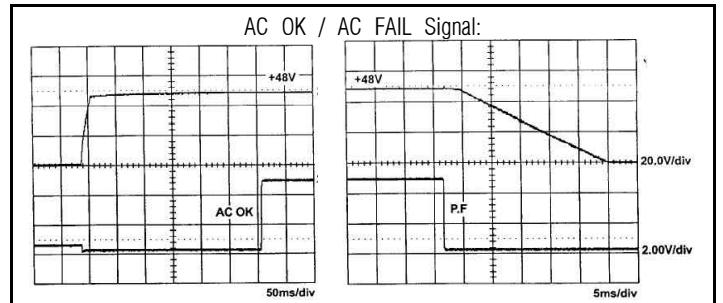
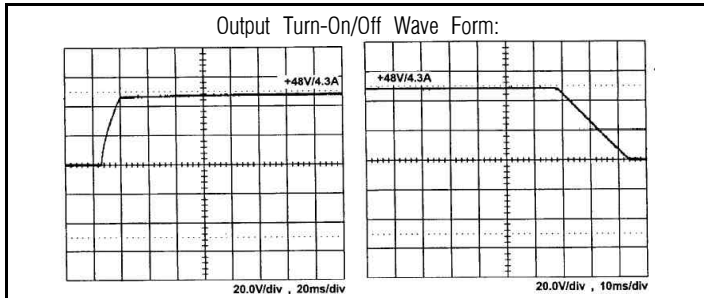
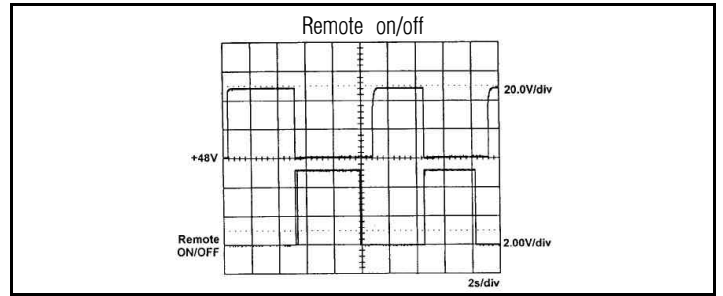
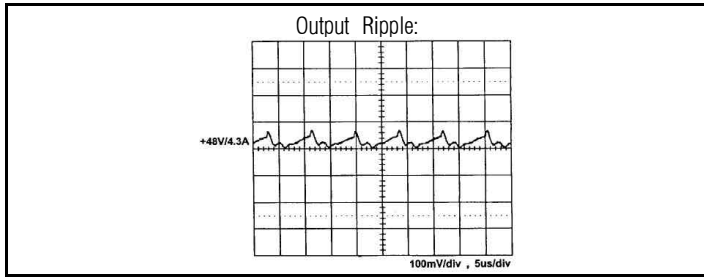

Section 11: Part Numbering & Options

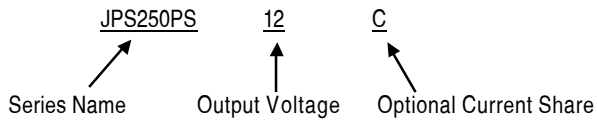

All Models come standard with the current share option. Orders for supplies without current share are built to order.

Section 12: Warranty Statement

XPIQ INC. continually strives to build the highest quality power supplies available. XPIQ INC. offers this limited warranty in the event a defect occurs with a XPIQ INC. power supply.

This limited warranty covers switching power supplies and DC/DC converters purchased from XPIQ INC. for a period of 12 months from the date of delivery. XPIQ INC. guarantees that power supplies shall be free of manufacturer's defects. The warranty is applicable to the original purchaser only and is nontransferable. This warranty will be void if any original parts have been changed or any attempt to repair a nonworking power supply has been made by anyone other than authorized XPIQ INC. personnel. This warranty is void if the power supply was used in a manner other than the specified operations range or was used in an application not intended for the power supply. This warranty is void if the power supply is altered or modified.

If a defect occurs during the warranty period, the unit(s) must be returned in accordance with the attached return policy. A copy of the original invoice or other proof of purchase must accompany the returned unit(s). XPIQ INC. reserves the right to repair or replace, at our option, any defective power supply within the warranty period. XPIQ Inc. is under no obligation to repair or replace power supplies that have components blown out by use of excessive loads or input conditions beyond the stated range of the power supply specification.

Except as specifically stated in this warranty, or in the written sales agreement between XPIQ INC. and its client, there are no other warranties, expressed or implied, but not limited to, of merchantability or fitness for a particular purpose. In no event shall XPIQ INC. be liable for loss of profit or benefits, indirect, special, consequential or other similar damages, arising out of any breach of warranty or otherwise.