

Common Source

## RF POWER MOSFETs

### N-CHANNEL ENHANCEMENT MODE

**200V 300W 45MHz**

The ARF466A and ARF466B comprise a symmetric pair of common source RF power transistors designed for push-pull scientific, commercial, medical and industrial RF power amplifier applications up to 45 MHz. They have been optimized for both linear and high efficiency classes of operation.

- **Specified 150 Volt, 40.68 MHz Characteristics:**
  - Output Power = 300 Watts.**
  - Gain = 16dB (Class AB)**
  - Efficiency = 75% (Class C)**
- **Low Cost Common Source RF Package.**
- **Low V<sub>th</sub> thermal coefficient.**
- **Low Thermal Resistance.**
- **Optimized SOA for Superior Ruggedness.**

#### MAXIMUM RATINGS

 All Ratings: T<sub>C</sub> = 25°C unless otherwise specified.

Symbol	Parameter	ARF466A_B	UNIT
V <sub>DSS</sub>	Drain-Source Voltage	1000	Volts
V <sub>DGO</sub>	Drain-Gate Voltage	1000	
I <sub>D</sub>	Continuous Drain Current @ T <sub>C</sub> = 25°C	13	Amps
V <sub>GS</sub>	Gate-Source Voltage	±30	Volts
P <sub>D</sub>	Total Power Dissipation @ T <sub>C</sub> = 25°C	357	Watts
R <sub>θJC</sub>	Junction to Case	0.35	°C/W
T <sub>J</sub> , T <sub>STG</sub>	Operating and Storage Junction Temperature Range	-55 to 150	°C
T <sub>L</sub>	Lead Temperature: 0.063" from Case for 10 Sec.	300	

#### STATIC ELECTRICAL CHARACTERISTICS

Symbol	Characteristic / Test Conditions	MIN	TYP	MAX	UNIT
BV <sub>DSS</sub>	Drain-Source Breakdown Voltage (V <sub>GS</sub> = 0V, I <sub>D</sub> = 250 μA)	1000			Volts
R <sub>DS(ON)</sub>	Drain-Source On-State Resistance <sup>①</sup> (V <sub>GS</sub> = 10V, I <sub>D</sub> = 6.5A)			0.90	ohms
I <sub>DSS</sub>	Zero Gate Voltage Drain Current (V <sub>DS</sub> = 1000V, V <sub>GS</sub> = 0V)			25	μA
	Zero Gate Voltage Drain Current (V <sub>DS</sub> = 800V, V <sub>GS</sub> = 0V, T <sub>C</sub> = 125°C)			250	
I <sub>GSS</sub>	Gate-Source Leakage Current (V <sub>GS</sub> = ±30V, V <sub>DS</sub> = 0V)			±100	nA
g <sub>fs</sub>	Forward Transconductance (V <sub>DS</sub> = 25V, I <sub>D</sub> = 6.5A)	3.3	7	9	mhos
V <sub>GS</sub> (TH)	Gate Threshold Voltage (V <sub>DS</sub> = V <sub>GS</sub> , I <sub>D</sub> = 1mA)	2		4	Volts

 **CAUTION:** These Devices are Sensitive to Electrostatic Discharge. Proper Handling Procedures Should Be Followed.

## DYNAMIC CHARACTERISTICS

ARF466A\_B

Symbol	Characteristic	Test Conditions	MIN	TYP	MAX	UNIT
$C_{iss}$	Input Capacitance	$V_{GS} = 0V$ $V_{DS} = 150V$ $f = 1 \text{ MHz}$		2000		pF
$C_{oss}$	Output Capacitance			165		
$C_{rss}$	Reverse Transfer Capacitance			75		
$t_{d(on)}$	Turn-on Delay Time	$V_{GS} = 15V$ $V_{DD} = 500V$ $I_D = 13A @ 25^\circ C$ $R_G = 1.6\Omega$		TBD		ns
$t_r$	Rise Time			TBD		
$t_{d(off)}$	Turn-off Delay Time			TBD		
$t_f$	Fall Time			TBD		

## FUNCTIONAL CHARACTERISTICS

Symbol	Characteristic	Test Conditions	MIN	TYP	MAX	UNIT
$G_{PS}$	Common Source Amplifier Power Gain	$f = 40.68 \text{ MHz}$	14	16		dB
$\eta$	Drain Efficiency	$V_{GS} = 2.5V$ $V_{DD} = 150V$	70	75		%
$\psi$	Electrical Ruggedness VSWR 10:1	$P_{out} = 300W$	No Degradation in Output Power			

① Pulse Test: Pulse width < 380μs, Duty Cycle < 2%

APT Reserves the right to change, without notice, the specifications and information contained herein.

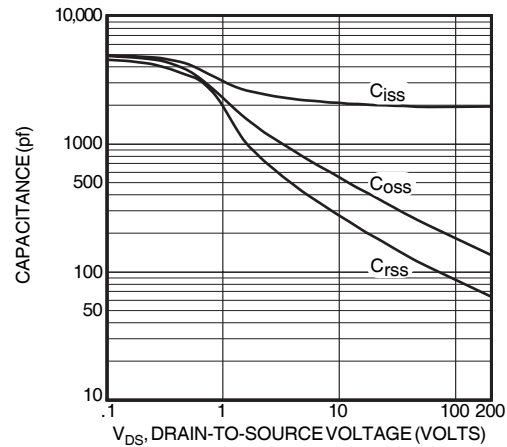

Figure 2, Typical Capacitance vs. Drain-to-Source Voltage

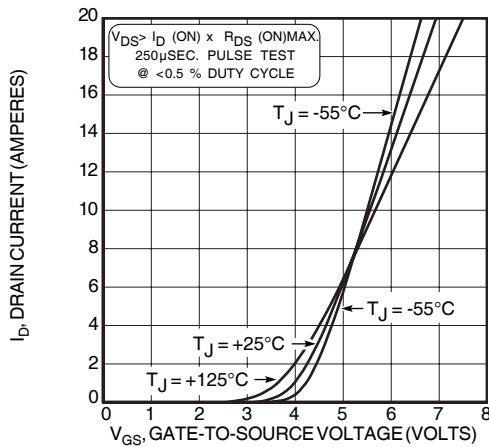

Figure 3, Typical Transfer Characteristics

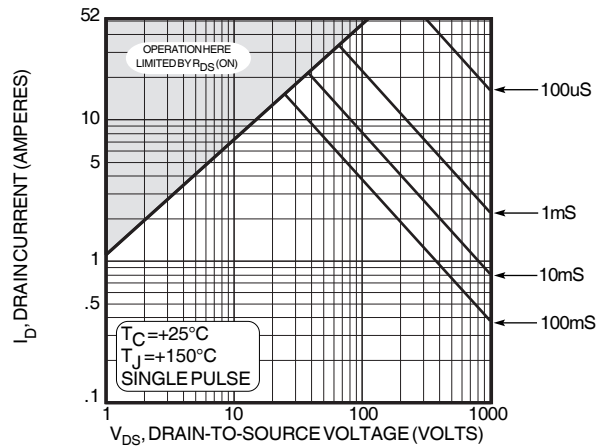
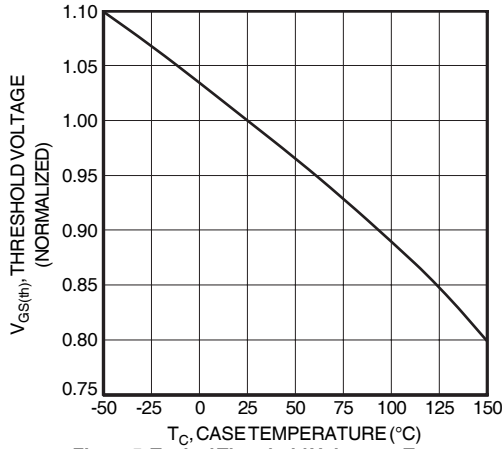

Figure 4, Typical Maximum Safe Operating Area

**TYPICAL PERFORMANCE CURVES**

**ARF466A\_B**



**Figure 5, Typical Threshold Voltage vs Temperature**

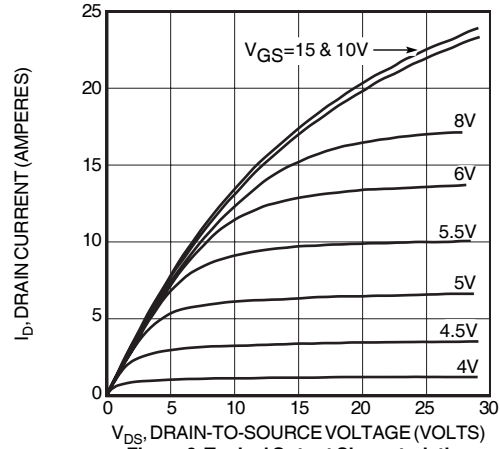

**Figure 6, Typical Output Characteristics**

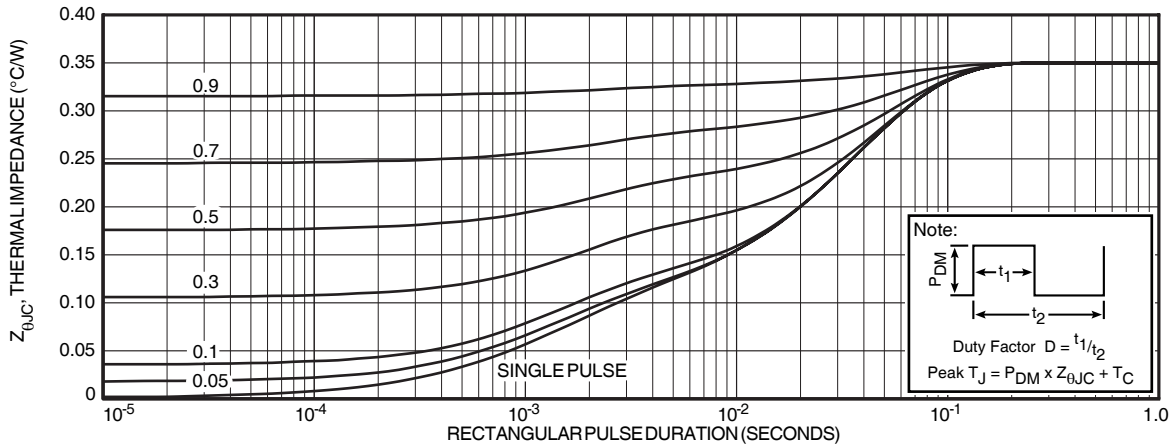

**FIGURE 7a, MAXIMUM EFFECTIVE TRANSIENT THERMAL IMPEDANCE, JUNCTION-TO-CASE vs PULSE DURATION**

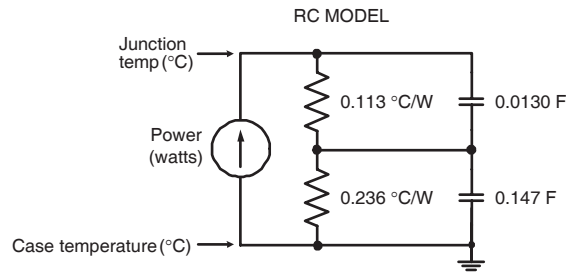

**Figure 7b, TRANSIENT THERMAL IMPEDANCE MODEL**

**Table 1 - Typical Class AB Large Signal Input - Output Impedance**

Freq. (MHz)	Z <sub>IN</sub> (Ω)	Z <sub>OL</sub> (Ω)
2.0	17.9 - j 11.2	30 - j 1.7
13.5	1.1 - j 4.9	25.7 - j 9.8
27.1	.25 - j 1.5	18 - j 13.3
40.7	.15 - j 0.9	12 - j 12.6
65	.31 + j 2.0	6.2 - j 8.9

Z<sub>IN</sub> - Gate shunted with 25Ω

I<sub>DQ</sub> = 100mA

Z<sub>OL</sub> - Conjugate of optimum load for 300W output at V<sub>dd</sub> = 150V

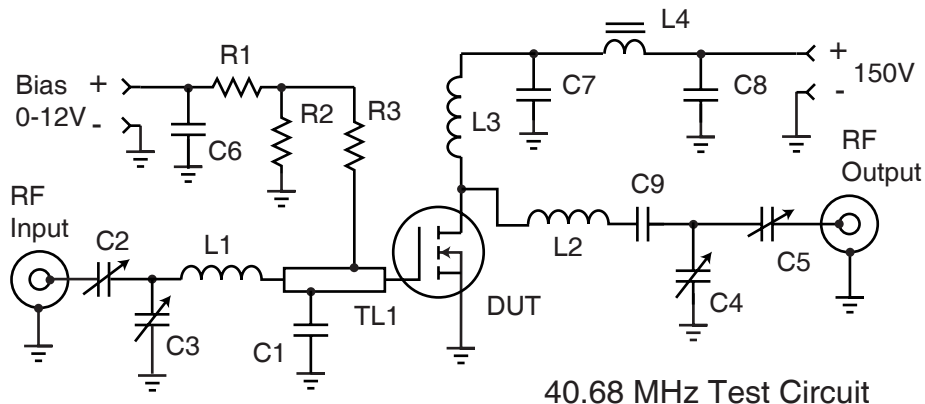

40.68 MHz Test Circuit

- |                                 |  |                                    |
|---------------------------------|--|------------------------------------|
| C1 -- 2200 pF ATC 700B          | L1 -- 4t #22 AWG .25"ID .25 "L ~87nH   | R1- R3 -- 1k W 0.5Ω Carbon         |
| C2-C5 -- Arco 465 Mica trimmer  | L2 -- 5t #16 AWG .312" ID .35"L ~176nH | TL1 -- 38Ω t-line .175 x 1 in long |
| C6-C8 -- .1μF 500V ceramic chip | L3 -- 10t #24 AWG .25"ID ~.5μH         | C1 .45" from gate pin.             |
| C9 -- 3x 2200 pF 500V chips COG | L4 -- VK200-4B ferrite choke 3μH       | DUT = ARF466A/B                    |

TO-264 (L) Package Outline

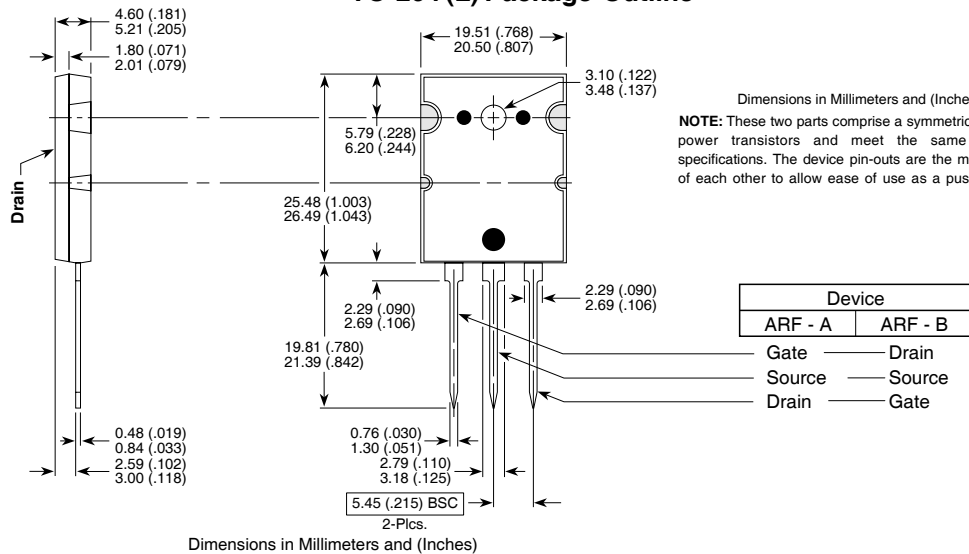

APT's products are covered by one or more of U.S. patents 4,895,810 5,045,903 5,089,434 5,182,234 5,019,522 5,262,336 6,503,786 5,256,583 4,748,103 5,283,202 5,231,474 5,434,095 5,528,058 and foreign patents. US and Foreign patents pending. All Rights Reserved.