

MT0318-WH

Features

High Intensity
 Reliable Rugged
 5mm Package
 Low Current Requirements
 IC Compatible

Maximum Ratings (Ta=25°C)

Characteristic	Symbol	Max.	Unit
Forward Current	I _F	20	mA
Reverse Voltage	V _R	5	V
Power Dissipation	P _D	80.00	mW
Operating Temperature	T _{opr}	-25 ~ +85	°C
Storage Temperature	T _{stg}	-40 ~ +100	°C
Soldering Temperature	T _{sol}	260	°C
Soldering Time	-	for 3 sec. max	-

Opto-Electrical Characteristics (Ta=25°C)

Characteristic	Symbol	Test Condition	Min	Typ	Max	Unit
Forward Voltage	V _F	I _F =20mA	-	3.60	4.00	V
Reverse Current	I _R	V _R =5V	-	-	50	A
Luminous Intensity	I _v	I _F =20mA	3530.00	5880.00	-	mcd
Viewing Angle	2θ ^{1/2}	-	-	10°	-	deg.
Peak Wavelength	λ _p	I _F =20mA	-	465	-	nm
Dominant Wavelength	λ _d	I _F =20mA	-	X=.31, Y=.32	-	nm
Spectral Line Half Width	Δλ	I _F =20mA	-	28	-	nm

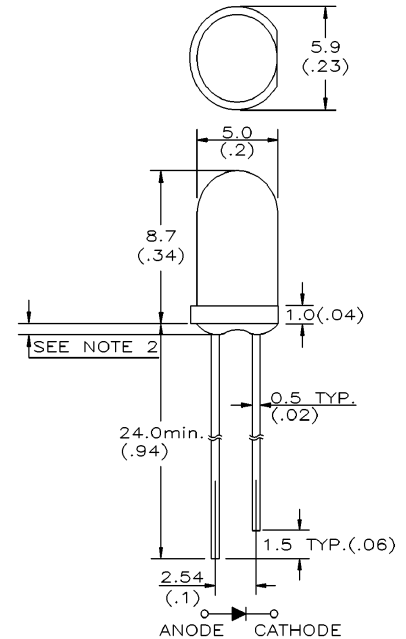

Notes :

1. All dimensions are in millimeters (inches).
2. Protruded resin under flange is 1.0mm (.04") max.
3. Tolerance is ±0.25mm (0.01") unless otherwise noted.

Company Headquarters

120 Broadway
 Menands, New York 12204
 Toll Free: 800.984.5337
 Fax: 518.432.7454

West Coast Sales Office

950 South Coast Drive, Suite 265
 Costa Mesa, California 92626
 Toll Free: 800.984.5337
 Fax: 714.850.9314

MT0318-WH Graphs

Typical Electrical / Optical Characteristics Curves :

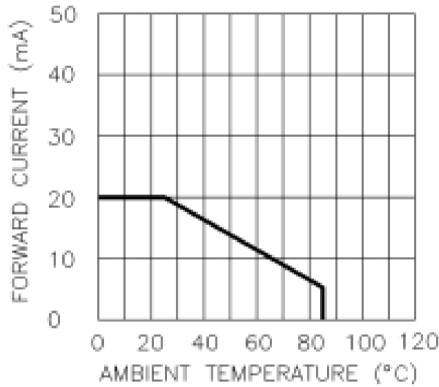

Forward Current vs. Ambient Temperature

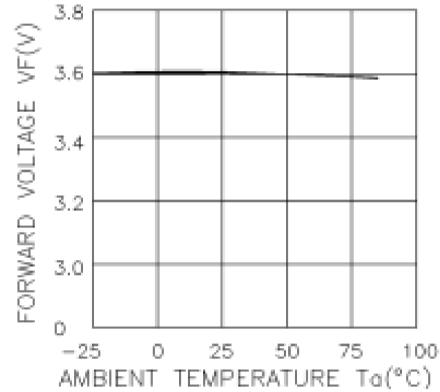

Forward Voltage vs. Ambient Temperature

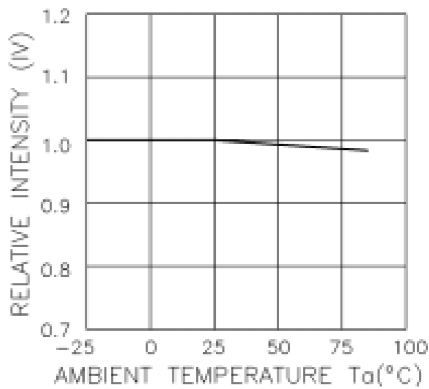

Relative Intensity vs. Ambient Temperature

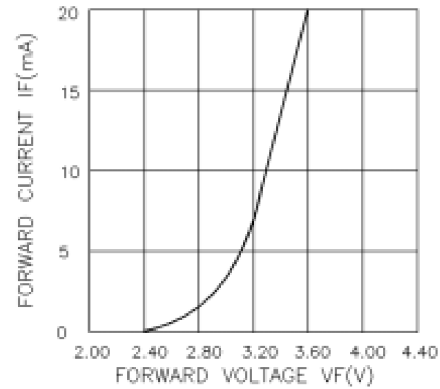

Forward Current vs. Forward Voltage

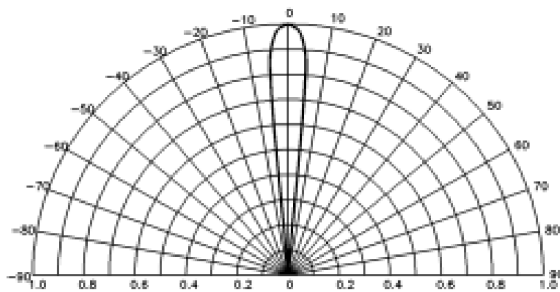

Radiation Diagram

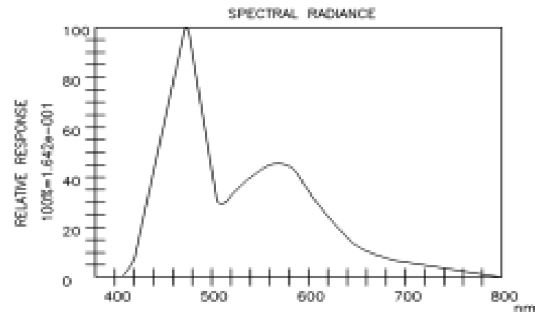

Luminous Spectrum (Ta=25°C)