

MW010-Series Power Modules: 36 Vdc to 72 Vdc Inputs; 10 W



The MW010-Series Power Modules are encapsulated in nonconductive cases measuring 2.00 in. long, 1.60 in. wide, and 0.50 in. high.

Description

The MW010A, B, C, BK, and CL Power Modules are dc-dc converters that operate over an input-voltage range of 36 Vdc to 72 Vdc and provide precisely regulated dc outputs. The outputs are fully isolated from the inputs, allowing versatile polarity configurations and grounding connections. The modules have maximum power ratings of 10 W at a typical full-load efficiency of 83% (80% for the MW010A).

The modules are encapsulated in nonconductive cases that mount on PC boards. In a natural convection environment, the modules are rated to full load at 85 °C with no heat sinking or external filtering.

For applications requiring remote on/off, the MW010A1, B1, C1, BK1, and CL1 Power Modules are available. These modules are equivalent to the previously described modules, except for the addition of the remote on/off and associated terminal.

Features

- Small size: 2.00 in. x 1.60 in. x 0.50 in.
- Wide input voltage range: 36 Vdc to 72 Vdc
- Output current limiting, unlimited duration
- Output overvoltage clamp
- Load regulation: 0.15% max. (MW010A, B, C)
- Line regulation: 0.10% max. (MW010A, B, C)
- Input undervoltage lockout
- Input-to-output isolation
- No external filtering required
- Operating ambient temperature range: -40 °C to +85 °C
- Meets FCC Class A requirements for radiated emissions
- High reliability
- Remote on/off available
- UL recognized (UL 1950)
- CSA and TUV recognition available

Applications

- Telecommunications
- Distributed power architecture

**MW010-Series Power Modules:
36 Vdc to 72 Vdc Inputs; 10 W**

Absolute Maximum Ratings

Ratings apply to all devices.

Stresses in excess of the Absolute Maximum Ratings can cause permanent damage to the device. These are absolute stress ratings only. Functional operation of the device is not implied at these or any other conditions in excess of those given in the operations sections of the data sheet. Exposure to Absolute Maximum Ratings for extended periods can adversely affect device reliability.

Parameter	Symbol	Min	Max	Unit
Input Voltage:				
Continuous	V_I	—	72	V
Transient (<1 s)	$V_{I, trans}$	—	75	V
I/O Isolation Voltage	—	—	500	V
Operating Ambient Temperature (60 ft./min. natural convection)	T_A	-40	85	°C
Storage Temperature	T_{stg}	-40	100	°C

Electrical Specifications

Unless otherwise indicated, specifications apply to all devices over all operating input voltage, resistive load, and temperature conditions.

Table 1. Input Specifications

Parameter	Symbol	Min	Typ	Max	Unit
Operating Input Voltage	V_I	36	48	72	V
Maximum Input Current ($V_I = 0$ V to 72 V; $I_O = I_{O, max}$; see Figure 1.)	$I_{I, max}$	—	—	625	mA
Inrush Transient	i^2t	—	0.3	1.0	A ² s
Input Reflected-ripple Current, Peak-to-peak (5 Hz to 20 MHz; 12 μ H source impedance; $T_A = 25$ °C; see Figure 19 and Design Considerations section.)	—	—	25	—	mA p-p
Input Ripple Rejection (120 Hz)	—	—	50	—	dB

UL Fusing Considerations

CAUTION: This power module is not internally fused. An input line fuse must always be used.

This encapsulated power module can be used in a wide variety of applications, ranging from simple stand-alone operation to an integrated part of a sophisticated power architecture. To preserve maximum flexibility, internal fusing is not included; however, to achieve maximum safety and system protection, always use an input line fuse. The *Underwriters Laboratories Conditions of Acceptability* requires a normal-blow, dc fuse with a maximum rating of 5 A in series with the input. Based on the information provided in this data sheet on inrush energy and maximum dc input current, the same type of fuse with a lower rating can be used. However, for UL recognition, the dc rating of the fuse must not exceed 5 A. Refer to the fuse manufacturer's data for further information.

Electrical Specifications (continued)

Table 2. Output Specifications

Parameter	Device	Symbol	Min	Typ	Max	Unit
Output Voltage (Over all operating input voltage, resistive load, and temperature conditions until end of life. For dual-output modules, see Figures 2 and 3.)	MW010A	V_o	4.80	—	5.25	Vdc
	MW010B	V_o	11.4	—	12.6	Vdc
	MW010C	V_o	14.25	—	15.75	Vdc
	MW010BK	V_{o1}	10.8	—	13.2	Vdc
		V_{o2}	-10.8	—	-13.2	Vdc
	MW010CL	V_{o1}	13.5	—	16.5	Vdc
		V_{o2}	-13.5	—	-16.5	Vdc
Output Voltage Set Point ($V_i = 48$ V; $I_o = I_{o, \max}$; $T_A = 25$ °C)	MW010A	$V_{o, \text{set}}$	4.85	5.0	5.20	Vdc
	MW010B	$V_{o, \text{set}}$	11.52	12.0	12.48	Vdc
	MW010C	$V_{o, \text{set}}$	14.4	15.0	15.6	Vdc
	MW010BK	$V_{o1, \text{set}}$	11.4	12.0	12.6	Vdc
		$V_{o2, \text{set}}$	-11.4	-12.0	-12.6	Vdc
	MW010CL	$V_{o1, \text{set}}$	14.25	15.0	15.75	Vdc
		$V_{o2, \text{set}}$	-14.25	-15.0	-15.75	Vdc
Output Regulation: Line ($V_i = 36$ Vdc to 72 Vdc) Load ($I_o = I_{o, \min}$ to $I_{o, \max}$) Temperature ($T_A = -40$ °C to +85 °C; see Figure 4.)	MW010A, B, C	—	—	0.02	0.10	%
	MW010A, B, C	—	—	0.05	0.15	%
	MW010A	—	—	15	70	mV
	MW010B	—	—	35	150	mV
	MW010C	—	—	45	190	mV
Output Ripple and Noise Voltage (See Figure 20.): RMS Peak-to-peak (5 Hz to 20 MHz)	MW010A	—	—	—	10	mV rms
	MW010B, C	—	—	—	15	mV rms
	MW010BK, CL	—	—	—	20	mV rms
	MW010A	—	—	—	70	mV p-p
	MW010B, C	—	—	—	100	mV p-p
	MW010BK, CL	—	—	—	100	mV p-p
	Output Current (At $I_o < I_{o, \min}$, the modules may exceed output ripple specifications and dual-output modules may exceed specified output voltages.)	MW010A	I_o	0.1	—	2.0
MW010B		I_o	0.04	—	0.83	A
MW010C		I_o	0.03	—	0.67	A
MW010BK		I_{o1}	0.04	—	0.42	A
		I_{o2}	0.04	—	0.42	A
MW010CL		I_{o1}	0.03	—	0.33	A
		I_{o2}	0.03	—	0.33	A
Output Current-limit Inception: $V_o = 4.5$ V (See Figure 5.) $V_o = 10.8$ V (See Figure 6.) $V_o = 13.5$ V (See Figure 6.) V_{o1} or $V_{o2} = 10.2$ V (See Figure 7.) V_{o1} or $V_{o2} = 12.75$ V (See Figure 7.)		MW010A	—	—	3.7	5.5
	MW010B	—	—	1.5	2.5	A
	MW010C	—	—	1.3	2.4	A
	MW010BK	—	—	1.4	2.5	A
	MW010CL	—	—	1.3	2.4	A

**MW010-Series Power Modules:
36 Vdc to 72 Vdc Inputs; 10 W**

Electrical Specifications (continued)

Table 2. Output Specifications (continued)

Parameter	Device	Symbol	Min	Typ	Max	Unit
Output Current Limit: V _o = 1.0 V	MW010A	—	—	—	6.3	A
V _o = 1.0 V	MW010B, C	—	—	—	3.0	A
V _{o1} or V _{o2} = 1.0 V	MW010BK, CL	—	—	—	3.0	A
Output Short-circuit Current (V _o = 250 mV)	MW010A	—	—	3.5	—	A
	MW010B, C, BK, CL	—	—	1.0	—	A
Efficiency (V _i = 48 V; I _o = I _{o, max} ; T _A = 25 °C; see Figures 8, 9, 21, and 22.)	MW010A	η	77	80	—	%
	MW010B, C, BK, CL	η	80	83	—	%
Dynamic Response (For MW010BK and CL, I _{o1} or I _{o2} = I _{o, max} ; ΔI _o /Δt < 1 A/10 μs, V _i = 48 V, T _A = 25 °C): Load Change from I _o = 50% to 75% of I _{o, max} (See Figures 10, 11, and 12.): Peak Deviation	MW010A	—	—	140	—	mV
	MW010B, C, BK, CL	—	—	200	—	mV
Settling Time (V _o < 10% peak deviation)	all	—	—	3.0	—	ms
Load Change from I _o = 50% to 25% of I _{o, max} (See Figures 13, 14, and 15.): Peak Deviation	MW010A	—	—	140	—	mV
	MW010B, C, BK, CL	—	—	200	—	mV
Settling Time (V _o < 10% peak deviation)	all	—	—	3.0	—	ms

Table 3. Isolation Specifications

Specifications apply to all devices.

Parameter	Min	Typ	Max	Unit
Isolation Capacitance	—	1200	—	pF
Isolation Resistance	10	—	—	MΩ

General Specifications

Specifications apply to all devices.

Parameter	Min	Typ	Max	Unit
Calculated MTBF ($I_o = 0.8(I_{o, max})$; $T_A = 40\text{ }^\circ\text{C}$)	2,500,000			hours
Weight	—	—	1.60(45.4)	oz.(g)

Feature Specifications

Unless otherwise indicated, specifications apply over all operating input voltage, resistive load, and temperature conditions. See Feature Descriptions for further information.

Parameter	Device	Symbol	Min	Typ	Max	Unit
Remote On/Off Switch (MW010A1, B1, C1, BK1, and CL1 only; $V_i = 36\text{ V to }72\text{ V}$; open collector or equivalent compatible; signal referenced to $V_i(-)$ terminal; see Feature Descriptions and Design Considerations sections.): Logic Low — Module On Logic High — Module Off Module Specifications: On/Off Current — Logic Low On/Off Voltage: Logic Low Logic High ($I_{on/off} = 0$) Open Collector Switch Specifications: Leakage Current During Logic High ($V_{on/off} = 18\text{ V}$) Output Low Voltage During Logic Low ($I_{on/off} = 1\text{ mA}$) Turn-On Time ($I_o = 0.8(I_{o, max})$; $V_o \pm 1\%$ of steady state; see Figures 16, 17, and 18.)						
	all	$I_{on/off}$	—	—	1.0	mA
	all	$V_{on/off}$	0	—	1.2	V
	all	$V_{on/off}$	—	—	18	V
	all	$I_{on/off}$	—	—	50	μA
	all	$V_{on/off}$	—	—	1.2	V
	MW010A, B, C	—	—	5	—	ms
	MW010BK, CL	—	—	15	—	ms
Undervoltage Lockout: Module On Module Off	all all	V_{UVLO} V_{UVLO}	— 20	28 28	36 —	V V
Output Overvoltage Clamp	MW010A MW010B MW010C MW010BK MW010CL	$V_{O, clamp}$ $V_{O, clamp}$ $V_{O, clamp}$ $V_{O1, clamp}$ $V_{O2, clamp}$ $V_{O1, clamp}$ $V_{O2, clamp}$	— — — — — — —	6.0 14 17 16 -16 19 -19	7.0 16.0 19.0 18.0 -18.0 21.0 -21.0	V V V V V V V

Characteristic Curves

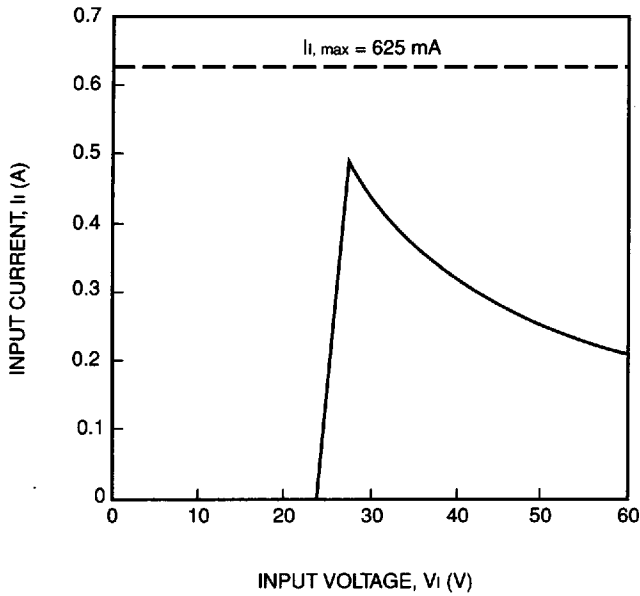

**Figure 1. Typical Input Characteristic;
 $I_o = I_{o, max}$; $T_A = 25\text{ }^\circ\text{C}$**

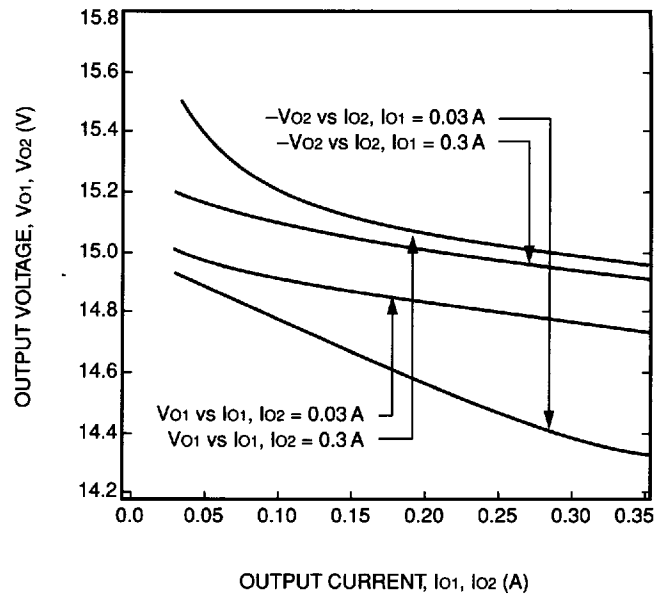

Figure 3. MW010CL Typical Output Voltage Regulation; $T_A = 25\text{ }^\circ\text{C}$; $V_i = 48\text{ V}$

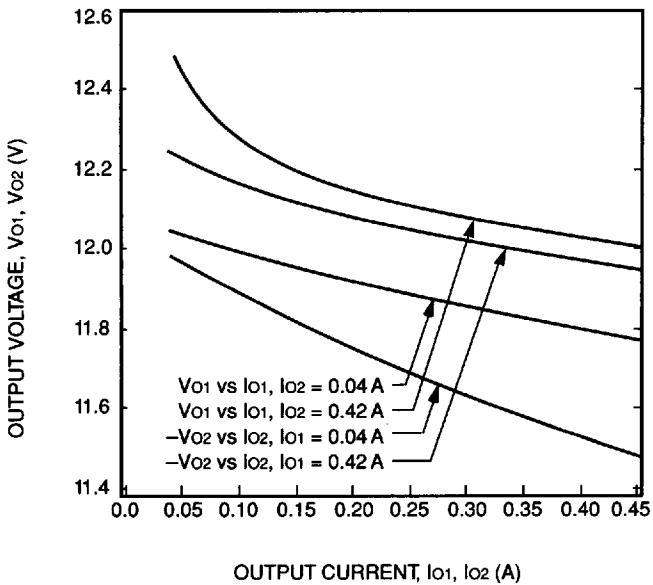

Figure 2. MW010BK Typical Output Voltage Regulation; $T_A = 25\text{ }^\circ\text{C}$; $V_i = 48\text{ V}$

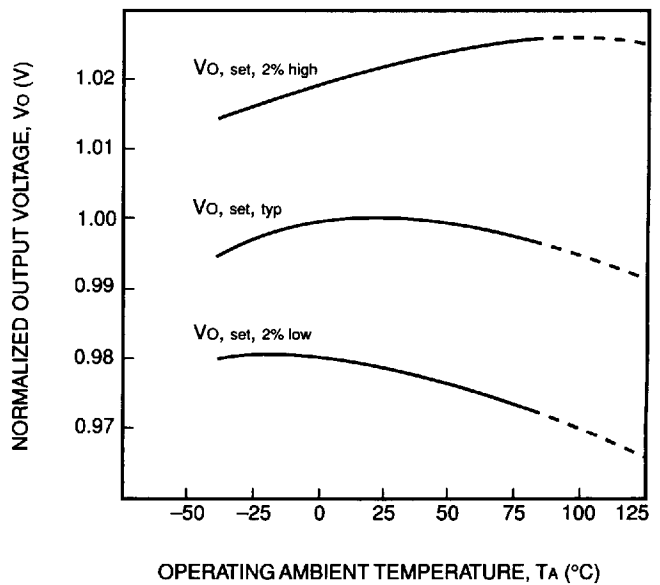

Figure 4. Typical Output Voltage Variation over Operating Ambient Temperature Range; $I_o = 0.8(I_{o, max})$; $V_i = 48\text{ V}$

Characteristic Curves (continued)

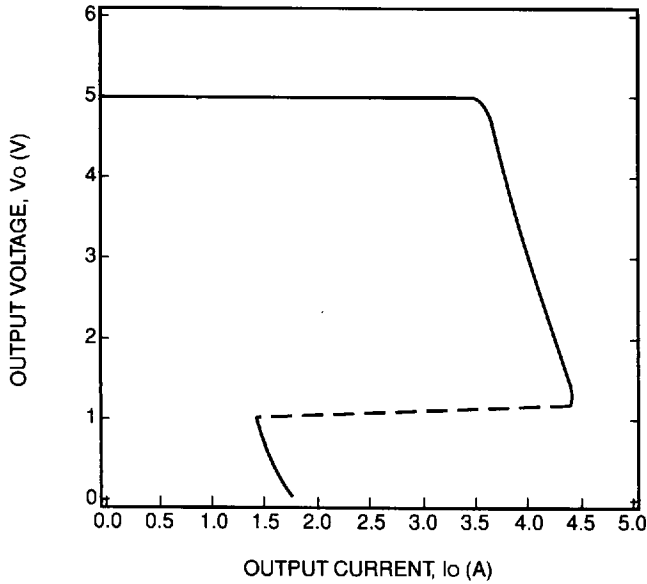

Figure 5. MW010A Typical Output Characteristic;
 $V_i = 48 \text{ V}; T_A = 25 \text{ }^\circ\text{C}$

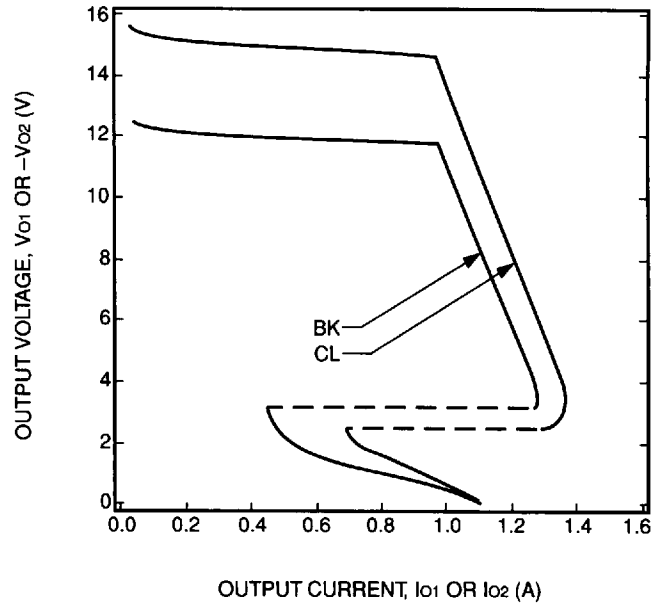

Figure 7. MW010BK, CL Typical Output Characteristic with One Output Fixed at Full Load;
 $V_i = 48 \text{ V}; T_A = 25 \text{ }^\circ\text{C}$

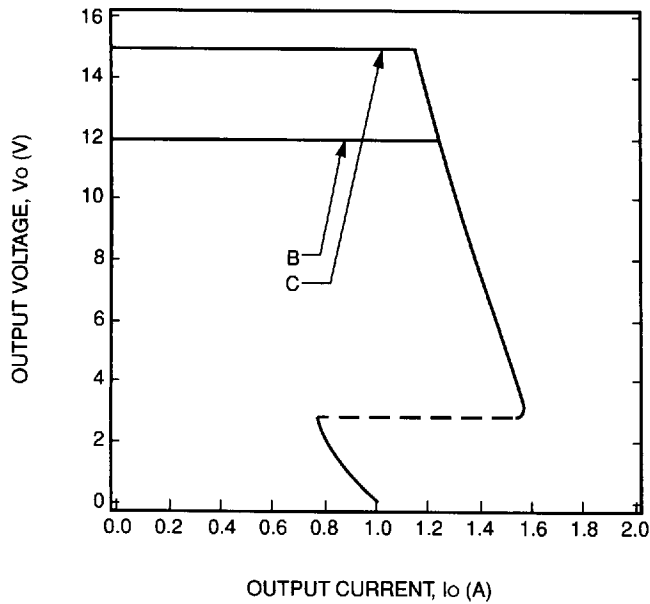

Figure 6. MW010B, C Typical Output Characteristic;
 $V_i = 48 \text{ V}; T_A = 25 \text{ }^\circ\text{C}$

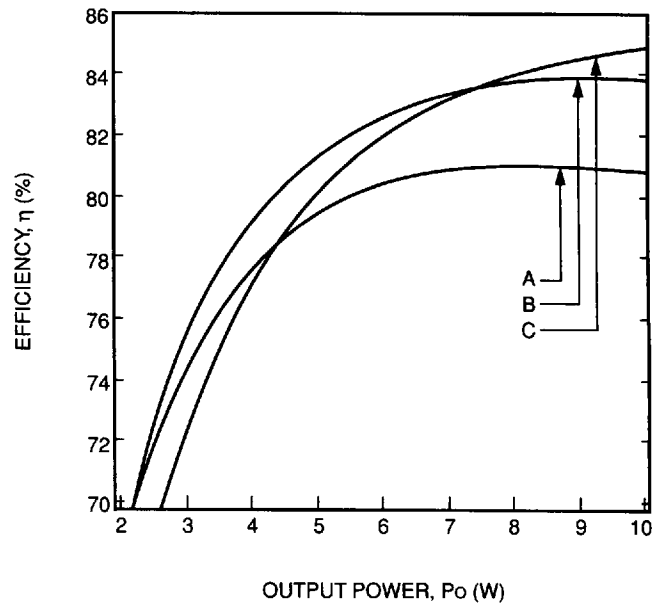

Figure 8. MW010A, B, C Typical Converter Efficiency as a Function of Output Power;
 $V_i = 48 \text{ V}; T_A = 25 \text{ }^\circ\text{C}$

Characteristic Curves (continued)

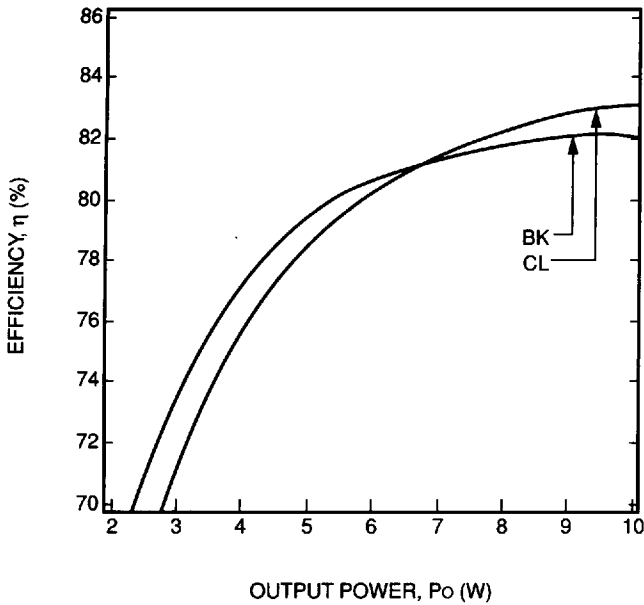

Figure 9. MW010BK, CL Typical Converter Efficiency as a Function of Output Power; $V_i = 48$ V; $T_A = 25$ °C

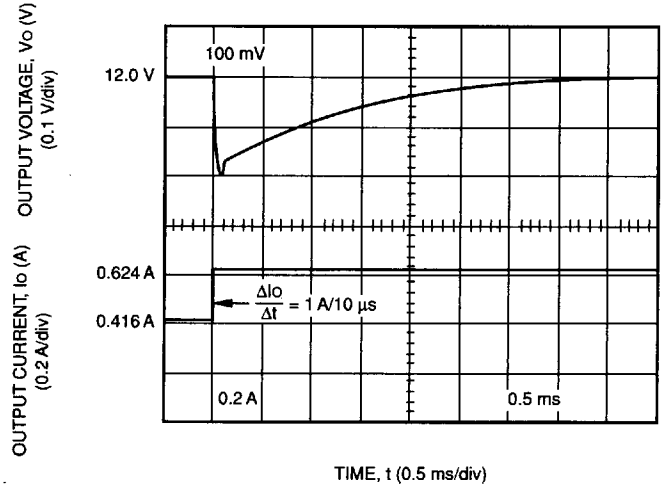

Figure 11. MW010B Typical Output Voltage Waveform for a Step Load Change from 50% to 75% of $I_{o, \text{max}}$; $V_i = 48$ V; $T_A = 25$ °C

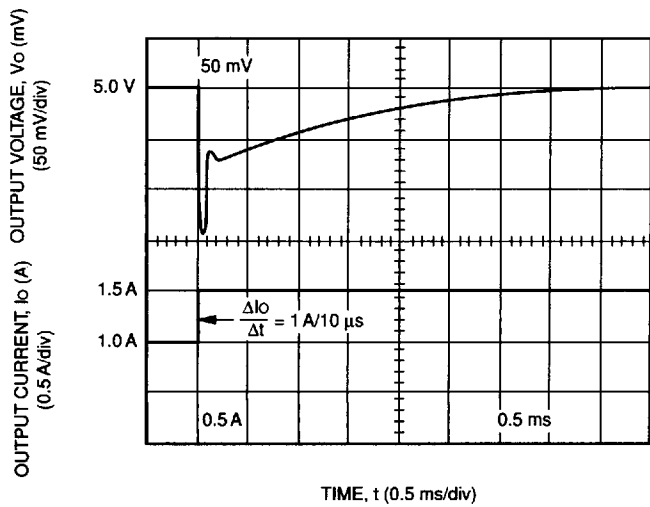

Figure 10. MW010A Typical Output Voltage Waveform for a Step Load Change from 50% to 75% of $I_{o, \text{max}}$; $V_i = 48$ V; $T_A = 25$ °C

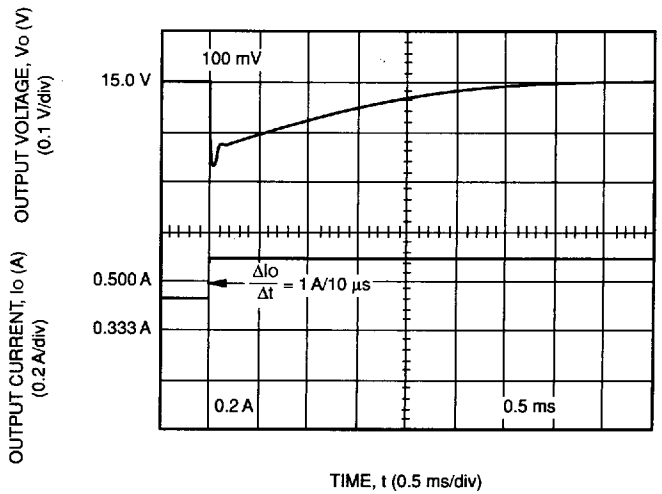

Figure 12. MW010C Typical Output Voltage Waveform for a Step Load Change from 50% to 75% of $I_{o, \text{max}}$; $V_i = 48$ V; $T_A = 25$ °C

Characteristic Curves (continued)

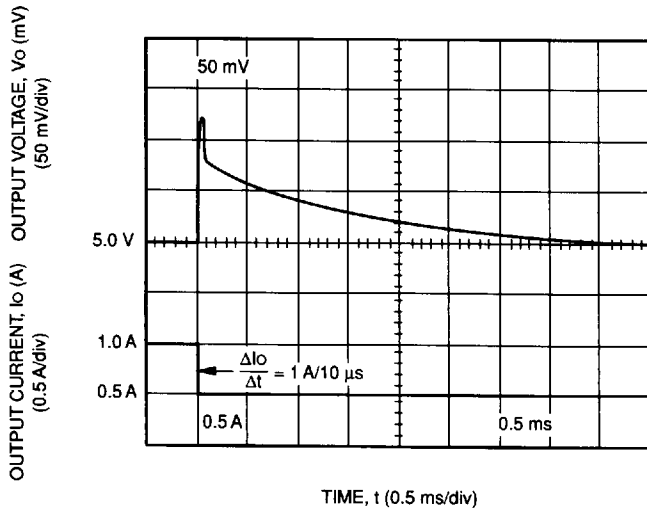

Figure 13. MW010A Typical Output Voltage Waveform for a Step Load Change from 50% to 25% of $I_{o,max}$; $V_I = 48\text{ V}$; $T_A = 25\text{ }^\circ\text{C}$

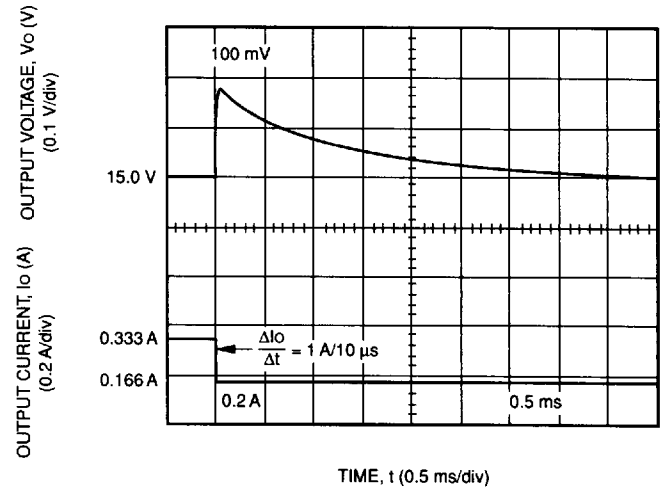

Figure 15. MW010C Typical Output Voltage Waveform for a Step Load Change from 50% to 25% of $I_{o,max}$; $V_I = 48\text{ V}$; $T_A = 25\text{ }^\circ\text{C}$

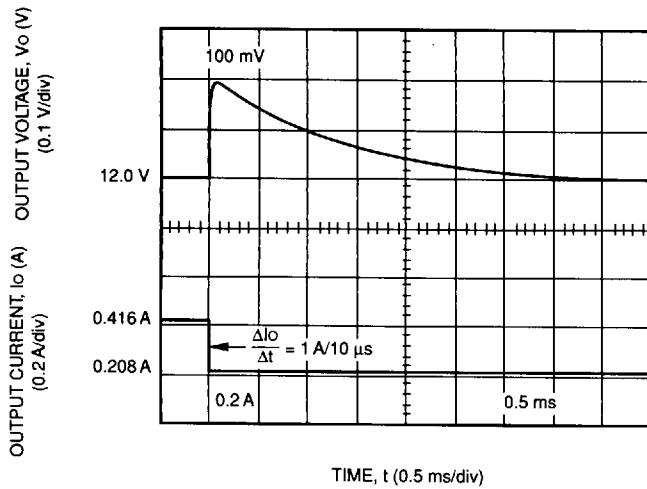

Figure 14. MW010B Typical Output Voltage Waveform for a Step Load Change from 50% to 25% of $I_{o,max}$; $V_I = 48\text{ V}$; $T_A = 25\text{ }^\circ\text{C}$

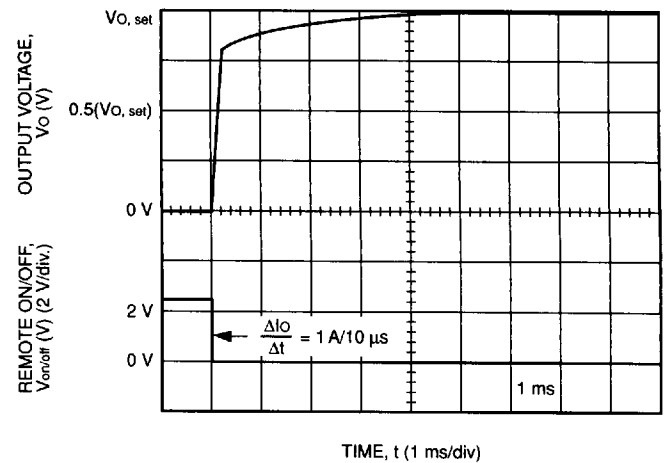

Figure 16. MW010A Typical Output Voltage Start-Up Waveform with Remote On/Off; $I_o = 0.8(I_{o,max})$; $V_I = 48\text{ V}$; $T_A = 25\text{ }^\circ\text{C}$

Characteristic Curves (continued)

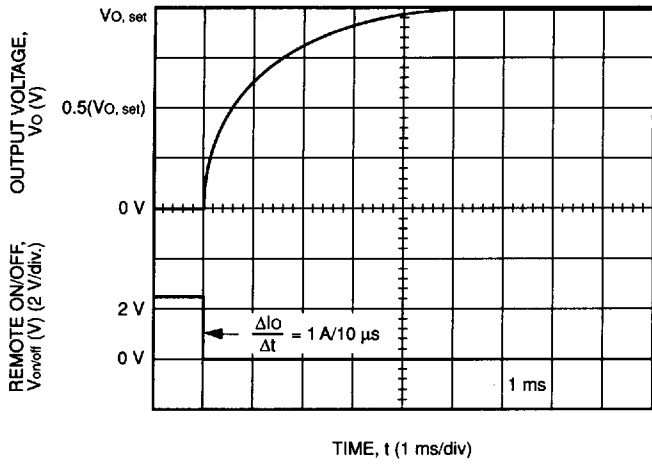

Figure 17. MW010B, C Typical Output Voltage Start-Up Waveform with Remote On/Off; $I_o = 0.8(I_{o, max})$; $V_I = 48 \text{ V}$; $T_A = 25 \text{ }^\circ\text{C}$

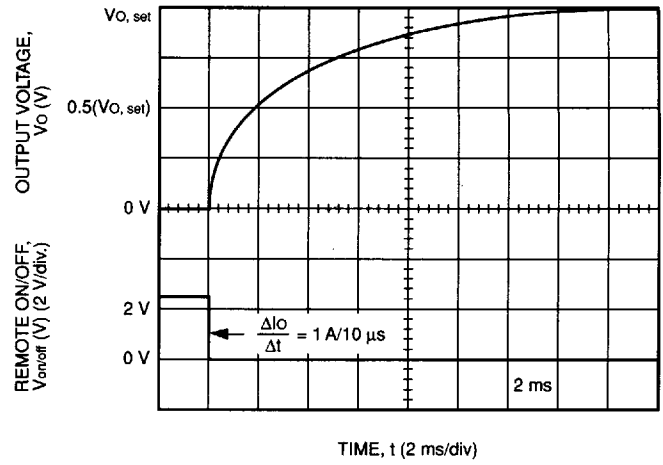
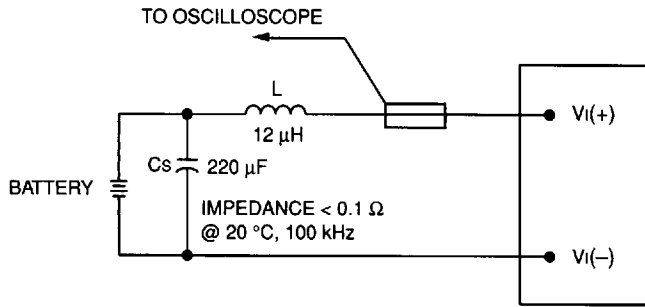

Figure 18. MW010BK, CL Typical Output Voltage Start-Up Waveform with Remote On/Off; $I_o = 0.8(I_{o, max})$; $V_I = 48 \text{ V}$; $T_A = 25 \text{ }^\circ\text{C}$

Test Configurations



Note: Input reflected-ripple current is measured with a simulated source impedance of 12 μH. Capacitor Cs offsets possible battery impedance. Current is measured at the input of the module.

Figure 19. Input Reflected-Ripple Test Setup

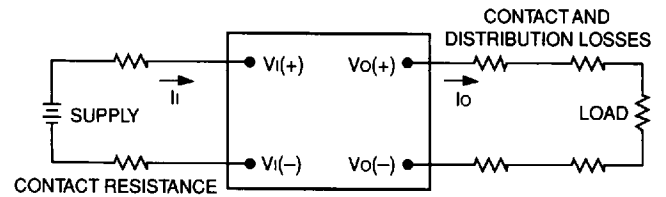

Note: All measurements are taken at the module terminals. When socketing, place Kelvin connections at module terminals to avoid measurement errors due to socket contact resistance.

$$\eta = \frac{[V_{O(+)} - V_{O(-)}] I_o}{[V_{I(+)} - V_{I(-)}] I_i}$$

Figure 21. MW010A, B, C Output Voltage and Efficiency Measurement Test Setup

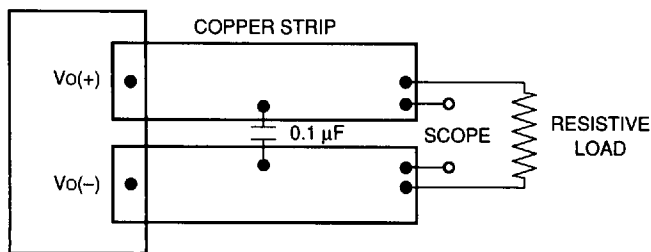

Note: Use a 0.1 μF ceramic capacitor. Scope measurement should be made using a BNC socket. Position the load between 2 in. and 3 in. from the module.

Figure 20. Peak-to-Peak Output Noise Measurement Test Setup

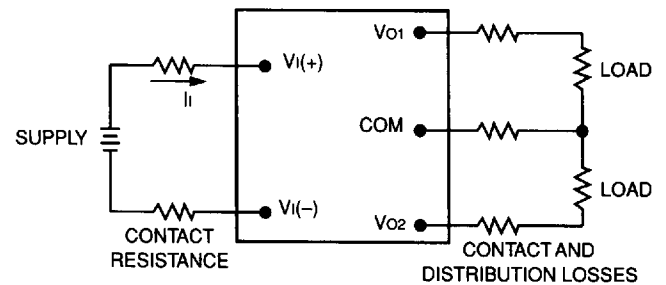

Note: All measurements are taken at the module terminals. When socketing, place Kelvin connections at module terminals to avoid measurement errors due to socket contact resistance.

$$\eta = \frac{\sum_{j=1}^2 | [V_{Oj(+)} - V_{COM}] I_{Oj} |}{[V_{I(+)} - V_{I(-)}] I_i}$$

Figure 22. MW010BK, CL Output Voltage and Efficiency Measurement Test Setup

Feature Descriptions

Output Overvoltage Clamp

The output overvoltage clamp consists of control circuitry, which is independent of the primary regulation loop, that monitors the voltage on the output terminals. The control loop of the clamp has a set point that is higher than the set point of the primary loop (see Feature Specifications table). This provides a redundant voltage-control that reduces the risk of output overvoltage.

Current Limit

To provide protection in a fault (output overload) condition, the unit is equipped with internal current-limiting and can endure current limiting for an unlimited duration. At the point of current-limit inception, the unit shifts from voltage control to current control. If the output voltage is pulled very low during a severe fault, the current-limit circuit can exhibit either foldback or tailout characteristics (output-current decrease or increase). The unit operates normally once the output current is brought back into its specified range.

Remote On/Off

(MW010A1, B1, C1, BK1, and CL1 only)

To turn the power module on and off, the user must supply a switch to control the voltage between the on/off terminal and the $V_{I(-)}$ terminal ($V_{on/off}$). The switch can be an open collector or equivalent (see Figure 3). A logic low is $V_{on/off} = 0$ V to 1.2 V, during which the module is on. The maximum $I_{on/off}$ during a logic low is 1 mA. The switch should maintain a logic low voltage while sinking 1 mA.

During a logic high, the maximum $V_{on/off}$ generated by the power module is 18 V. The maximum allowable leakage current of the switch at $V_{on/off} = 18$ V is 50 μ A.

Note: A PWB trace between the on/off terminal and the $V_{I(-)}$ terminal can be used to override the remote on/off.

CAUTION: To avoid damaging the module or external circuitry, the $V_{I(-)}$ pin must be connected to the -48 V source before or simultaneously to connecting the on/off pin to the -48 V source (either directly or through the external on/off circuitry).

Design Considerations

Remote On/Off

(MW010A1, B1, C1, BK1, and CL1 only)

Either the user-supplied switch or the override jumper should be wired into the circuit via individual traces not common with the $V_{I(-)}$ power current path. Connect the switch or jumper at the power module terminals (see Figure 23). Configuring the switch connection in this way prevents noise from falsely triggering the remote on/off.

Top view.

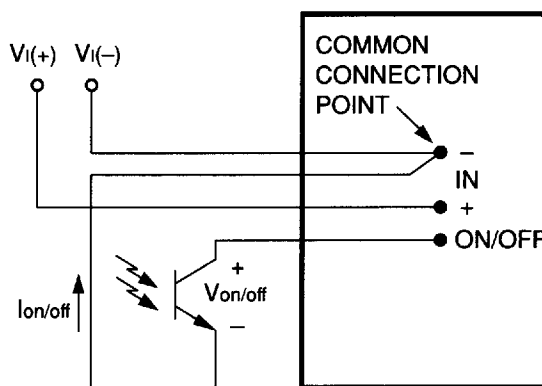

Figure 23. Remote On/Off Wiring Configuration

Input Filtering

An internal aluminum electrolytic capacitor is used for filtering; therefore, input ripple increases as temperature decreases. (There is approximately two times more ripple at 0 °C than at 25 °C and eight times more ripple at -40 °C than at 25 °C.) The power module functions properly down to -40 °C with no additional filtering. If needed, an external capacitor across the input with an impedance of 0.3 Ω at 100 kHz over the desired temperature range can be added to limit the input ripple current to the typical level given in the Input Specifications table.

Output Voltage Reversal

CAUTION: Applying a reverse voltage across the module output forward biases an internal diode. Attempting to start the module under this condition can damage the module.

Outline Diagrams

Dimensions are in inches and (millimeters).

Tolerances: x.xx ± 0.02 in. (0.5 mm), x.xxx ± 0.010 in. (0.25 mm).

Single-Output Module (MW010A, B, C)

Top View

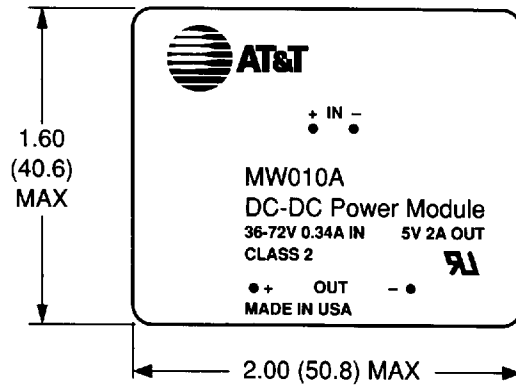

Side View

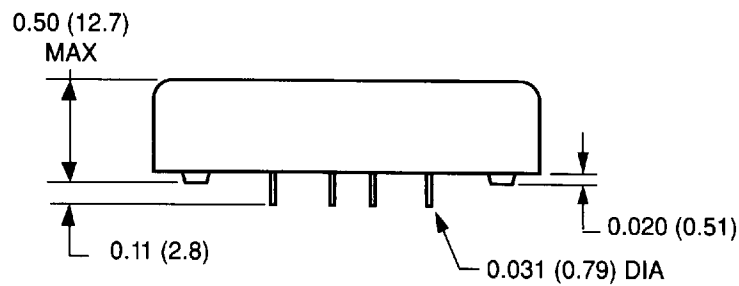

Bottom View

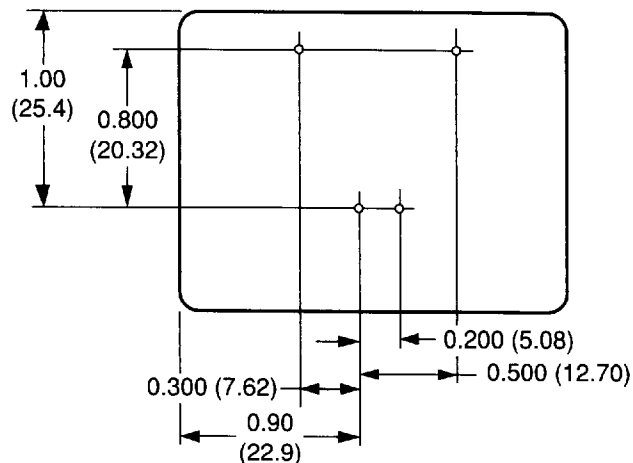

**MW010-Series Power Modules:
36 Vdc to 72 Vdc Inputs; 10 W**

Outline Diagrams (continued)

Dimensions are in inches and (millimeters).

Tolerances: $x.xx \pm 0.02$ in. (0.5 mm), $x.xxx \pm 0.010$ in. (0.25 mm).

Single-Output Module with Remote On/Off (MW010A1, B1, C1)

Top View

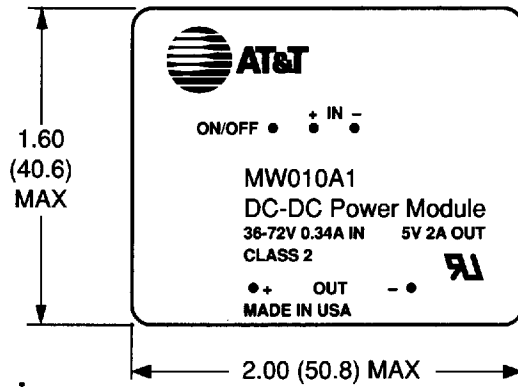

Side View

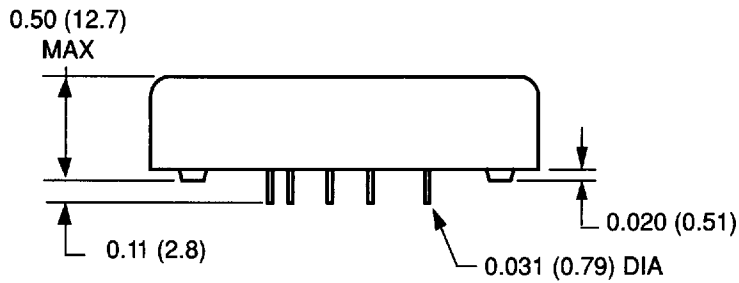

Bottom View

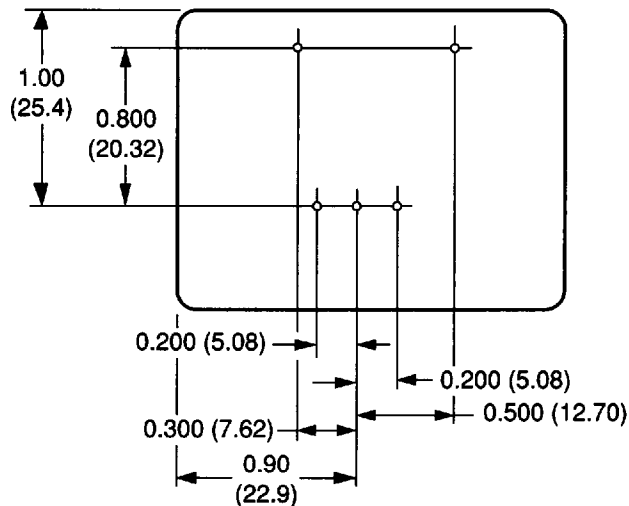

Outline Diagrams (continued)

Dimensions are in inches and (millimeters).

Tolerances: x.xx ± 0.02 in. (0.5 mm), x.xxx ± 0.010 in. (0.25 mm).

Dual-Output Module (MW010BK, CL)

Top View

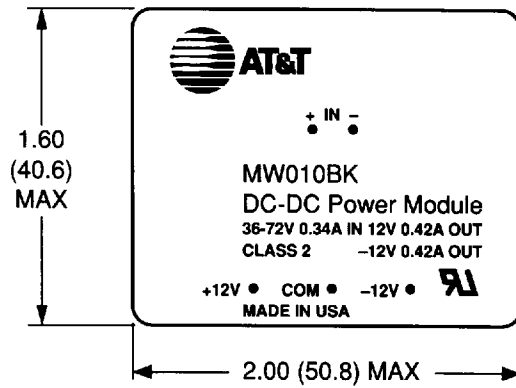

Side View

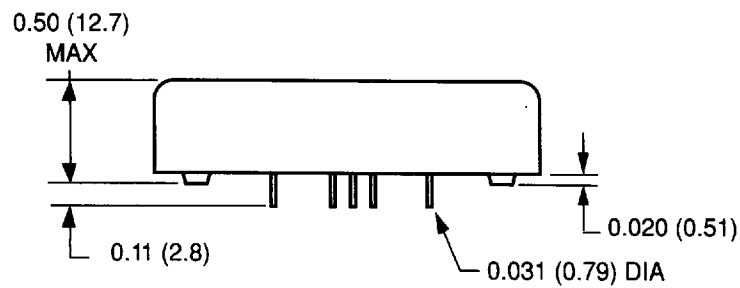

Bottom View

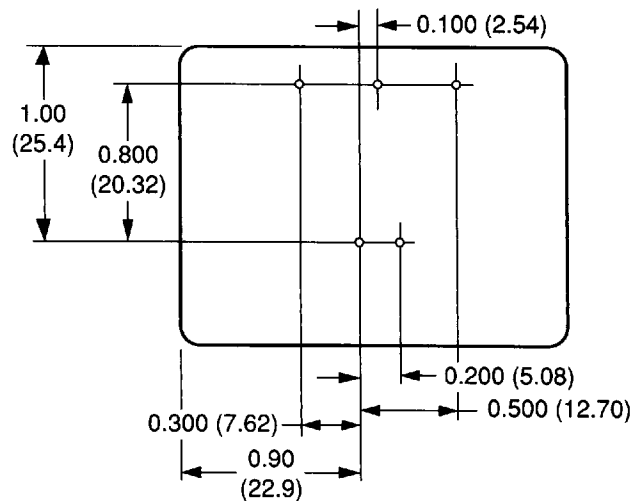

**MW010-Series Power Modules:
36 Vdc to 72 Vdc Inputs; 10 W**

Outline Diagrams (continued)

Dimensions are in inches and (millimeters).

Tolerances: x.xx ± 0.02 in. (0.5 mm), x.xxx ± 0.010 in. (0.25 mm).

Dual-Output Module with Remote On/Off (MW010BK1, CL1)

Top View

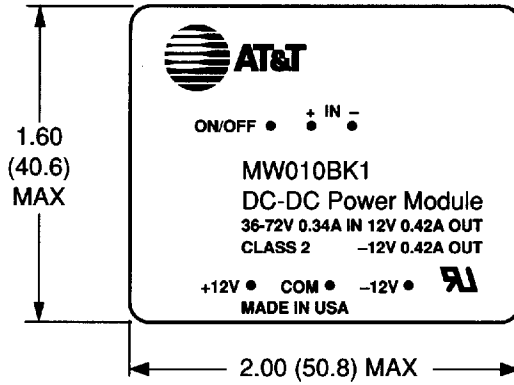

Side View

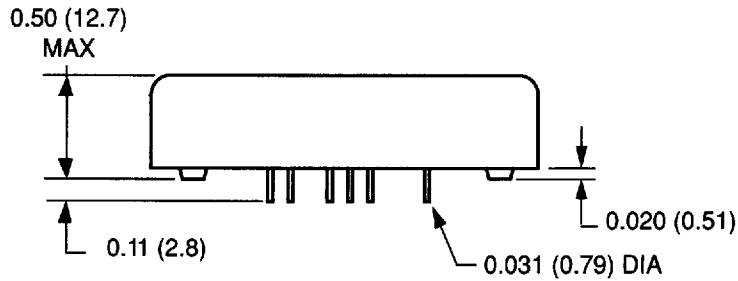

Bottom View

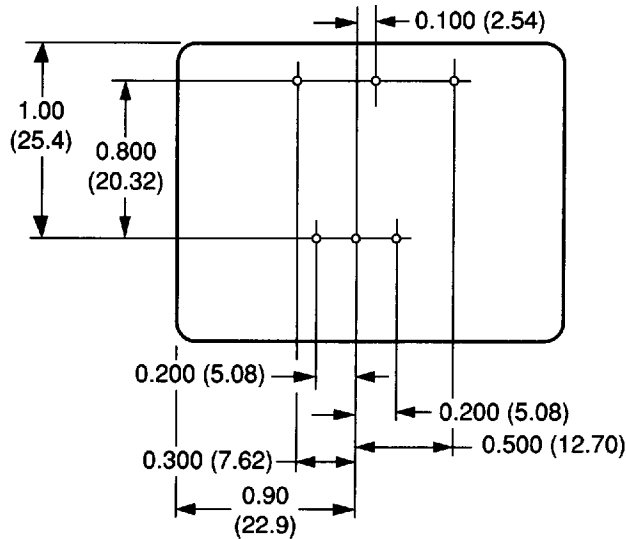

Recommended Hole Patterns

Dimensions are in inches and (millimeters).

Single-Output Module (MW010A, B, C)

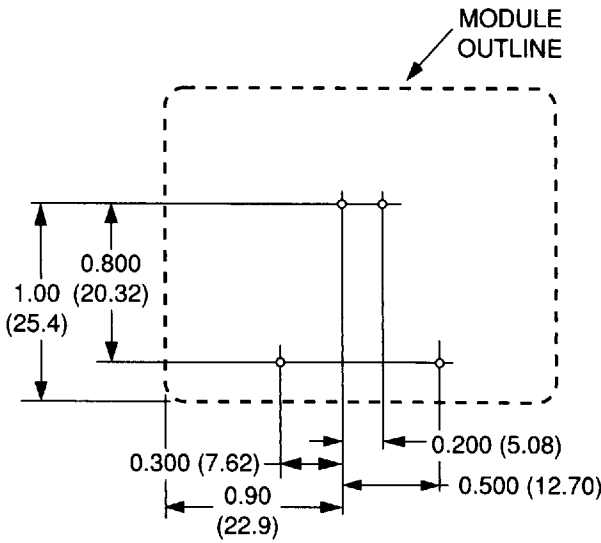

Single-Output Module with Remote On/Off (MW010A1, B1, C1)

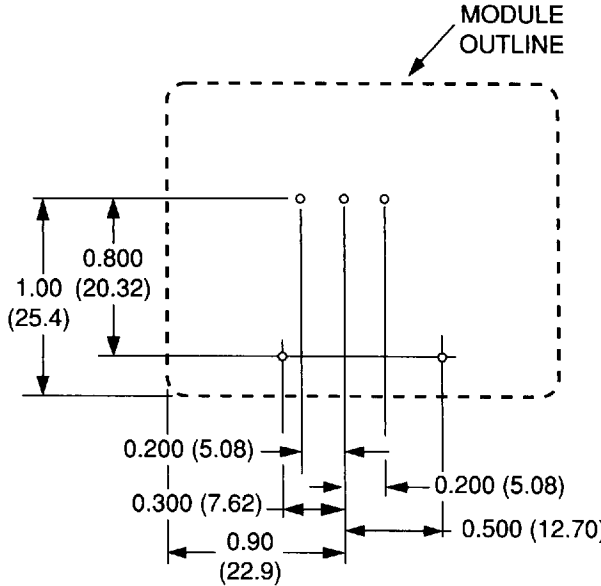

**MW010-Series Power Modules:
36 Vdc to 72 Vdc Inputs; 10 W**

Recommended Hole Patterns (continued)

Dimensions are in inches and (millimeters).

Dual-Output Module (MW010BK, CL)

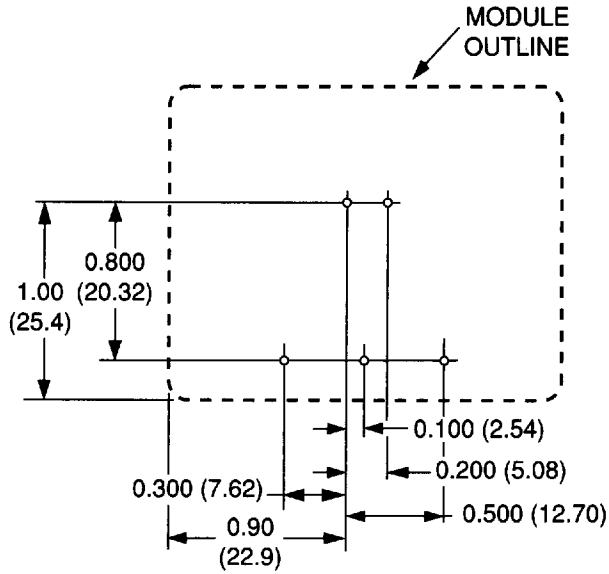

Dual-Output Module with Remote On/Off (MW010BK1, CL1)

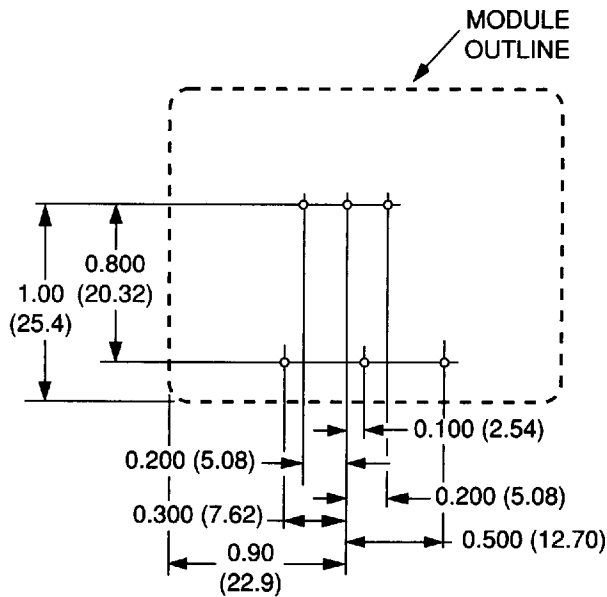

Ordering Information

Input Voltage	Output Voltage	Remote On/Off	Device Code	Comcode
36 V—72 V	5.0	no	MW010A	106233950
36 V—72 V	5.0	yes	MW010A1	106233968
36 V—72 V	12.0	no	MW010B	106233976
36 V—72 V	12.0	yes	MW010B1	106233984
36 V—72 V	15.0	no	MW010C	106233992
36 V—72 V	15.0	yes	MW010C1	106234008
36 V—72 V	+12 V, -12 V	no	MW010BK	106467293
36 V—72 V	+12 V, -12 V	yes	MW010BK1	106467319
36 V—72 V	+15 V, -15 V	no	MW010CL	106467327
36 V—72 V	+15 V, -15 V	yes	MW010CL1	106467335