



Not Intended For New Designs

T-46-07-08

# 100130 Triple D Latch

## General Description

The 100130 contains three D-type latches with true and complement outputs and with Common Enable ( $E_C$ ), Master Set (MS) and Master Reset (MR) inputs. Each latch has its own Enable ( $E_n$ ), Direct Set ( $SD_n$ ) and Direct Clear ( $CD_n$ ) inputs. The Q output follows its Data (D) input when both  $E_n$  and  $E_C$  are LOW (transparent mode). When either  $E_n$  or  $E_C$

(or both) are HIGH, a latch stores the last valid data present on its  $D_n$  input before  $E_n$  or  $E_C$  goes HIGH.

Both Master Reset (MR) and Master Set (MS) inputs override the Enable inputs. The individual  $CD_n$  and  $SD_n$  also override the Enable inputs. All inputs have 50 k $\Omega$  pull-down resistors.

**Ordering Code:** See Section 6

## Logic Symbol

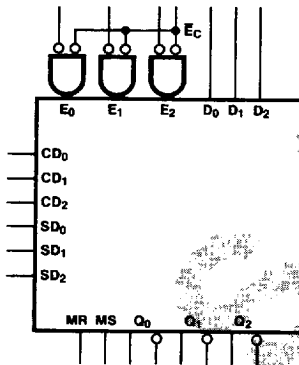

Pin Names	Description
$CD_0$ – $CD_2$	Individual Direct Clear Inputs
$SD_0$ – $SD_2$	Individual Direct Set Inputs
$E_0$ – $E_2$	Individual Enable Inputs (Active LOW)
$\bar{E}_C$	Common Enable Input (Active LOW)
$D_0$ – $D_2$	Data Inputs
MR	Master Reset Input
MS	Master Set Input
$Q_0$ – $Q_2$	Data Outputs
$\bar{Q}_0$ – $\bar{Q}_2$	Complementary Data Outputs

TL/F/9852-3

## Connection Diagrams

24-Pin DIP

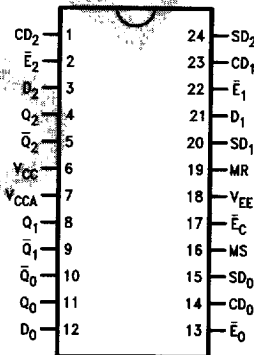

TL/F/9852-1

24-Pin Quad Cerpak

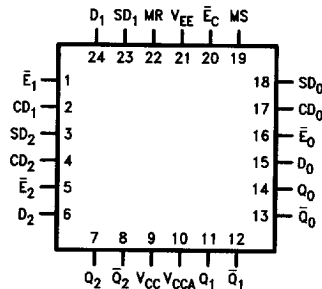

TL/F/9852-2

100130

### Logic Diagram

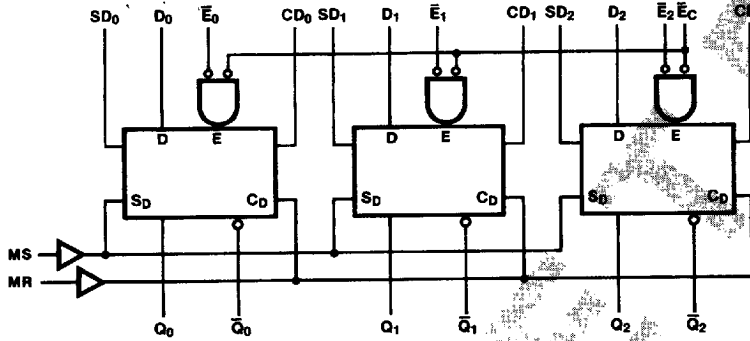

TL/F/9852-5

### Truth Tables (Each Latch)

Latch Operation

Inputs					Outputs
$D_n$	$\bar{E}_n$	$\bar{E}_C$	MS $SD_n$	MR $CD_n$	$Q_n$
L	L	L	L	L	L
H	L	L	L	L	H
X	H	X	L	L	Latched*
X	X	H	L	L	Latched*

Asynchronous Operation

Inputs					Outputs
$D_n$	$\bar{E}_n$	$\bar{E}_C$	MS $SD_n$	MR $CD_n$	$Q_n$
X	X	X	H	L	H
X	X	X	L	H	L
X	X	X	H	H	U

\*Retains data presented before  $\bar{E}$  positive transition

H = HIGH Voltage Level

L = LOW Voltage Level

X = Don't Care

U = Undefined

100130

### Absolute Maximum Ratings

Above which the useful life may be impaired. (Note 1)

If Military/Aerospace specified devices are required, please contact the National Semiconductor Sales Office/Distributors for availability and specifications.

Storage Temperature -65°C to +150°C  
 Maximum Junction Temperature (T<sub>J</sub>) +150°C

Case Temperature under Bias (T<sub>C</sub>) 0°C to +85°C  
 V<sub>EE</sub> Pin Potential to Ground Pin -7.0V to +0.5V  
 Input Voltage (DC) V<sub>EE</sub> to +0.5V  
 Output Current (DC Output HIGH) -50 mA  
 Operating Range (Note 2) -5.7V to -4.2V

### DC Electrical Characteristics

V<sub>EE</sub> = -4.5V, V<sub>CC</sub> = V<sub>CCA</sub> = GND, T<sub>C</sub> = 0°C to +85°C (Note 3)

Symbol	Parameter	Min	Typ	Max	Units	Conditions (Note 4)	
V <sub>OH</sub>	Output HIGH Voltage	-1025	-955	-880	mV	V <sub>IN</sub> = V <sub>IH</sub> (Max) or V <sub>IL</sub> (Min)	Loading with 50Ω to -2.0V
V <sub>OL</sub>	Output LOW Voltage	-1810	-1705	-1620			
V <sub>OHC</sub>	Output HIGH Voltage	-1035			mV	V <sub>IN</sub> = V <sub>IH</sub> (Min) or V <sub>IL</sub> (Max)	Loading with 50Ω to -2.0V
V <sub>OLC</sub>	Output LOW Voltage			-1610			
V <sub>IH</sub>	Input HIGH Voltage	-1165		-880	mV	Guaranteed HIGH Signal for All Inputs	
V <sub>IL</sub>	Input LOW Voltage	-1810		-1475	mV	Guaranteed LOW Signal for All Inputs	
I <sub>IL</sub>	Input LOW Current	0.50			μA	V <sub>IN</sub> = V <sub>IL</sub> (Min)	

### DC Electrical Characteristics

V<sub>EE</sub> = -4.2V, V<sub>CC</sub> = V<sub>CCA</sub> = GND, T<sub>C</sub> = 0°C to +85°C (Note 3)

Symbol	Parameter	Min	Typ	Max	Units	Conditions (Note 4)	
V <sub>OH</sub>	Output HIGH Voltage	-1020		-870	mV	V <sub>IN</sub> = V <sub>IH</sub> (Max) or V <sub>IL</sub> (Min)	Loading with 50Ω to -2.0V
V <sub>OL</sub>	Output LOW Voltage	-1810		-1605			
V <sub>OHC</sub>	Output HIGH Voltage	-1030			mV	V <sub>IN</sub> = V <sub>IH</sub> (Min) or V <sub>IL</sub> (Max)	Loading with 50Ω to -2.0V
V <sub>OLC</sub>	Output LOW Voltage			-1595			
V <sub>IH</sub>	Input HIGH Voltage	-1150		-870	mV	Guaranteed HIGH Signal for All Inputs	
V <sub>IL</sub>	Input LOW Voltage	-1810		-1475	mV	Guaranteed LOW Signal for All Inputs	
I <sub>IL</sub>	Input LOW Current	0.50			μA	V <sub>IN</sub> = V <sub>IL</sub> (Min)	

### DC Electrical Characteristics

V<sub>EE</sub> = -4.8V, V<sub>CC</sub> = V<sub>CCA</sub> = GND, T<sub>C</sub> = 0°C to +85°C (Note 3)

Symbol	Parameter	Min	Typ	Max	Units	Conditions (Note 4)	
V <sub>OH</sub>	Output HIGH Voltage	-1035		-880	mV	V <sub>IN</sub> = V <sub>IH</sub> (Max) or V <sub>IL</sub> (Min)	Loading with 50Ω to -2.0V
V <sub>OL</sub>	Output LOW Voltage	-1830		-1620			
V <sub>OHC</sub>	Output HIGH Voltage	-1045			mV	V <sub>IN</sub> = V <sub>IH</sub> (Min) or V <sub>IL</sub> (Max)	Loading with 50Ω to -2.0V
V <sub>OLC</sub>	Output LOW Voltage			-1610			
V <sub>IH</sub>	Input HIGH Voltage	-1165		-880	mV	Guaranteed HIGH Signal for All Inputs	
V <sub>IL</sub>	Input LOW Voltage	-1830		-1490	mV	Guaranteed LOW Signal for All Inputs	
I <sub>IL</sub>	Input LOW Current	0.50			μA	V <sub>IN</sub> = V <sub>IL</sub> (Min)	

**Note 1:** Absolute maximum ratings are those values beyond which the device may be damaged or have its useful life impaired. Functional operation under these conditions is not implied.

**Note 2:** Parametric values specified at -4.2V to -4.8V.

**Note 3:** The specified limits represent the "worst case" value for the parameter. Since these "worst case" values normally occur at the temperature extremes, additional noise immunity and guard banding can be achieved by decreasing the allowable system operating ranges.

**Note 4:** Conditions for testing shown in the tables are chosen to guarantee operation under "worst case" conditions.

3

100130

**DC Electrical Characteristics**

$V_{EE} = -4.2V$  to  $-4.8V$  unless otherwise specified,  $V_{CC} = V_{CCA} = GND$ ,  $T_C = 0^\circ C$  to  $+85^\circ C$

Symbol	Parameter	Min	Typ	Max	Units	Conditions
$I_{IH}$	Input HIGH Current			350	$\mu A$	$V_{in} = V_{IH} (Max)$
	$D_n$			530		
	$CD_n, SD_n$			240		
	$E_n$			450		
$I_{EE}$	Power Supply Current	-149	-106	-74	$mA$	Inputs Open

**Ceramic Dual-In-Line Package AC Electrical Characteristics**

$V_{EE} = -4.2V$  to  $-4.8V$ ,  $V_{CC} = V_{CCA} = GND$

Symbol	Parameter	$T_C = 0^\circ C$		$T_C = +25^\circ C$		$T_C = +85^\circ C$		Units	Conditions
		Min	Max	Min	Max	Min	Max		
$t_{PLH}$ $t_{PHL}$	Propagation Delay $D_n$ to Output (Transparent Mode)	0.50	1.80	0.50	1.70	0.50	1.90	ns	Figures 1 and 2
$t_{PLH}$ $t_{PHL}$	Propagation Delay $E_C$ to Output	0.65	2.10	0.75	2.00	0.75	2.10	ns	
$t_{PLH}$ $t_{PHL}$	Propagation Delay $CD_n, SD_n, E_n$ to Output	0.50	2.00	0.60	1.75	0.60	2.00	ns	Figures 1, 2 and 3
$t_{PLH}$ $t_{PHL}$	Propagation Delay MS, MR to Output	1.10	2.50	1.10	2.40	1.10	2.60	ns	Figures 1 and 2
$t_{TLH}$ $t_{THL}$	Transition Time 20% to 80%, 80% to 20%	0.45	1.60	0.45	1.60	0.45	1.60	ns	Figures 1 and 2
$t_s$	Setup Time $D_0-D_2$	0.90		0.70		0.90		ns	Figures 3 and 4
	$CD_n, SD_n$ (Release Time)	1.20		1.10		1.40			
	MR, MS (Release Time)	1.90		1.90		2.00			
$t_h$	Hold Time $D_0-D_2$	0.60		0.60		0.80		ns	Figure 4
$t_{pw(L)}$	Pulse Width LOW $E_n, E_C$	2.00		2.00		2.00		ns	Figure 2
$t_{pw(H)}$	Pulse Width HIGH $CD_n, SD_n, MR, MS$	2.00		2.00		2.00		ns	Figure 3

### Cerpak AC Electrical Characteristics $V_{EE} = -4.2V$ to $-4.8V$ , $V_{CC} = V_{CCA} = GND$

Symbol	Parameter	$T_C = 0^\circ C$		$T_C = +25^\circ C$		$T_C = +85^\circ C$		Units	Conditions
		Min	Max	Min	Max	Min	Max		
$t_{PLH}$ $t_{PHL}$	Propagation Delay $D_n$ to Output (Transparent Mode)	0.50	1.60	0.50	1.50	0.50	1.70	ns	Figures 1 and 2
$t_{PLH}$ $t_{PHL}$	Propagation Delay $\bar{E}_C$ to Output	0.65	1.90	0.75	1.80	0.75	1.90	ns	
$t_{PLH}$ $t_{PHL}$	Propagation Delay $CD_n, SD_n, \bar{E}_n$ to Output	0.50	1.80	0.60	1.55	0.60	1.80	ns	Figures 1, 2 and 3
$t_{PLH}$ $t_{PHL}$	Propagation Delay MS, MR to Output	1.10	2.30	1.10	2.20	1.10	2.40	ns	Figures 1 and 3
$t_{TLH}$ $t_{THL}$	Transition Time 20% to 80%, 80% to 20%	0.45	1.50	0.45	1.50	0.45	1.50	ns	Figures 1 and 2
$t_s$	Setup Time $D_0-D_2$	0.80		0.60		0.60		ns	Figures 3 and 4
	$CD_n, SD_n$ (Release Time)	1.10		1.00		1.30			
	MR, MS (Release Time)	1.80		1.80		2.00			
$t_h$	Hold Time $D_0-D_2$	0.50		0.50		0.70		ns	Figure 4
$t_{pw(L)}$	Pulse Width LOW $\bar{E}_n, \bar{E}_C$	2.00		2.00		2.00		ns	Figure 2
$t_{pw(H)}$	Pulse Width HIGH $CD_n, SD_n, MR, MS$	2.00		2.00		2.00		ns	Figure 3

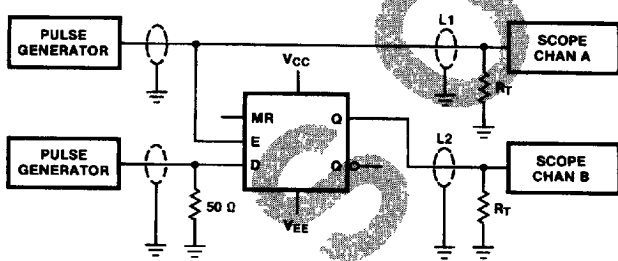

**Notes:**  
 $V_{CC}, V_{CCA} = +2V$ ,  $V_{EE} = -2.5V$   
 L1 and L2 = equal length 50Ω impedance lines  
 $R_T = 50\Omega$  terminator internal to scope  
 Decoupling 0.1  $\mu F$  from GND to  $V_{CC}$  and  $V_{EE}$   
 All unused outputs are loaded with 50Ω to GND  
 $C_L =$  Fixture and stray capacitance  $\leq 3 pF$

TL/F/9852-6  
**FIGURE 1. AC Test Circuit**

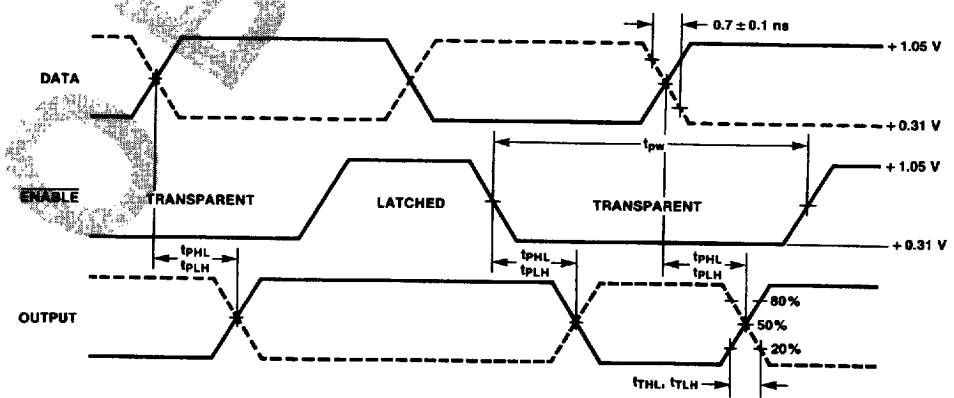

TL/F/9852-7  
**FIGURE 2. Enable Timing**

100130

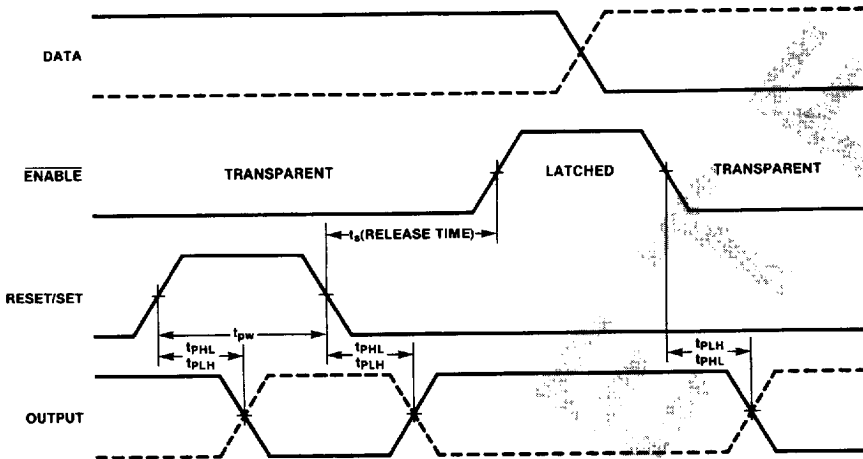

TL/F/8852-8

FIGURE 3. Reset Timing

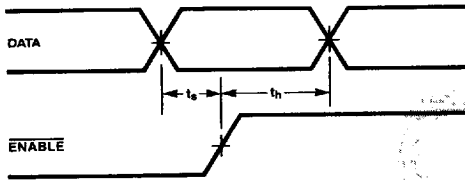

Notes:

- $t_s$  is the minimum time before the transition of the enable that information must be present at the data input.
- $t_h$  is the minimum time after the transition of the enable that information must remain unchanged at the data input.

TL/F/8852-9

FIGURE 4. Data Setup and Hold Time