

# Standalone Linear Li-Ion Battery Charger with Thermal Regulation in SOT-25

## General Description

The EMC5754 is a complete linear charger for single cell lithium-ion batteries. With small SOT-25 package and few external components, EMC5754 is well suited for portable applications. In addition, the EMC5754 is specifically designed to work within USB power specifications.

No external sense resistor and blocking diode are required. Charging current can be programmed externally with a single resistor. The built-in thermal regulation facilitates charging with maximum power without risk of overheating.

The EMC5754 always preconditions the battery with 1/10 of the programmed charge current at the beginning of a charge cycle, until 40 $\mu$ s after it verifies that the battery can be fast-charged. The EMC5754 automatically terminates the charge cycle when the charge current drops to 1/10th the programmed value after the final float voltage is reached.

The EMC5754 consumes zero reverse current from the battery at standby, shutdown and sleep modes. This feature reduces the charge and discharge cycles on the battery, further prolonging the battery life. The EMC5754 can also be used as a LDO when battery is removed. Other features include shutdown mode, charge current monitor, under voltage lockout, automatic recharge and status indicator.

## Features

- Programmable charge current up to 1A
- No MOSFET, sense resistor or blocking diode required
- Complete linear charger in SOT-25 for single cell Lithium-ion batteries
- **Typical zero reverse current from battery**
- Thermal regulation maximizes charge rate without risk of overheating
- Charges single cell Li-ion batteries directly from USB port
- Act as a LDO when battery is removed
- Preset 4.2V charge voltage with  $\pm 1\%$  accuracy
- Automatic recharge
- Charge status indicator
- C/10 charge termination
- 45 $\mu$ A shutdown supply current
- 2.9V trickle charge threshold
- Soft-start limits inrush current
- RoHS compliant and Pb-free

## Applications

- Wireless handsets
- Hand-held instruments
- Portable information appliances
- Bluetooth application
- Charging docks and cradles

## Typical Application Diagram

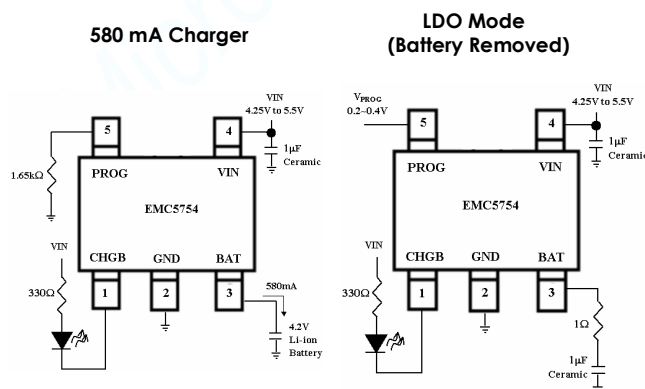

## Typical Performance Characteristics

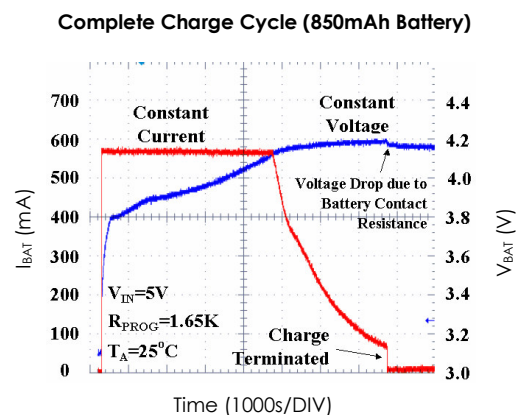

Elite MicroPower Inc. reserves the right to make changes to improve reliability or manufacturability without notice, and customers are advised to obtain the latest version of relevant information prior to placing orders

**Pin Configuration  
SOT-25(Top View)**

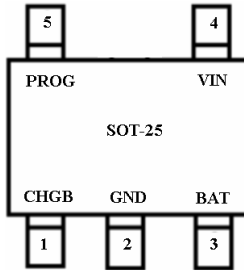

**Order information**

EMC5754--00VF05GRR

- 00 Operation
- VF05 SOT-25 Package
- GRR RoHS package
- Commercial Grade Temperature
- Rating: -40 to 85°C
- Package in Tape & Reel

**Marking & Packing Information**

Package Type	Marking	Product ID	Transport Media
SOT-25		EMC5754-00VF05GRR	3K units Tape & Reel

## Pin Functions

Name	SOT-25	Function
CHGB	1	Open-Drain Charge Status Output. An internal N-channel MOSFET connects CHGB pin to ground when the battery is charging. After the charge cycle is completed, the internal N-channel MOSFET is replaced by a weak pull-down of approximately 24μA, indicating an "AC present" condition. When the EMC5754 detects an under voltage lockout condition, CHGB is forced high impedance.
GND	2	Ground
BAT	3	Charge Current Output and battery voltage feedback. This pin provides charge current to the battery and regulates the final float voltage to 4.2V. An internal precision resistor divider from this pin sets the float voltage which is disconnected in standby, shutdown and sleep modes.
VIN	4	Positive Input Supply Voltage. Provides power to the charger. VIN can range from 4.25V to 5.5V and should be bypassed with at least a 1μF capacitor. When VIN drops to within 30mV above the BAT pin voltage, the EMC5754 enters shutdown mode, dropping IBAT to less than 1μA.
PROG	5	Charge Current Program, Charge Current Monitor and Shutdown Pin. The charge current is programmed by connecting a 1% resistor, R <sub>PROG</sub> , to ground. When charging in constant-current mode, this pin serves to 1V. In all modes, the voltage on this pin can be used to measure the charge current using the following formula: $I_{BAT} = (V_{PROG} / R_{PROG}) * 960$ The PROG pin can also be used to shut down the charger. Disconnecting the program resistor from ground allows a 0.4μA current to pull the PROG pin high. When it reaches the 1.18V shutdown threshold voltage, the charger enters shutdown mode. This pin is also clamped to approximately 2.4V. Reconnecting R <sub>PROG</sub> to ground will return the charger to normal operation. Connecting the PROG pin to a voltage between 0.2V and 0.4V can force EMC5754 into LDO mode. <b>The PROG pin must not be directly shorted to ground at any condition.</b>

www.DataSheet4U.com

Elite MicroPower Inc. reserves the right to make changes to improve reliability or manufacturability without notice, and customers are advised to obtain the latest version of relevant information prior to placing orders

## Absolute Maximum Ratings (Notes 1, 2)

V <sub>IN</sub> , V <sub>BAT</sub> , V <sub>CHGB</sub>	-0.3V to 6.0V	Junction Temperature (T <sub>J</sub> )	150°C
V <sub>PROG</sub>	(Note 3) -0.3V to VIN +0.3V	Lead Temperature (10 sec.)	260°C
BAT Short-Circuit Duration	Continuous	Thermal Resistance (θ <sub>JA</sub> )	
BAT Pin Current	1A	SOT-25	(Note 5)
PROG Pin Current	1mA		
Storage Temperature Range	-65°C to 160°C		

## Operating Ratings

Temperature Range	-40°C to 85°C
Supply Voltage	4.25V to 5.5V

**Note: Devices are ESD sensitive. The leads should be shorted together or the device placed in conductive foam during storage or handling to prevent electrostatic damage to the device.**

## Electrical Characteristics

Unless otherwise specified, T<sub>A</sub>=25°C and V<sub>IN</sub>=5V.

Symbol	Parameter	Conditions	Min	Typ	Max	Units
V <sub>IN</sub>	Input Voltage		4.25		5.5	V
I <sub>CC</sub>	Input Supply Current	Charge Mode, R <sub>PROG</sub> =10K (Note 4)	150	260	330	μA
		Standby Mode (Charge Terminated)	50	106	150	μA
		Shutdown Mode (R <sub>PROG</sub> Not Connected, V <sub>IN</sub> <V <sub>BAT</sub> or V <sub>IN</sub> <V <sub>UV</sub> )	20	45	75	μA
V <sub>FLOAT</sub>	Regulated Output (Float) Voltage	0°C ≤ T <sub>A</sub> ≤ 85°C	4.158	4.2	4.242	V
I <sub>BAT</sub>	BAT Pin Current	R <sub>PROG</sub> =2K, Current Mode	447	480	513	mA
		Standby Mode, V <sub>BAT</sub> =4.2V	-1	0	1	μA
		Shutdown Mode (R <sub>PROG</sub> Not Connected)	-1	0	1	μA
		Sleep Mode, V <sub>IN</sub> =0V	-1	0	1	μA
I <sub>TRICKLE</sub>	Trickle Charge Current	V <sub>BAT</sub> <V <sub>TRICKLE</sub> , R <sub>PROG</sub> =2K	21	50	66	mA
V <sub>TRICKLE</sub>	Trickle Charge Threshold Voltage	R <sub>PROG</sub> =10K, V <sub>BAT</sub> Rising	2.8	2.9	3.0	V
V <sub>TRHYS</sub>	Trickle Charge Hysteresis Voltage	R <sub>PROG</sub> =10K		210		mV
V <sub>UV</sub>	V <sub>IN</sub> Under voltage Lockout Threshold	From V <sub>IN</sub> Low to High	2.45	3.0	3.75	V
V <sub>UVHYS</sub>	V <sub>IN</sub> Under voltage Lockout Hysteresis			180		mV
V <sub>MSD</sub>	Manual Shutdown Threshold Voltage	PROG Pin Rising		1.18	1.25	V
		PROG Pin Falling	1.00	1.04		V
V <sub>ASD</sub>	V <sub>IN</sub> -V <sub>BAT</sub> Lockout Threshold Voltage	V <sub>IN</sub> from Low to High		80	140	mV
		V <sub>IN</sub> from High to Low	5	30		mV
I <sub>TERM</sub>	C/10 Termination Current Threshold	R <sub>PROG</sub> =10K		0.1		mA/mA
V <sub>PROG</sub>	PROG Pin Voltage	R <sub>PROG</sub> =10K, Current Mode	0.93	1.0	1.07	V
I <sub>CHGB</sub>	CHGB Pin Weak Pull-Down Current	V <sub>CHGB</sub> =5V		24		μA

*Elite MicroPower Inc. reserves the right to make changes to improve reliability or manufacturability without notice, and customers are advised to obtain the latest version of relevant information prior to placing orders*

V <sub>CHGB</sub>	CHGB Pin Output Low Voltage	I <sub>CHGB</sub> = 5mA		0.23	0.6	V
V <sub>RECHRG</sub>	Recharge Battery Threshold Voltage	V <sub>Float</sub> - V <sub>RECHRG</sub>		160		mV
T <sub>ILM</sub>	Junction Temperature in Constant Temperature Mode			120		°C
R <sub>ON</sub>	Power FET "ON" Resistance			550		mΩ
T <sub>SS</sub>	Soft-Start Time	I <sub>BAT</sub> = 0 to I <sub>BAT</sub> = 960V/R <sub>PROG</sub>		100		μs
T <sub>RECHARGE</sub>	Recharge Comparator Filter Time	V <sub>BAT</sub> High to Low	0.75	2.4	4.5	ms
T <sub>TERM</sub>	Termination Comparator Filter Time	I <sub>BAT</sub> Falling Below I <sub>CHG</sub> /10	0.4	1.1	2.5	ms
I <sub>PROG</sub>	PROG Pin Pull-up Current			0.4		μA

**Note 1:** Absolute Maximum ratings indicate limits beyond which damage may occur. Electrical specifications are not applicable when the device is operated outside of its rated operating conditions.

**Note 2:** All voltages are defined and measured with respect to the potential at the ground pin.

**Note 3:** Can not exceed 6.0V.

**Note 4:** Supply current includes PROG pin current (approximately 100μA) but does not include any current delivered to the battery through the BAT pin (approximately 96mA).

**Note 5:** 80°C/W to 150°C/W, depending on PCB Layout.

### Functional Block Diagram

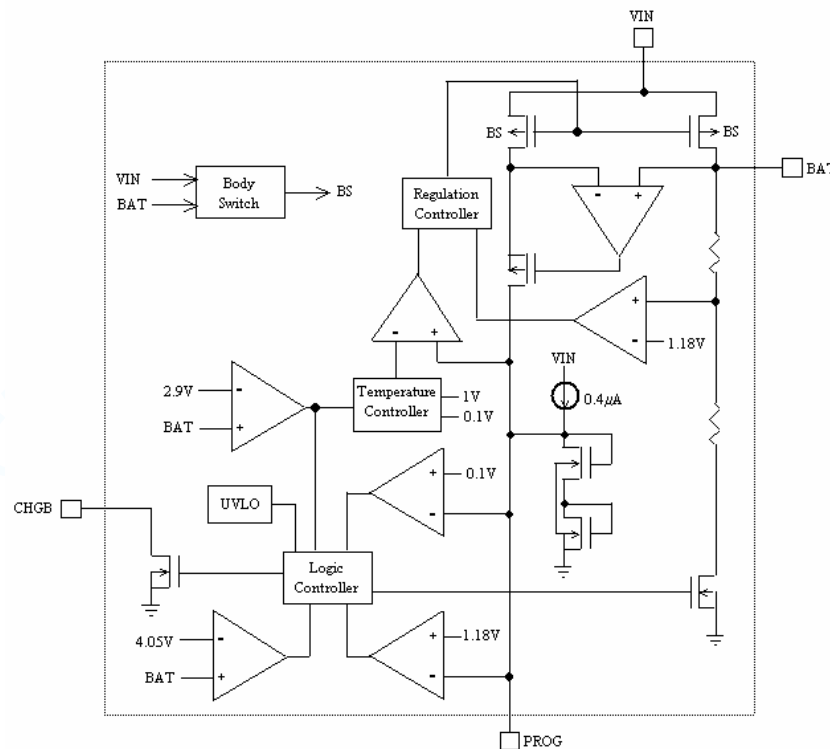

Elite MicroPower Inc. reserves the right to make changes to improve reliability or manufacturability without notice, and customers are advised to obtain the latest version of relevant information prior to placing orders

**State Diagram**

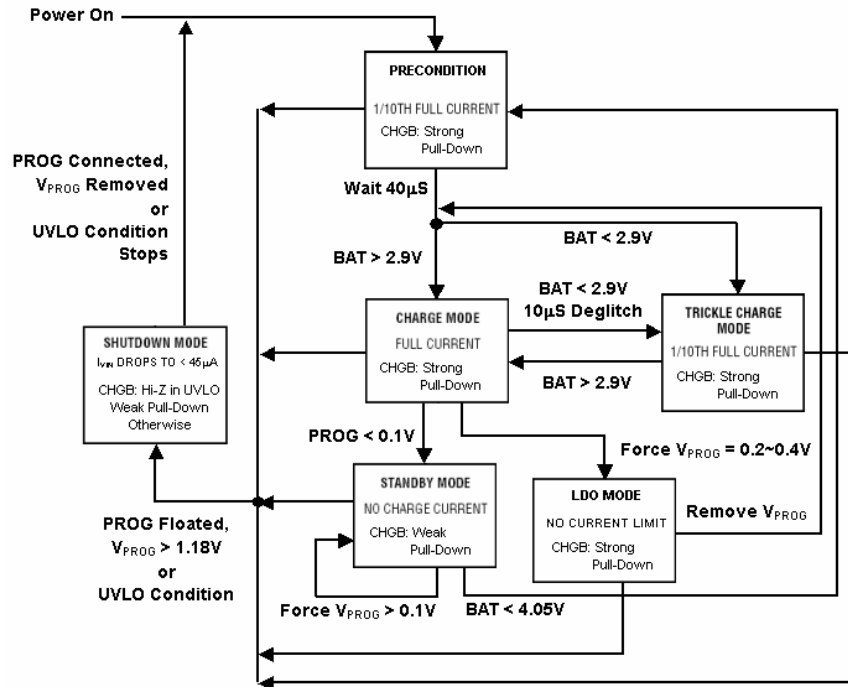

**Typical Applications**

**USB/Wall Adapter Power Li-ion Charger**

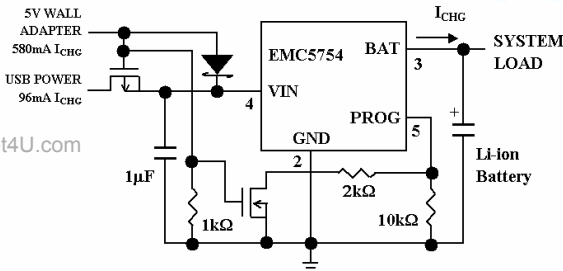

**Full Featured Single Cell Li-ion Charger**

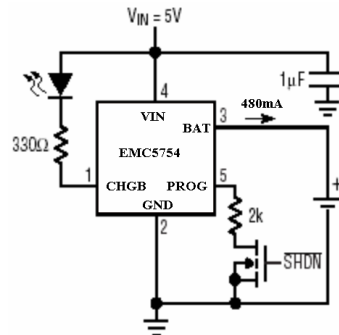

**Li-ion Charger with External Power Dissipation**

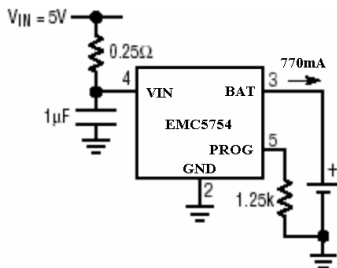

**Basic Li-ion Charger with Reverse Polarity Input Protection**

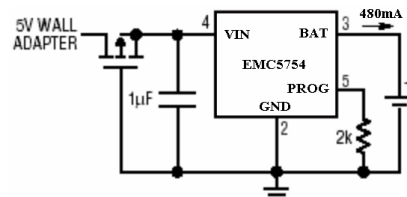

Elite MicroPower Inc. reserves the right to make changes to improve reliability or manufacturability without notice, and customers are advised to obtain the latest version of relevant information prior to placing orders

Turn off the LED after Charge is Terminated

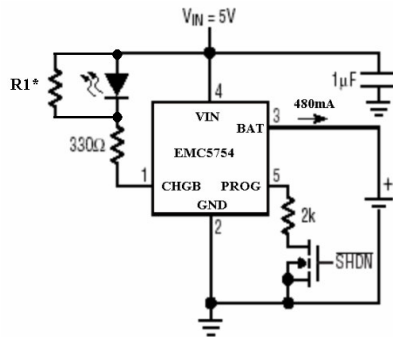

\*The formula for R1 is  $R1 < \frac{V1}{35\mu A}$ , where V1 is the turn-on threshold voltage of the LED device.

Micro Bridge Technology Co., Ltd.

**Typical Performance Characteristics**

Unless otherwise specified,  $V_{IN} = 5V$ ,  $T_A = 25^\circ C$ .

**Regulated Output (Float) Voltage vs Temperature**

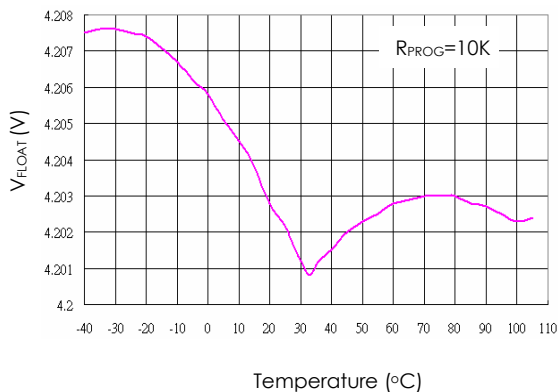

**Charge Current vs Battery Voltage**

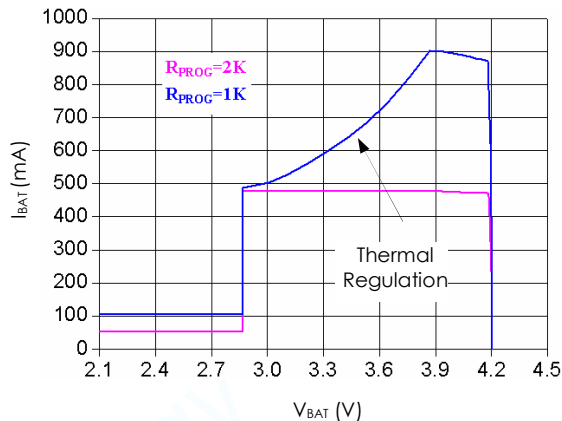

**Charge Current vs Supply Voltage**

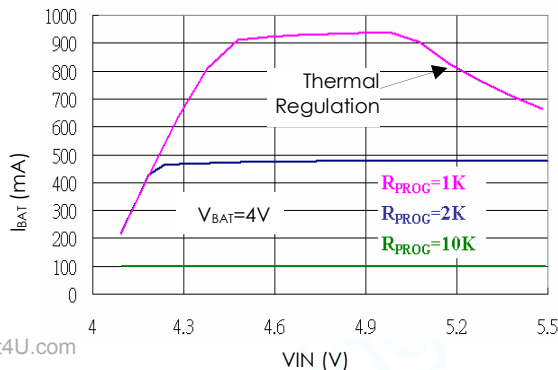

**Charge Current vs Ambient Temperature**

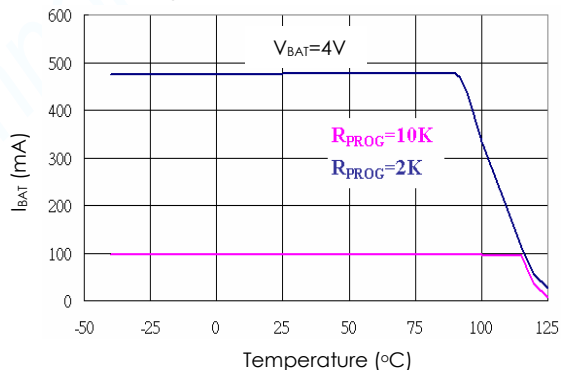

**Regulated Output (Float) Voltage vs Supply Voltage**

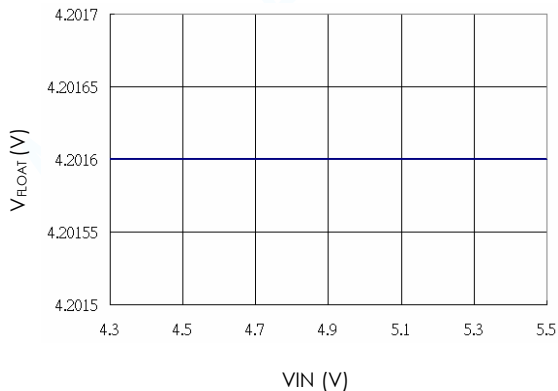

**CHGB Pin I-V Curve (Strong Pull-Down State)**

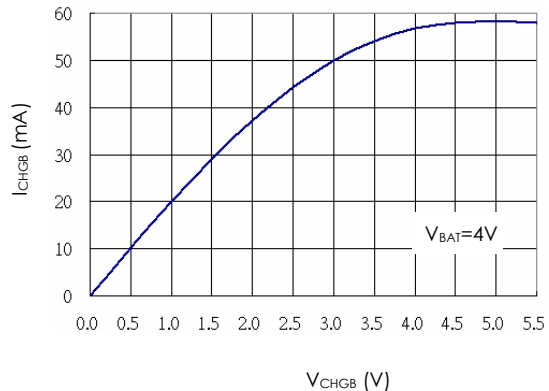

www.DataSheet4U.com

Elite MicroPower Inc. reserves the right to make changes to improve reliability or manufacturability without notice, and customers are advised to obtain the latest version of relevant information prior to placing orders



**Typical Performance Characteristics**

Unless otherwise specified,  $V_{IN} = 5V$ ,  $T_A = 25^\circ C$ . (Continued)

**Load Transient (Battery Removed)**

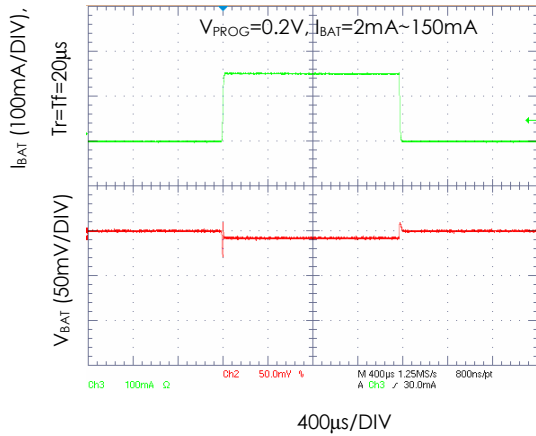

**Line Transient (Battery Removed)**

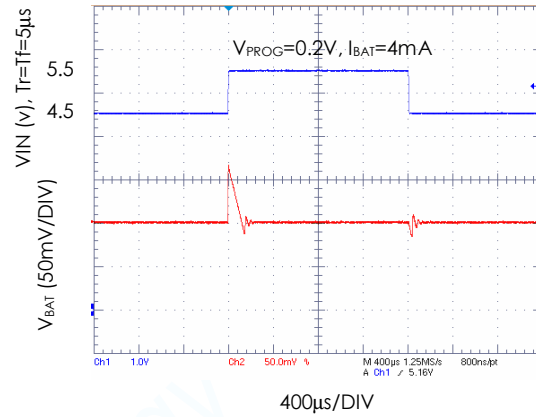

**CHGB Pin Current vs Temperature (Strong Pull-Down State)**

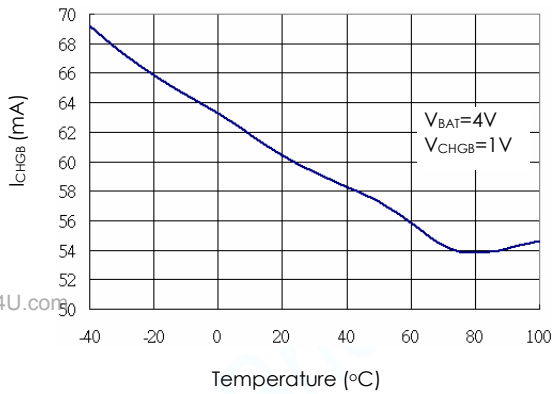

**CHGB Pin I-V Curve (Weak Pull-Down State)**

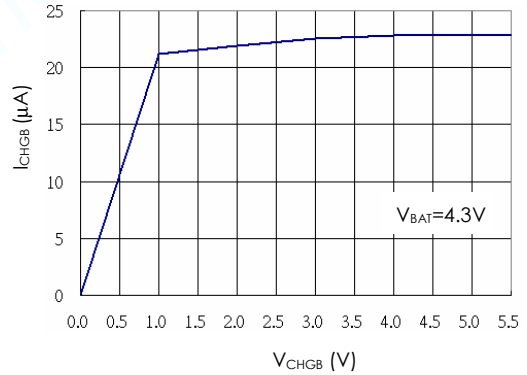

**CHGB Pin Current vs Temperature (Weak Pull-Down State)**

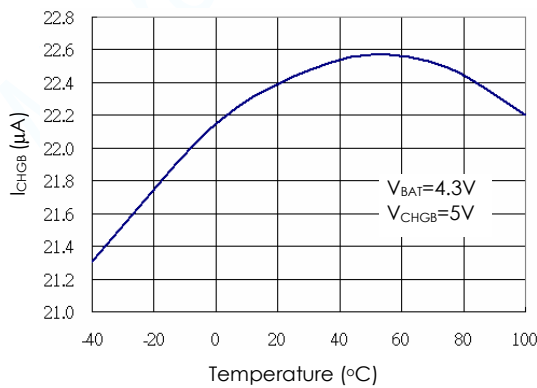

**Trickle Charge Current vs Temperature**

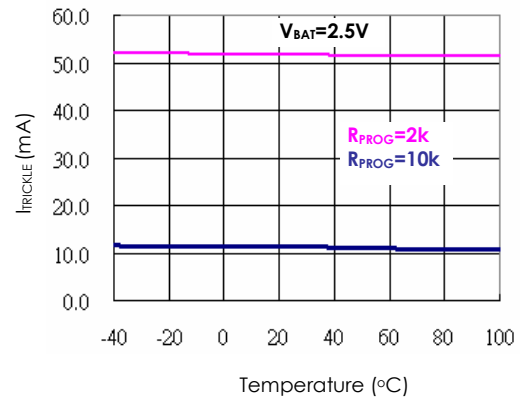

Elite MicroPower Inc. reserves the right to make changes to improve reliability or manufacturability without notice, and customers are advised to obtain the latest version of relevant information prior to placing orders

**Typical Performance Characteristics**

Unless otherwise specified,  $V_{IN} = 5V$ ,  $T_A = 25^\circ C$ . (Continued)

**Trickle Charge Current vs Supply Voltage**

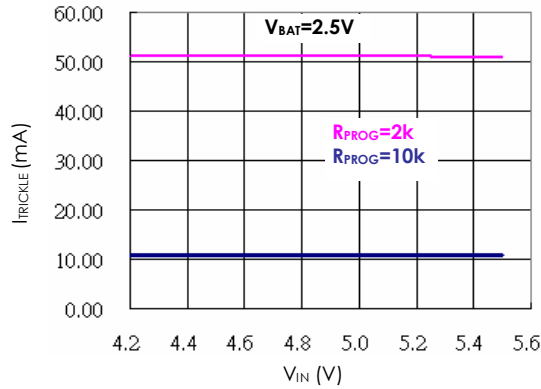

**Trickle Charge Threshold vs Temperature**

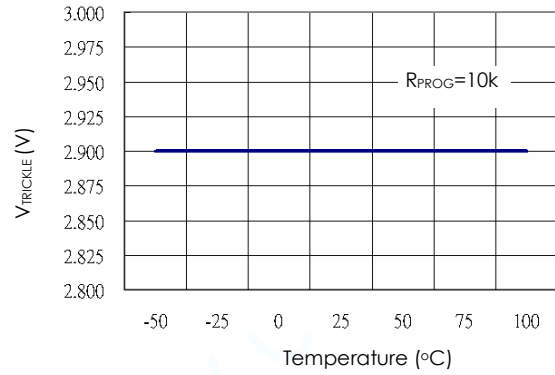

**Recharge Voltage Threshold vs Temperature**

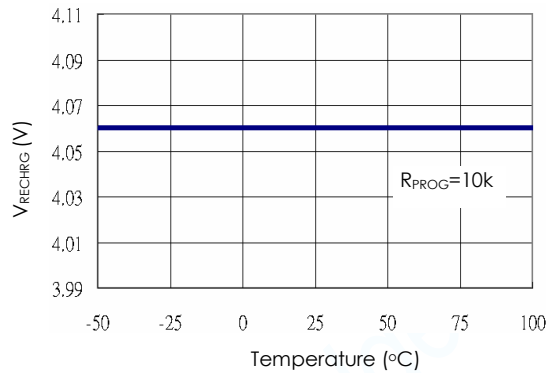

**Regulated Output (Float) Voltage vs Charge Current**

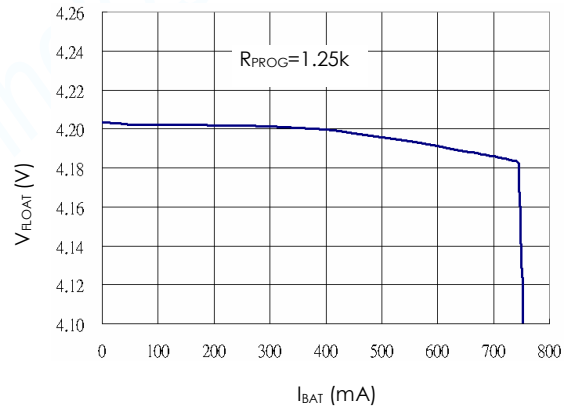

www.DataSheet4U.com

**PROG Pin Voltage vs Supply Voltage (Constant Current Mode)**

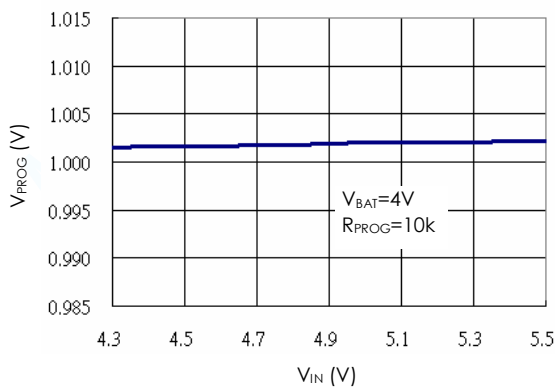

**PROG Pin Voltage vs Temperature**

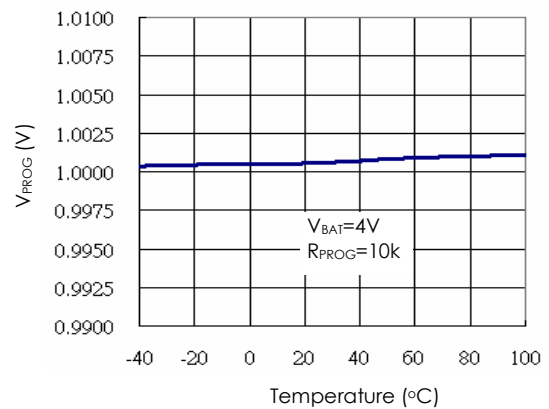

Elite MicroPower Inc. reserves the right to make changes to improve reliability or manufacturability without notice, and customers are advised to obtain the latest version of relevant information prior to placing orders

**Typical Performance Characteristics**

Unless otherwise specified,  $V_{IN} = 5V$ ,  $T_A = 25^\circ C$ . (Continued)

**Charge Current vs PROG Pin Voltage**

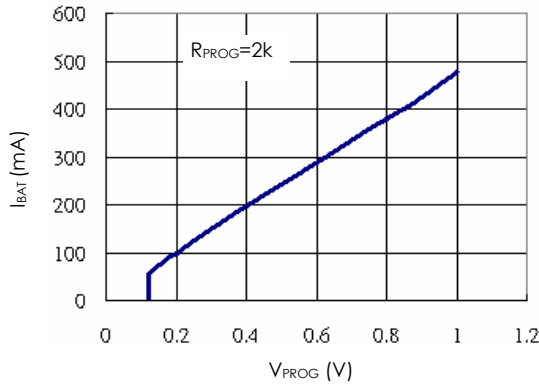

**PROG Pin Pull-Up Current vs Temperature and Supply Voltage**

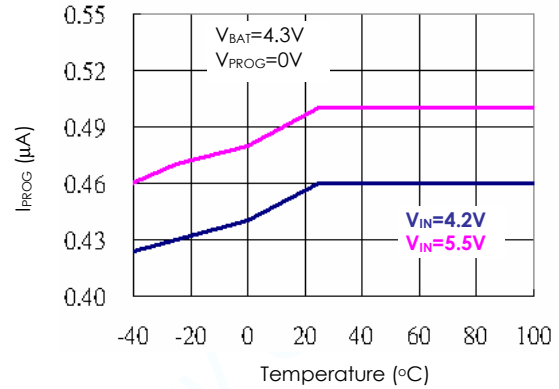

**PROG Pin Current vs PROG Pin Voltage (Pull-Up Current)**

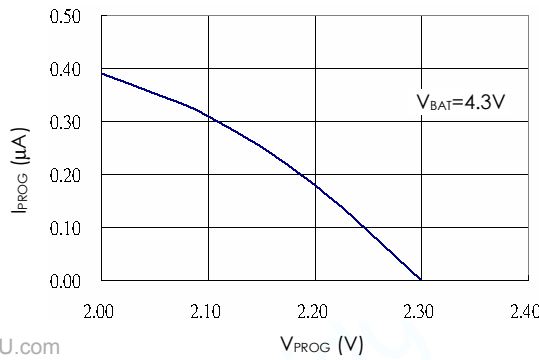

**PROG Pin Current vs PROG Pin Voltage (Clamp Current)**

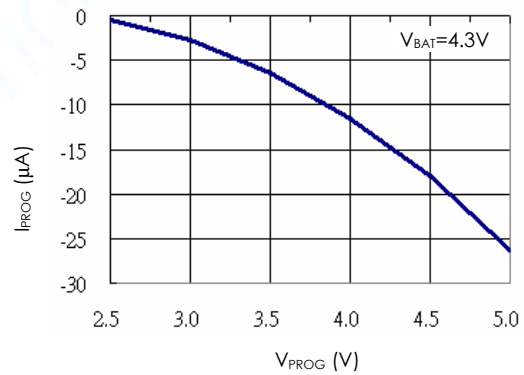

www.DataSheet4U.com

**Power FET "ON" Resistance vs Temperature**

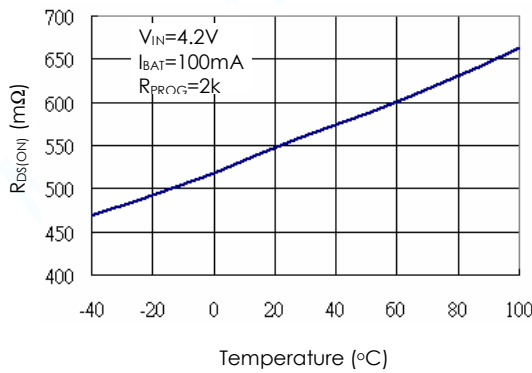

Elite MicroPower Inc. reserves the right to make changes to improve reliability or manufacturability without notice, and customers are advised to obtain the latest version of relevant information prior to placing orders

## Operation

The EMC5754 is a single cell lithium-ion battery charger using a constant-current/constant-voltage algorithm. It can deliver up to 1A of charge current (using a good thermal PCB layout) with a final float voltage accuracy of  $\pm 1\%$ . The EMC5754 includes an internal P-channel power MOSFET and thermal regulation circuitry. No blocking diode or external current sense resistor is required; thus, the basic charger circuit requires only two external components. Furthermore, the EMC5754 is capable of operating from a USB power source.

### Normal Charge Cycle

A charge cycle begins when the voltage at the VIN pin rises above the UVLO threshold level and a 1% program resistor is connected from the PROG pin to ground or when a battery is connected to the charger output. If the BAT pin is less than 2.9V, the charger enters trickle charge mode. In this mode, the EMC5754 supplies approximately 1/10 the programmed charge current to bring the battery voltage up to a safe level for full current charging. When the BAT pin voltage rises above 2.9V, the charger enters constant-current mode, where the programmed charge current is supplied to the battery. When the BAT pin approaches the final float voltage (4.2V), the EMC5754 enters constant-voltage mode and the charge current begins to decrease. When the charge current drops to 1/10 of the programmed value, the charge cycle ends.

### Programming Charge Current

The charge current is programmed using a single resistor from the PROG pin to ground. The battery charge current is 960 times the current out of the PROG pin. The program resistor and the charge current are calculated using the following equations:

$$R_{PROG} = \frac{960V}{I_{CHG}}, \quad I_{CHG} = \frac{960V}{R_{PROG}}$$

[www.DataSheet4U.com](http://www.DataSheet4U.com)

The charge current out of the BAT pin can be determined at any time by monitoring the PROG pin voltage using the following equation:

$$I_{BAT} = \frac{V_{PROG}}{R_{PROG}} \cdot 960$$

### Charge Termination

A charge cycle is terminated when the charge current falls to 1/10th the programmed value after the final float voltage is reached. This condition is detected by using an internal, filtered comparator to monitor the PROG pin. When the PROG pin voltage falls below 100mV for longer than  $T_{TERM}$  (typically 1.1ms), charging is terminated. The charge current is latched off and the EMC5754 enters standby mode, where the input supply current drops to 106 $\mu$ A. (Note: C/10 termination is disabled in trickle charging and thermal limiting modes).

**The EMC5754 draws no current from the battery in standby mode.** This feature reduces the charge and discharge cycles on the battery, further prolonging the battery life.

Any external source ( $V_{PROG}$ ) that holds the PROG pin above 100mV will prevent the EMC5754 from terminating a charge cycle. However, if the PROG pin is controlled by external source, current sourcing from the BAT pin can be infinity (until the internal power MOSFET is burned out or the BAT pin voltage is close to its final float voltage), and the formula for charge current is not valid anymore. Therefore, controlling the PROG pin by external source below 1.1V should be avoided when a battery is connected to BAT pin. However, with no battery present, forcing  $V_{PROG}$  to 0.2V~0.4V enables EMC5754 to act as a LDO (LDO mode). In the LDO mode, load current at the BAT pin is recommended to be below 150mA to avoid overheating.

When charging, transient loads on the BAT pin can cause the PROG pin to fall below 100mV for short periods of time before the DC charge current has dropped to 1/10th the programmed value. The 1.1ms filter time ( $T_{TERM}$ ) on the termination comparator ensures that transient loads of this nature do not result in premature charge cycle termination. Once the average charge current drops below 1/10th the programmed value, the EMC5754 terminates the charge cycle and ceases to provide any current through the BAT pin. This is the standby mode, and all loads on the BAT pin must be supplied by the battery. In the standby mode, any signal below the manual shutdown threshold voltage (typically 1.18V) on the PROG pin is transparent to EMC5754.

The EMC5754 constantly monitors the BAT pin voltage in standby mode. If this voltage drops below the 4.05V recharge threshold ( $V_{RECHRG}$ ), another charge cycle begins and current is once again supplied to the battery. To manually restart a charge cycle when in standby mode, the input voltage must be removed and reapplied, or the charger must be shut down and restarted using the PROG pin.

### Charge Status Indicator (CHGB)

The charge status output has three different states: strong pull-down (~10mA), weak pull-down (~24 $\mu$ A) and high impedance. The strong pull-down state indicates that the EMC5754 is in a charge cycle. Once the charge cycle has terminated, the pin state is determined by undervoltage lockout conditions. A weak pull-down indicates that VIN meets the UVLO conditions and the EMC5754 is ready to charge. High impedance indicates that the EMC5754 is in undervoltage lockout mode: either VIN is less than 80mV above the BAT pin voltage or insufficient voltage is applied to the VIN pin. A microprocessor can be used to distinguish between these three states—this method is discussed in the Applications Information section.

### Thermal Limiting

An internal thermal feedback loop reduces the programmed charge current if the die temperature attempts to rise above a preset value of approximately 120°C. This feature protects the EMC5754 from excessive temperature and allows the user to push the limits of the power handling capability of a given circuit board without risk of damaging the EMC5754. The charge current can be set according to typical (not worst-case) ambient temperature with the assurance that the

*Elite MicroPower Inc. reserves the right to make changes to improve reliability or manufacturability without notice, and customers are advised to obtain the latest version of relevant information prior to placing orders*

charger will automatically reduce the current in worst-case conditions. SOT power considerations are discussed further in the Applications Information section.

**Undervoltage Lockout (UVLO)**

An internal undervoltage lockout circuit monitors the input voltage and keeps the charger in shutdown mode until VIN rises above the undervoltage lockout threshold. The UVLO circuit has a built-in hysteresis of 200mV. Furthermore, to protect against reverse current in the power MOSFET, the UVLO circuit keeps the charger in shutdown mode if VIN falls to within 30mV of the battery voltage. If the UVLO comparator is tripped, the charger will not come out of shutdown mode until VIN rises 80mV above the battery voltage.

**Manual Shutdown**

At any point in the charge cycle, the EMC5754 can be put into shutdown mode by removing R<sub>PROG</sub> thus floating the PROG pin. This reduces the battery drain current to about to 0µA and the supply current to less than 45µA. A

new charge cycle can be initiated by reconnecting the program resistor.

In manual shutdown, the CHGB pin is in a weak pull-down state as long as VIN is high enough to exceed the UVLO conditions. The CHGB pin is in a high impedance state if the EMC5754 is in undervoltage lockout mode: either VIN is within 80mV of the BAT pin voltage or insufficient voltage is applied to the VIN pin.

**Automatic Recharge**

Once the charge cycle is terminated, the EMC5754 continuously monitors the voltage on the BAT pin using a comparator with a 2ms filter time (T<sub>RECHARGE</sub>). A charge cycle restarts when the battery voltage falls below 4.05V (which corresponds to approximately 80% to 90% battery capacity). This ensures that the battery is kept at or near a fully charged condition and eliminates the need for periodic charge cycle initiations. CHGB output enters a strong pulldown state during recharge cycles.

**Application Information**

**Stability Considerations**

The constant-voltage mode feedback loop is stable without an output capacitor provided a battery is connected to the charger output. With no battery present, an output capacitor is recommended to reduce ripple voltage. When using high value, low ESR ceramic capacitors, it is recommended to add a 1Ω resistor in series with the capacitor. No series resistor is needed if tantalum capacitors are used.

In constant-current mode, the PROG pin is in the feedback loop, not the battery. The constant-current mode stability is affected by the impedance at the PROG pin. With no additional capacitance on the PROG pin, the charger is stable with program resistor values as high as 100k. However, additional capacitance on this node reduces the maximum allowed program resistor. The pole frequency at the PROG pin should be kept above 100kHz. Therefore, if the PROG pin is loaded with a capacitance, C<sub>PROG</sub>, the following equation can be used to calculate the maximum resistance value for R<sub>PROG</sub>:

$$R_{PROG} \leq \frac{1}{2\pi \cdot 10^5 \cdot C_{PROG}}$$

Average, rather than instantaneous, charge current may be of interest to the user. For example, if a switching power supply operating in low current mode is connected in parallel with the battery, the average current being pulled out of the BAT pin is typically of more interest than the instantaneous current pulses. In such a case, a simple RC filter can be used on the PROG pin to measure the average battery current as shown in Figure 1. A 10kΩ resistor has been added between the PROG pin and the filter capacitor to ensure stability.

**Power Dissipation**

The conditions that cause the EMC5754 to reduce charge current through thermal feedback can be approximated by considering the power dissipated in the IC. Nearly all of this power dissipation is generated by the internal MOSFET—this is calculated to be approximately:

$$P_D = (V_{IN} - V_{BAT}) \cdot I_{BAT}$$

where P<sub>D</sub> is the power dissipated, V<sub>IN</sub> is the input supply voltage, V<sub>BAT</sub> is the battery voltage and I<sub>BAT</sub> is the charge current. The approximate ambient temperature at which the thermal feedback begins to protect the IC is:

$$T_A = 120^\circ C - P_D \theta_{JA}$$

$$T_A = 120^\circ C - (V_{IN} - V_{BAT}) \cdot I_{BAT} \cdot \theta_{JA}$$

Example: An EMC5754 operating from a 5V USB supply is programmed to supply 500mA full-scale current to a discharged Li-Ion battery with a voltage of 3.7V. Assuming θ<sub>JA</sub> is 100°C/W, the ambient temperature at which the EMC5754 will begin to reduce the charge current is approximately:

$$T_A = 120^\circ C - (5V - 3.7V) \cdot (500mA) \cdot 100^\circ C/W$$

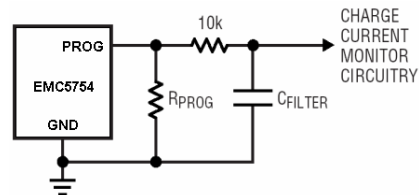

**Figure 1. Isolating Capacitive load on PROG Pin and Filtering**

*Elite MicroPower Inc. reserves the right to make changes to improve reliability or manufacturability without notice, and customers are advised to obtain the latest version of relevant information prior to placing orders*

$$T_A = 120^\circ\text{C} - 0.65\text{W} \cdot 100^\circ\text{C}/\text{W} = 120^\circ\text{C} - 65^\circ\text{C}$$

$$T_A = 55^\circ\text{C}$$

The EMC5754 can be used above 55°C ambient, but the charge current will be reduced from 500mA. The approximate current at a given ambient temperature can be approximated by:

$$I_{BAT} = \frac{120^\circ\text{C} - T_A}{(V_{IN} - V_{BAT}) \cdot \theta_{JA}}$$

Using the previous example with an ambient temperature of 70°C, the charge current will be reduced to approximately:

$$I_{BAT} = \frac{120^\circ\text{C} - 70^\circ\text{C}}{(5 - 3.7) \cdot 100^\circ\text{C}/\text{W}} = \frac{50^\circ\text{C}}{130^\circ\text{C}/\text{A}}$$

$$I_{BAT} = 384\text{mA}$$

Moreover, when thermal feedback reduces the charge current, the voltage at the PROG pin is also reduced proportionally as discussed in the Operation section. It is important to remember that EMC5754 applications do not need to be designed for worst-case thermal conditions since the IC will automatically reduce power dissipation when the junction temperature reaches approximately 120°C.

**Thermal Considerations**

Because of the small size of the SOT package, it is very important to use a good thermal PC board layout to maximize the available charge current. The thermal path for the heat generated by the IC is from the die to the copper lead frame, through the package leads, (especially the ground lead) to the PC board copper. The PC board copper is the heat sink. The footprint copper pads should be as wide as possible and expand out to larger copper areas to spread and dissipate the heat to the surrounding ambient. Feedthrough vias to inner or backside copper layers are also useful in improving the overall thermal performance of the charger. Other heat sources on the board, not related to the charger, must also be considered when designing a PC board layout because they will affect overall temperature rise and the maximum charge current.

**Increasing Thermal Regulation Current**

Reducing the voltage drop across the internal MOSFET can significantly decrease the power dissipation in the

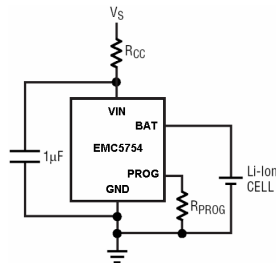

**Figure 2. A Circuit to Maximize Thermal Mode Charge Current**

IC. This has the effect of increasing the current delivered

to the battery during thermal regulation. One method is by dissipating some of the power through an external component, such as a resistor or diode.

Example: An EMC5754 operating from a 5V wall adapter is programmed to supply 1A full-scale current to a discharged Li-Ion battery with a voltage of 3.7V. Assuming  $\theta_{JA}$  is 100°C/W, the approximate charge current at an ambient temperature of 25°C is:

$$I_{BAT} = \frac{120^\circ\text{C} - 25^\circ\text{C}}{(5\text{V} - 3.7\text{V}) \cdot 100^\circ\text{C}/\text{W}} = 730\text{mA}$$

By dropping voltage across a resistor in series with a 5V wall adapter (shown in Figure 2), the on-chip power dissipation can be decreased, thus increasing the thermally regulated charge current

$$I_{BAT} = \frac{120^\circ\text{C} - 25^\circ\text{C}}{(V_S - I_{BAT}R_{CC} - V_{BAT}) \cdot \theta_{JA}}$$

Solving for IBAT using the quadratic formula.

$$I_{BAT} = \frac{1}{2R_{CC}} [(V_S - V_{BAT}) - \sqrt{(V_S - V_{BAT})^2 - \frac{4R_{CC}(120^\circ\text{C} - T_A)}{\theta_{JA}}}]$$

(Note: Large values of Rcc will result in no solution for IBAT. This indicates that the EMC5754 will not generate enough heat to require thermal regulation.)

Using Rcc = 0.25Ω, Vs = 5V, VBAT = 3.7V, TA = 25°C and  $\theta_{JA}$  = 100°C/W we can calculate the thermally regulated charge current to be:

$$I_{BAT} = 879.5\text{mA}$$

While this application delivers more energy to the battery and reduces charge time in thermal mode, it may actually lengthen charge time in voltage mode if VIN becomes low enough to put the EMC5754 into dropout.

This technique works best when Rcc values are minimized to keep component size small and avoid dropout. Remember to choose a resistor with adequate power handling capability.

**VIN Bypass Capacitor**

Many types of capacitors can be used for input bypassing, however, caution must be exercised when using multilayer ceramic capacitors. Because of the self-resonant and high Q characteristics of some types of ceramic capacitors, high voltage transients can be generated under some start-up conditions, such as connecting the charger input to a live power source. Adding a 1.5Ω resistor in series with an X5R ceramic capacitor will minimize start-up voltage transients.

**Charge Current Soft-Start**

The EMC5754 includes a soft-start circuit to minimize the inrush current at the start of a charge cycle. When a charge cycle is initiated, the charge current ramps from zero to the full-scale current over a period of approximately 100µs. This has the effect of minimizing the transient current load on the power supply during start-up.

*Elite MicroPower Inc. reserves the right to make changes to improve reliability or manufacturability without notice, and customers are advised to obtain the latest version of relevant information prior to placing orders*

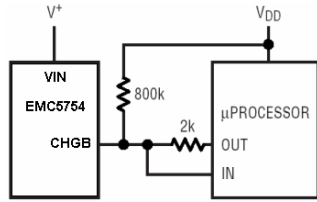

Figure 3. Using a Microprocessor to Determine CHGB State

**CHGB Status Output Pin**

The CHGB pin can provide an indication that the input voltage is greater than the undervoltage lockout threshold level. A weak pull-down current of approximately 24µA indicates that sufficient voltage is applied to VIN to begin charging. When a discharged battery is connected to the charger, the constant current portion of the charge cycle begins and the CHGB pin pulls to ground. The CHGB pin can sink up to 10mA to drive an LED that indicates that a charge cycle is in progress.

When the battery is nearing full charge, the charger enters the constant-voltage portion of the charge cycle and the charge current begins to drop. When the charge current drops below 1/10 of the programmed current, the charge cycle ends and the strong pull-down is replaced by the 24µA pull-down, indicating that the charge cycle has ended. If the input voltage is removed or drops below the undervoltage lockout threshold, the CHGB pin becomes high impedance. Figure 3 shows that by using two different value resistors, a microprocessor can detect all three states from this pin.

To detect when the EMC5754 is in charge mode, force the digital output pin (OUT) high and measure the voltage at the CHGB pin. The internal N-channel MOSFET will pull the pin voltage low even with the 2k pull-up resistor. Once the charge cycle terminates, the N-channel MOSFET is turned off and a 24µA current source is connected to the CHGB pin. The IN pin will then be pulled high by the 2k pull-up resistor. To determine if there is a weak pull-down current, the OUT pin should be forced to a high impedance state. The weak current source will pull the IN pin low through the 800k resistor; if CHGB is high impedance, the IN pin will be pulled high, indicating that the part is in a UVLO state.

**Reverse Polarity Input Voltage Protection**

In some applications, protection from reverse polarity voltage on VIN is desired. If the supply voltage is high enough, a series blocking diode can be used. In other

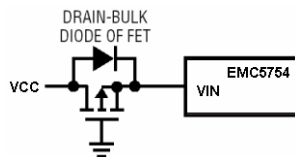

Figure 4. Low Loss Input Reverse Polarity Protection

cases, where the voltage drop must be kept low a P-channel MOSFET can be used (as shown in Figure 4).

**USB and Wall Adapter Power**

The EMC5754 allows charging from both a wall adapter and a USB port. Figure 5 shows an example of how to combine wall adapter and USB power inputs. A P-channel MOSFET, MP1, is used to prevent back conducting into the USB port when a wall adapter is present and a Schottky diode, D1, is used to prevent USB power loss through the 1k pull-down resistor. Typically a wall adapter can supply more current than the 500mA-limited USB port. Therefore, an N-channel MOSFET, MN1, and an extra 10k program resistor are used to increase the charge current to 580mA when the wall adapter is present.

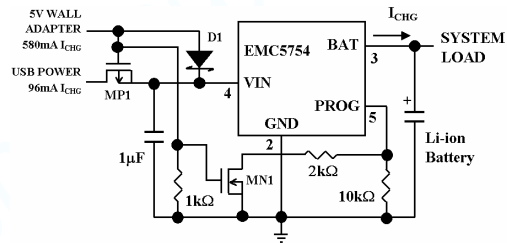
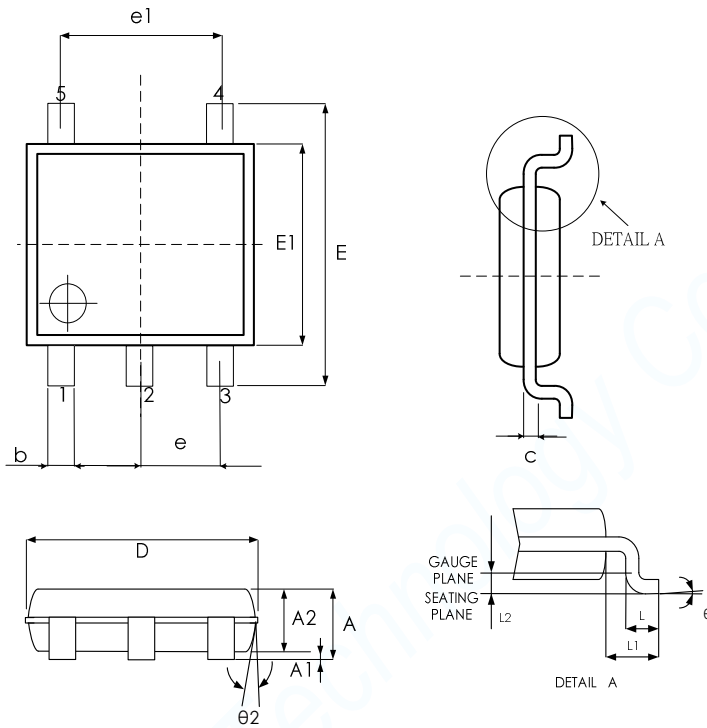

Figure 5. Combining Wall Adapter and USB Power

Elite MicroPower Inc. reserves the right to make changes to improve reliability or manufacturability without notice, and customers are advised to obtain the latest version of relevant information prior to placing orders

**Physical Dimensions**  
**SOT-25**



SYMBPLS	MIN.	NOM.	MAX.
A	1.05	1.20	1.35
A1	0.05	0.10	0.15
A2	1.00	1.10	1.20
b	0.30	—	0.50
c	0.08	—	0.20
D	2.80	2.90	3.00
E	2.60	2.80	3.00
E1	1.50	1.60	1.70
e	0.95 BSC		
e1	1.90 BSC		
L	0.30	0.45	0.55
L1	0.60 REF		
θ°	0	5	10
θ2°	6	8	10

UNIT: MM

Elite MicroPower Inc. reserves the right to make changes to improve reliability or manufacturability without notice, and customers are advised to obtain the latest version of relevant information prior to placing orders



© Copyright 2007 All rights reserved.

No part of this document may be reproduced or duplicated in any form or by any means without the prior permission of EMP.

The contents contained in this document are believed to be accurate at the time of publication. EMP assumes no responsibility for any error in this document, and reserves the right to change the products or specification in this document without notice.

The information contained herein is presented only as a guide or examples for the application of our products. No responsibility is assumed by EMP for any infringement of patents, copyrights, or other intellectual property rights of third parties which may result from its use. No license, either express, implied or otherwise, is granted under any patents, copyrights or other intellectual property rights of EMP or others.

Any semiconductor devices may have inherently a certain rate of failure. To minimize risks associated with customer's application, adequate design and operating safeguards against injury, damage, or loss from such failure, should be provided by the customer when making application designs.

EMP's products are not authorized for use in critical applications such as, but not limited to, life support devices or system, where failure or abnormal operation may directly affect human lives or cause physical injury or property damage. If products described here are to be used for such kinds of application, purchaser must do its own quality assurance testing appropriate to such applications.