

## FEATURES

- **-55° to +125°C operation**
- **16 to 40 VDC input**
- Fully Isolated
- Magnetic feedback
- Fixed frequency, 600 kHz typical
- Topology – Single Ended Forward
- 50 V for up to 50 ms transient protection
- Inhibit (input & output side)
- Sync function (in and out)
- Output trim on single output models
- Indefinite short circuit protection
- Remote sense on single output models
- Up to 87% efficiency / 43 W/in<sup>3</sup>
- Parallelable up to 148 watts

# DC/DC CONVERTERS 28 VOLT INPUT

## MFL SERIES 65 WATT



MODELS	
VDC OUTPUT	
SINGLE	DUAL
5	±5
12	±12
15	±15
28	

Size (max): 3.005 x 1.505 x 0.400 inches (76.33 x 38.23 x 10.16 mm)  
Case U  
Weight: 100 grams maximum  
Screening: Standard, ES, or 883 (Class H).

## DESCRIPTION

The MFL Series™ 28-volt DC/DC converters are rated up to 65 watts of output power over a -55°C to +125°C temperature range with a 28 Vdc nominal input. On dual output models up to 70% of the rated output power can be drawn from either the positive or negative output. Current sharing allows the units to be paralleled for total power of up to 148watts. The welded, hermetically sealed package is only 3.005 x 1.505 x 0.400 inches, giving the series an overall power density of up to 43 watts per cubic inch.

## DESIGN FEATURES

The MFL Series converters are switching regulators that use a quasi-square wave, single ended forward converter design with a constant switching frequency of 600 kHz.

Isolation between input and output circuits is provided with a transformer in the forward path and a wide bandwidth magnetic coupling in the feedback control loop. The MFL uses a unique dual loop feedback technique that controls output current with an inner feedback loop and an output voltage with a cascaded voltage mode feedback loop.

The additional secondary current mode feedback loop improves transient response in a manner similar to primary current mode control and allows for ease of paralleling, but without the cost and complexity.

The cascaded constant frequency, pulse-width modulated converters use a quasi-square wave single-ended forward design. Tight load regulation is achieved through a wide-bandwidth magnetic feedback circuit. The output on single MFL models can be trimmed (see Figure 1 for voltage changes with different resistor values).

## INHIBIT

The MFL Series converters have two TTL compatible inhibit terminals (INH1 and INH2) that can be used to disable power conversion, resulting in a very low quiescent input current and no generation of switching noise. An open collector TTL compatible low (<0.8 volts) is required to inhibit the converter between INH1 (pin 4) and Input Common (pin 2). An open collector TTL compatible low (<0.5 volts) is required to inhibit the converter between INH2 (pin 12) and Output Common (pin 8). The application of intermediate voltages to these pins (1.5 to 10.5 volts) should be avoided.

## CURRENT AND PARALLEL OPERATION

Multiple MFL converters may be used in parallel to drive a common load (see Figure 2). In this mode of operation the load current is shared by two or three MFL converters. In current sharing mode, one MFL converter is designated as a master. The SLAVE pin (pin 11) of the master is left unconnected and the MSTR/INH2 pin (pin 12) of the master is connected to the SLAVE pin (pin 11) of the slave units. The units designated as slaves have the MSTR/INH2 pin (pin 12) connected to the SNS RTN pin (pin 9). Figure 2 shows the typical setup for two or three units in parallel. Note that synchronizing the units together (though shown in the figure) is not required for current sharing operation. A second slave unit may be placed in parallel with a master and slave; this requires the TRI pin (pin 3) of the master unit to be connected to the SNS RTN pin (pin 9).

When paralleled, 76% of the total combined power ratings of the MFL converters are available at the load. Overload and short circuit performance are not adversely affected during parallel operation.

# MFL SERIES 65 WATT

# DC/DC CONVERTERS

**ABSOLUTE MAXIMUM RATINGS**

**Input Voltage**

- 16 to 40 VDC

**Power Dissipation (Pd)**

- 14 watts (16 watts MFL2805S, MFL2805D)

**Output Power**

- 50 to 65 watts depending on model

**Lead Soldering Temperature (10 sec per lead)**

- 300°C

**Storage Temperature Range (Case)**

- -65°C to +150°C

**RECOMMENDED OPERATING CONDITIONS**

**Input Voltage Range**

- 16 to 40 VDC continuous
- 50 V for 120 msec transient

**Case Operating Temperature (Tc)**

- -55°C to +125°C full power
- -55°C to +135°C absolute

**Derate Output Power/Current**

- Linearly from 100% at 125°C to 0% at 135°C

**SYNC AND INHIBIT (INH1, INH2)**

**Sync In (525 to 675 kHz)**

- Duty cycle 40% min, 60% max
- Logic low 0.8 V max
- Logic high 4.5 V min, 9 V max
- Referenced to input common
- If not used, connect to input common

**Sync Out**

- Referenced to input common

**Inhibit (INH1, INH2) TTL Open Collector**

- Logic low (output disabled)
  - INH1 referenced to input common
    - Logic low 0.8 V max
    - Inhibit pin current 10 mA max
  - INH2 referenced to output common
    - Logic low 0.5 V max
    - Inhibit pin current 5 mA max
- Logic high (output enabled)
  - Open collector

**TYPICAL CHARACTERISTICS**

**Output Voltage Temperature Coefficient**

- 100 ppm/°C typical

**Input to Output Capacitance**

- 150 pF, typical

**Isolation**

- 100 megohm minimum at 500 V

**Audio Rejection**

- 50 dB typical

**Conversion Frequency**

- Free run mode 600 kHz typical
- 550 kHz, min, 650 kHz max
- External sync range 525 to 675 kHz

**Inhibit Pin Voltage (unit enabled)**

- INH1 = 9 to 12 V, INH2 = 6 to 9 V

**PINS NOT USED**  
**TR1, Master, and Slave**  
If not used, leave unconnected

**Electrical Characteristics: -55°C to +125°C<sup>1</sup> Tc, 28 VDC Vin, 100% load, free run, unless otherwise specified.**

SINGLE OUTPUT MODELS		MFL2805S			MFL2812S			MFL2815S			MFL2828S <sup>1</sup>			UNITS
PARAMETER	CONDITION	MIN	TYP	MAX	MIN	TYP	MAX	MIN	TYP	MAX	MIN	TYP	MAX <sup>1</sup>	
OUTPUT VOLTAGE	Tc = 25°C	4.95	5.00	5.05	11.88	12.00	12.12	14.85	15.00	15.15	27.72	28.00	28.28	VDC
OUTPUT CURRENT	VIN = 16 TO 40 VDC	0	—	10	0	—	5	0	—	4.33	0	—	2.32	A
OUTPUT POWER	VIN = 16 TO 40 VDC	0	—	50	0	—	60	0	—	65	0	—	65	W
OUTPUT RIPPLE VOLTAGE 10 k - 2 MHz	Tc = 25°C	—	15	35	—	30	75	—	30	85	—	100	200	mV p-p
	Tc = -55°C to +125°C	—	30	50	—	45	100	—	45	110	—	—	—	
LINE REGULATION	VIN = 16 to 40 VDC	—	0	20	—	0	20	—	0	20	—	20	60	mV
LOAD REGULATION	NO LOAD TO FULL	—	0	20	—	0	20	—	0	20	—	20	75	mV
INPUT VOLTAGE NO LOAD TO FULL	CONTINUOUS	16	28	40	16	28	40	16	28	40	16	28	40	VDC
	TRANSIENT <sup>2</sup> 50 ms	—	—	50	—	—	50	—	—	50	—	—	50	V
INPUT CURRENT	NO LOAD	—	70	120	—	50	80	—	50	80	—	60	100	mA
	FULL LOAD	—	—	2.5	—	—	2.8	—	—	3.0	—	—	2.8	A
	INHIBITED - INH1	—	9	14	—	9	14	—	9	14	—	9	14	mA
	INHIBITED - INH2	—	35	70	—	35	70	—	35	70	—	35	70	
INPUT RIPPLE CURRENT	10 kHz - 10 MHz	—	15	50	—	15	50	—	15	50	—	20	50	mA pp
EFFICIENCY	Tc = 25°C	77	80	—	83	86	—	84	87	—	83	86	—	%
LOAD FAULT <sup>3</sup>	POWER DISSIPATION SHORT CIRCUIT													
	Tc = 25°C	—	12.5	16	—	10	14	—	10	14	—	7	14	A
	RECOVERY	—	1.5	4	—	1.5	4	—	1.5	4	—	1.0	4	ms
STEP LOAD RESP.	50% - 100% - 50%													
	TRANSIENT RECOVERY <sup>4</sup>	—	250	350	—	450	600	—	500	600	—	800	1400	mV pk
	RECOVERY <sup>4</sup>	—	1.5	3.0	—	1.5	3.0	—	1.5	3.0	—	1.5	3.0	ms
STEP LINE RESP.	16 - 40 - 16 VDC													
	TRANSIENT <sup>5</sup> RECOVERY <sup>4</sup>	—	250	300	—	250	400	—	250	400	—	250	800	mV pk
	RECOVERY <sup>4</sup>	—	200	300	—	200	300	—	200	300	—	200	400	µs
START-UP	DELAY	—	3.5	6	—	3.5	6	—	3.5	6	—	3.5	6	ms
	OVERSHOOT	—	0	25	—	0	50	—	0	50	—	0	100	mV pk

Notes

1. MFL2828S specifications are at 25°C Tc, contact your Interpoint representative for more information.
2. Unit will shut down above approximately 45V but will be undamaged and will restart when voltage drops into normal range.
3. Indefinite short circuit protection not guaranteed above 125°C case.
4. Recovery time is measured from application of the transient to point at which Vout is within 1% of final value.
5. Transition time ≥ 10 µs.



# DC/DC CONVERTERS

# MFL SERIES 65 WATT

Electrical Characteristics: -55°C to +125°C Tc, 28 VDC Vin, 100% load, free run, unless otherwise specified.

DUAL OUTPUT MODELS		MFL2805D			MFL2812D			MFL2815D			UNITS
PARAMETER	CONDITIONS	MIN	TYP	MAX	MIN	TYP	MAX	MIN	TYP	MAX	
OUTPUT VOLTAGE	Tc = 25°C +V <sub>OUT</sub> -V <sub>OUT</sub>	4.95	5.00	5.05	11.88	12.00	12.12	14.85	15.00	15.15	VDC
		4.92	5.00	5.08	11.82	12.00	12.18	14.77	15.00	15.23	
OUTPUT CURRENT <sup>1</sup> V <sub>IN</sub> = 16 TO 40 VDC	EACH OUTPUT	0	—	7	0	—	3.5	0	—	3.03	A
	TOTAL OUTPUT	0	—	10	0	—	5	0	—	4.34	
OUTPUT POWER	V <sub>IN</sub> = 16 TO 40 VDC	0	—	50	0	—	60	0	—	65	W
OUTPUT RIPPLE VOLTAGE +/- V <sub>OUT</sub>	10 kHz - 2 MHz	—	50	100	—	50	120	—	50	150	mV p-p
LINE REGULATION V <sub>IN</sub> = 16 TO 40 VDC	+V <sub>OUT</sub>	—	0	50	—	0	50	—	0	50	mV
	-V <sub>OUT</sub>	—	25	100	—	25	100	—	25	100	
LOAD REGULATION NO LOAD TO FULL	+V <sub>OUT</sub>	—	0	50	—	10	100	—	10	100	mV
	-V <sub>OUT</sub>	—	25	100	—	50	120	—	50	150	
CROSS REGULATION Tc = 25°C	SEE NOTE 2	—	5	8	—	2	4	—	2	4	%
	SEE NOTE 3	—	3	6	—	2	4	—	2	4	
INPUT VOLTAGE NO LOAD TO FULL	CONTINUOUS	16	28	40	16	28	40	16	28	40	VDC
INPUT CURRENT Tc = 25°C	TRANSIENT <sup>4</sup> 50 ms.	0	—	50	0	—	50	0	—	50	V
	NO LOAD	—	50	120	—	50	100	—	50	100	mA
INPUT RIPPLE CURRENT 10 kHz - 10 MHz	FULL LOAD	—	—	—	—	—	2.80	—	—	3.00	A
	INHIBITED - INH1	—	9	14	—	9	14	—	9	14	mA
	INHIBITED - INH2	—	35	70	—	35	70	—	35	70	
EFFICIENCY 25°C Tc	BALANCED LOAD	77	80	—	83	86	—	84	87	—	%
LOAD FAULT <sup>5</sup> Tc = 25°C	POWER DISSIPATION	—	12.5	16	—	10	14	—	10	14	W
	SHORT CIRCUIT RECOVERY	—	1.5	4.0	—	1.5	4.0	—	1.5	4.0	ms
STEP LOAD RESPONSE ± V <sub>OUT</sub>	50%–100%–50% LOAD TRANSIENT	—	250	350	—	450	600	—	500	600	mV pk
	RECOVERY <sup>6</sup>	—	1.5	3.0	—	1.5	3.0	—	1.5	3.0	ms
STEP LINE RESPONSE ± V <sub>OUT</sub>	16 – 40 – 16 V <sub>IN</sub> TRANSIENT <sup>7</sup>	—	250	300	—	250	400	—	250	400	mV pk
	RECOVERY <sup>6</sup>	—	200	300	—	200	300	—	200	300	µs
START-UP	DELAY	—	3.5	6	—	3.5	6	—	3.5	6	ms
	OVERSHOOT	—	0	25	—	0	50	—	0	50	mV p

## Notes

- Up to 70% of the total output power is available from either output providing the opposite output is simultaneously carrying 30% of the total power.
- Effect on the negative output under the following conditions:  
+P<sub>out</sub> 30% to 70%; -P<sub>out</sub> 70% to 30%
- Effect on the negative output under the following conditions:  
+P<sub>out</sub> 50%; -P<sub>out</sub> 10% to 50%
- Unit will shut down above approximately 45V but will be undamaged and will restart when voltage drops into normal range.
- Indefinite short circuit protection not guaranteed above 125°C case.
- Recovery time is measured from application of the transient to point at which V<sub>out</sub> is within 1% of final value.
- Transition time ≥ 10 µs.

**MFL SERIES  
65 WATT**

**DC/DC CONVERTERS**

**SINGLE OUTPUT MODELS CONNECTION DIAGRAMS - SENSE AND PARALLEL**

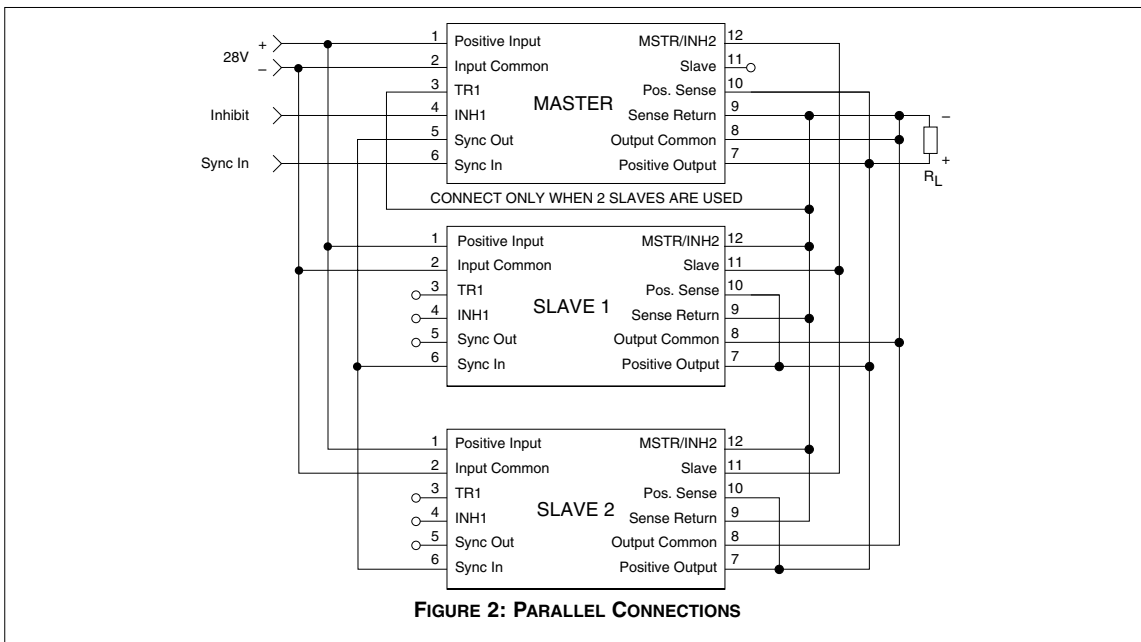
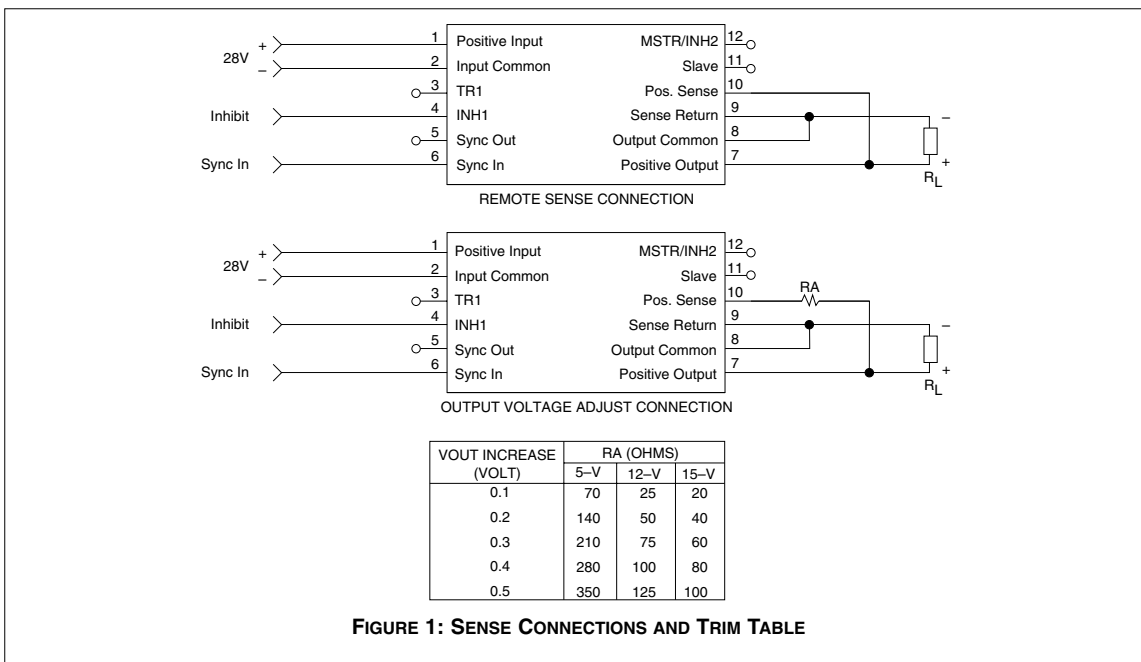

# DC/DC CONVERTERS

# MFL SERIES 65 WATT

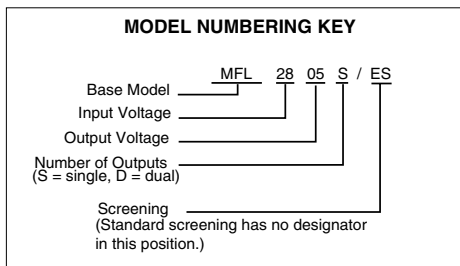
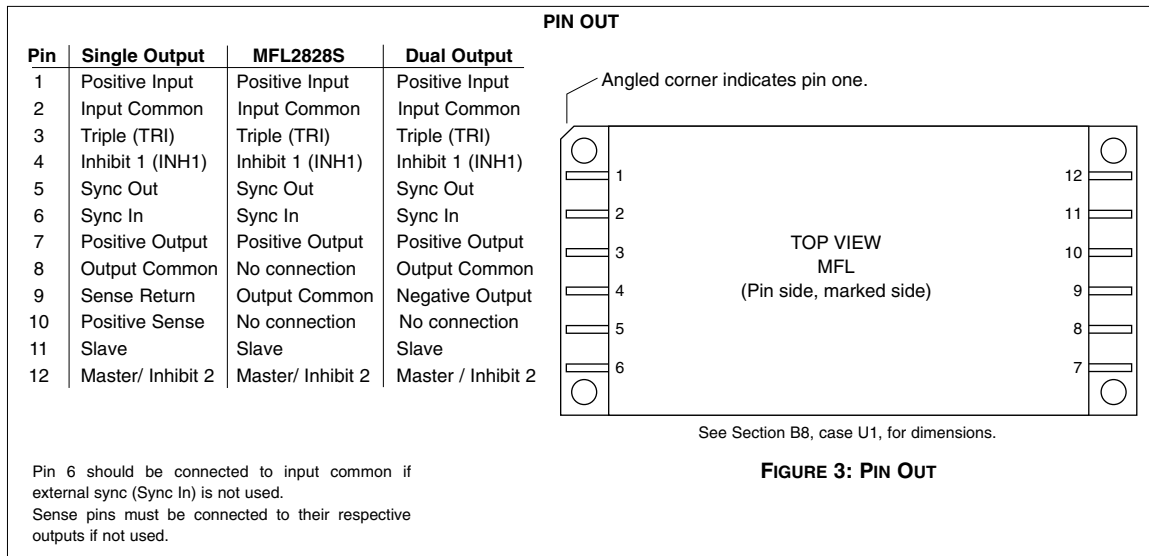

SMD NUMBERS	
STANDARD MICROCIRCUIT DRAWING (SMD)	MFL SERIES SIMILAR PART
5962-9316301HXC	MFL2805S/883
5962-9316201HXC	MFL2812S/883
5962-9316101HXC	MFL2815S/883
IN PROCESS	MFL2828S/883
5962-9319101HXC	MFL2805D/883
5962-9319201HXC	MFL2812D/883
5962-9319301HXC	MFL2815D/883

For exact specifications for an SMD product, refer to the SMD drawing. See Section A3, SMDs, for more information.

**Typical Performance Curves: 25°C Tc , 28 VDC Vin, 100% load, free run, unless otherwise specified.**

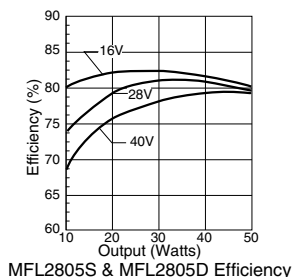

**FIGURE 4**

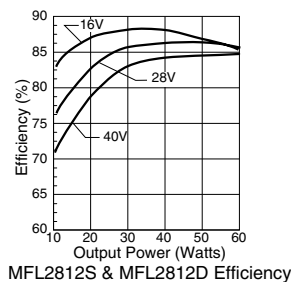

**FIGURE 5**

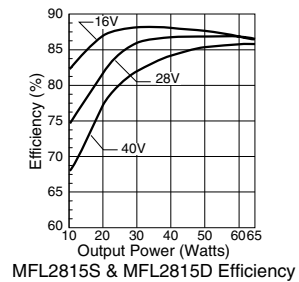

**FIGURE 6**

# MFL SERIES 65 WATT

# DC/DC CONVERTERS

Typical Performance Curves: 25°C Tc, 28 VDC Vin, 100% load, free run, unless otherwise specified.

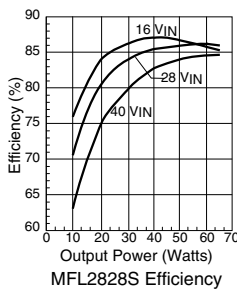

FIGURE 7

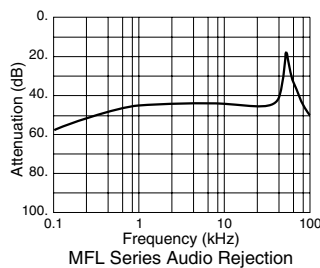

FIGURE 8

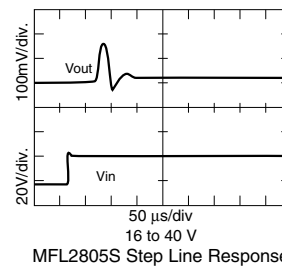

FIGURE 9

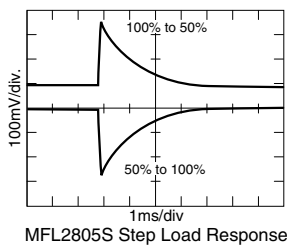

FIGURE 10

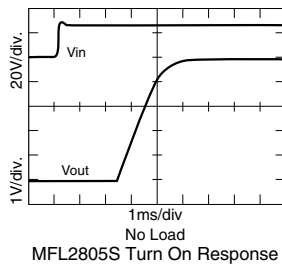

FIGURE 11

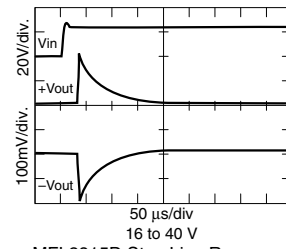

FIGURE 12

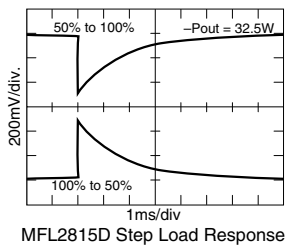

FIGURE 13

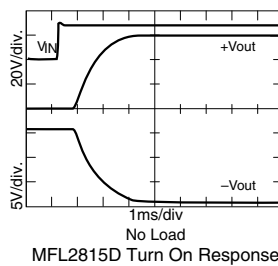

FIGURE 14

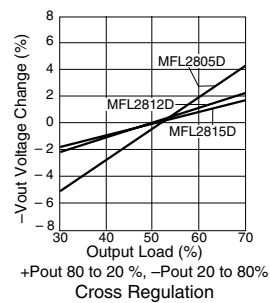

FIGURE 15

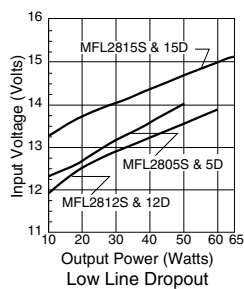
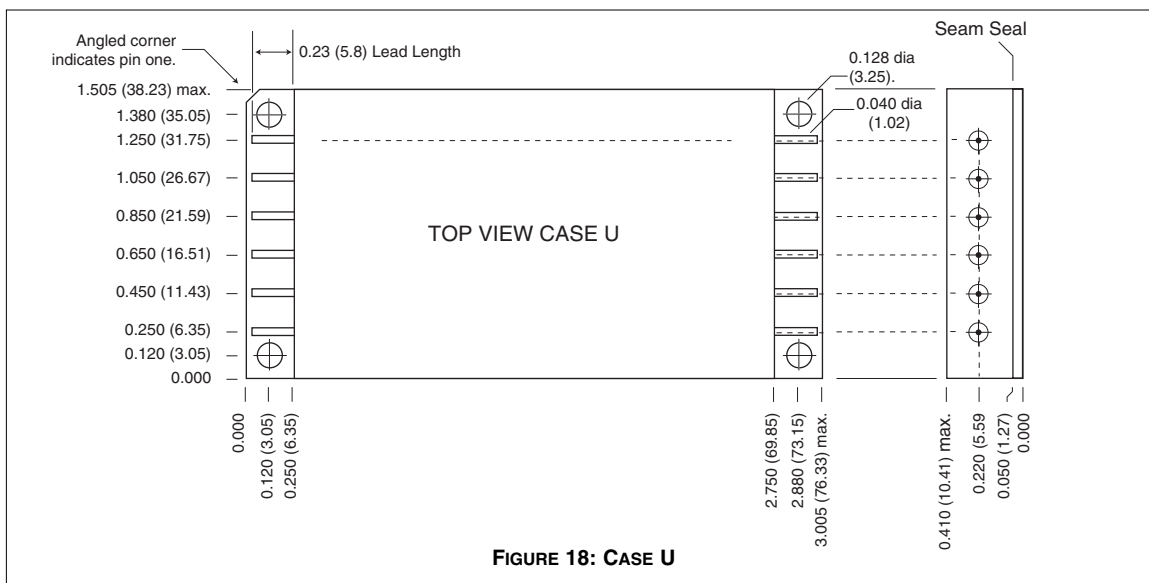
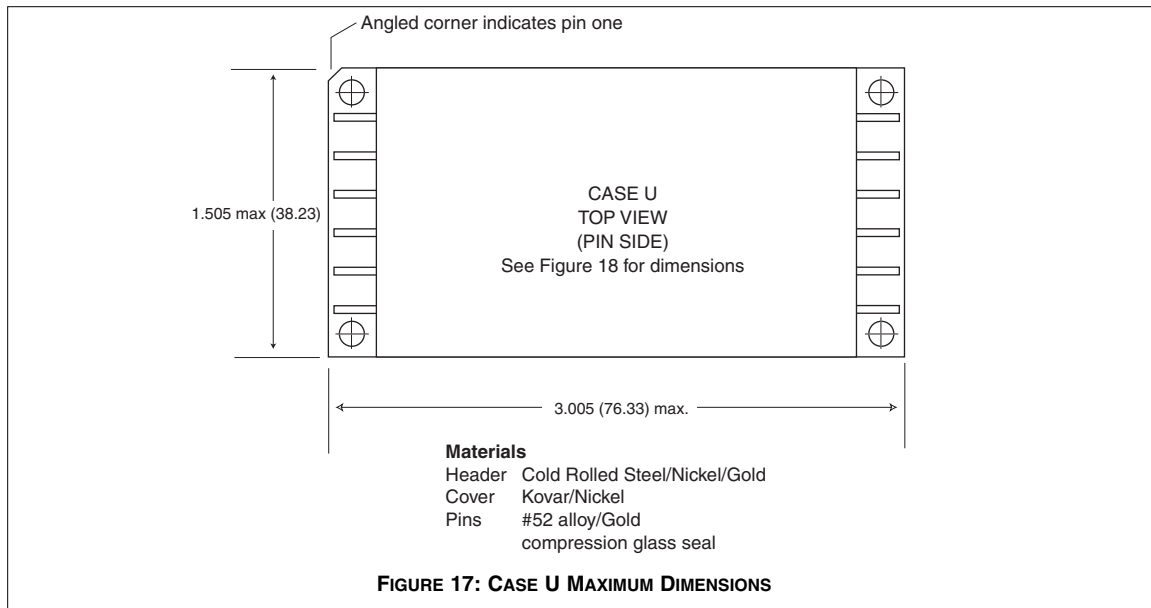

FIGURE 16

# DC/DC CONVERTERS

# MFL SERIES 65 WATT



### CAUTION

Heat from reflow or wave soldering may damage the device. Solder pins individually with heat application not exceeding 300°C for 10 seconds per pin.

### Case dimensions in inches (mm)

Tolerance  $\pm 0.005$  (0.13) for three decimal places,  $\pm 0.01$  (0.2) for two decimal places unless otherwise specified

Although every effort has been made to render the case drawings at actual size, variations in the printing process may cause some distortion. Please refer to the numerical dimensions for accuracy.

**MFL SERIES  
65 WATT**

**DC/DC CONVERTERS**

**ENVIRONMENTAL SCREENING**

TEST	STANDARD	/ES	/883 (Class H)*
PRE-CAP INSPECTION Method 2017, 2032	yes	yes	yes
TEMPERATURE CYCLE (10 times) Method 1010, Cond. C, -65°C to 150°C Method 1010, Cond. B, -55°C to 125°C	no no	no yes	yes no
CONSTANT ACCELERATION Method 2001, 3000 g Method 2001, 500 g	no no	no yes	yes no
BURN-IN Method 1015, 160 hours at 125°C 96 hours at 125°C case (typical)	no no	no yes	yes no
FINAL ELECTRICAL TEST MIL-PRF-38534, Group A Subgroups 1 through 6: -55°C, +25°C, +125°C Subgroups 1 and 4: +25°C case	no yes	no yes	yes no
HERMETICITY TESTING Fine Leak, Method 1014, Cond. A Gross Leak, Method 1014, Cond. C Gross Leak, Dip (1 x 10 <sup>-3</sup> )	no no yes	yes yes no	yes yes no
FINAL VISUAL INSPECTION Method 2009	yes	yes	yes

Test methods are referenced to MIL-STD-883 as determined by MIL-PRF-38534.

\*883 products are built with element evaluated components and are 100% tested and guaranteed over the full military temperature range of -55°C to +125°C.

**Contact Information:**

[www.interpoint.com](http://www.interpoint.com)

Interpoint Headquarters USA  
Phone: 1-800-822-8782  
+425-882-3100  
Email: [power@intp.com](mailto:power@intp.com)

Interpoint UK  
Phone: +44-1252-872266  
Email: [poweruk@intp.com](mailto:poweruk@intp.com)

Interpoint France  
Phone: +33-134285455  
Email: [powerfr@intp.com](mailto:powerfr@intp.com)