

8.5-11.0 GHz GaAs Power Amplifier Flange, 10 pin

Mimix
BROADBAND™

August 2006 - Rev 16-Aug-06

X P1006-FA
X RoHS

Features

- X X-Band 10W Power Amplifier
- X Flange Package
- X 21.5 dB Large Signal Gain
- X +40.5 dBm Saturated Output Power
- X 37% Power Added Efficiency
- X 100% On-Wafer RF, DC and Output Power Testing

General Description

Mimix Broadband's three stage 8.5-11.0 GHz GaAs packaged power amplifier has a large signal gain of 21.5 dB with a +40.5 dBm saturated output power. This device uses Mimix Broadband's 0.5 μ m GaAs PHEMT device model technology, and is based upon optical gate lithography to ensure high repeatability and uniformity. The device comes in a 10 pin, high frequency, LCC flange package. The package has a copper composite base material and a laminated ceramic substrate. This device is well suited for radar applications.

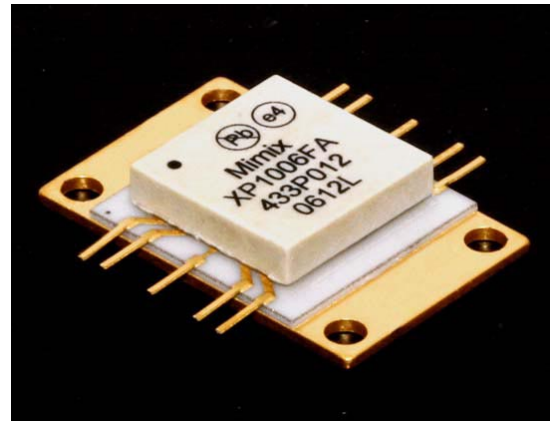

Absolute Maximum Ratings

Supply Voltage (Vd)	+9.0 VDC
Supply Current (Id)	4.5 A
Gate Bias Voltage (Vg)	+0.0 VDC
Input Power (Pin)	TBD
Storage Temperature (Tstg)	-65 to +165 °C
Operating Temperature (Ta)	-55 to MTTF Table ¹
Channel Temperature (Tch)	MTTF Table ¹

(1) Channel temperature affects a device's MTTF. It is recommended to keep channel temperature as low as possible for maximum life.

Electrical Characteristics (Pulsed Mode F=10kHz, Duty Cycle=5%, TA=25°C)

Parameter	Units	Min.	Typ.	Max.
Frequency Range (f)	GHz	8.5	-	11.0
Input Return Loss (S11) ¹	dB	-	15.0	-
Output Return Loss (S22) ¹	dB	-	12.0	-
Large Signal Gain (S21)	dB	-	21.5	-
Gain Flatness (Δ S21)	dB	-	+/-0.5	-
Reverse Isolation (S12) ¹	dB	-	60.0	-
Saturated Output Power (P _{SAT})	dBm	-	+40.5	-
Power Added Efficiency (PAE)	%	-	37	-
Drain Bias Voltage (Vd1,2,3)	VDC	-	+8.0	+9.0
Gate Bias Voltage (Vg)	VDC	-	-0.6	-
Supply Current (Id) (Vd=8.0V, Vg=-0.6V Typical)	A	-	4.0	4.5

(1) Measured on-wafer pre-packaging.

8.5-11.0 GHz GaAs Power Amplifier Flange, 10 pin



August 2006 - Rev 16-Aug-06

✕ P1006-FA
✕ RoHS

Power Amplifier Measurements (Pulsed Mode F=10kHz, Duty Cycle=5%, T_A=25°C)

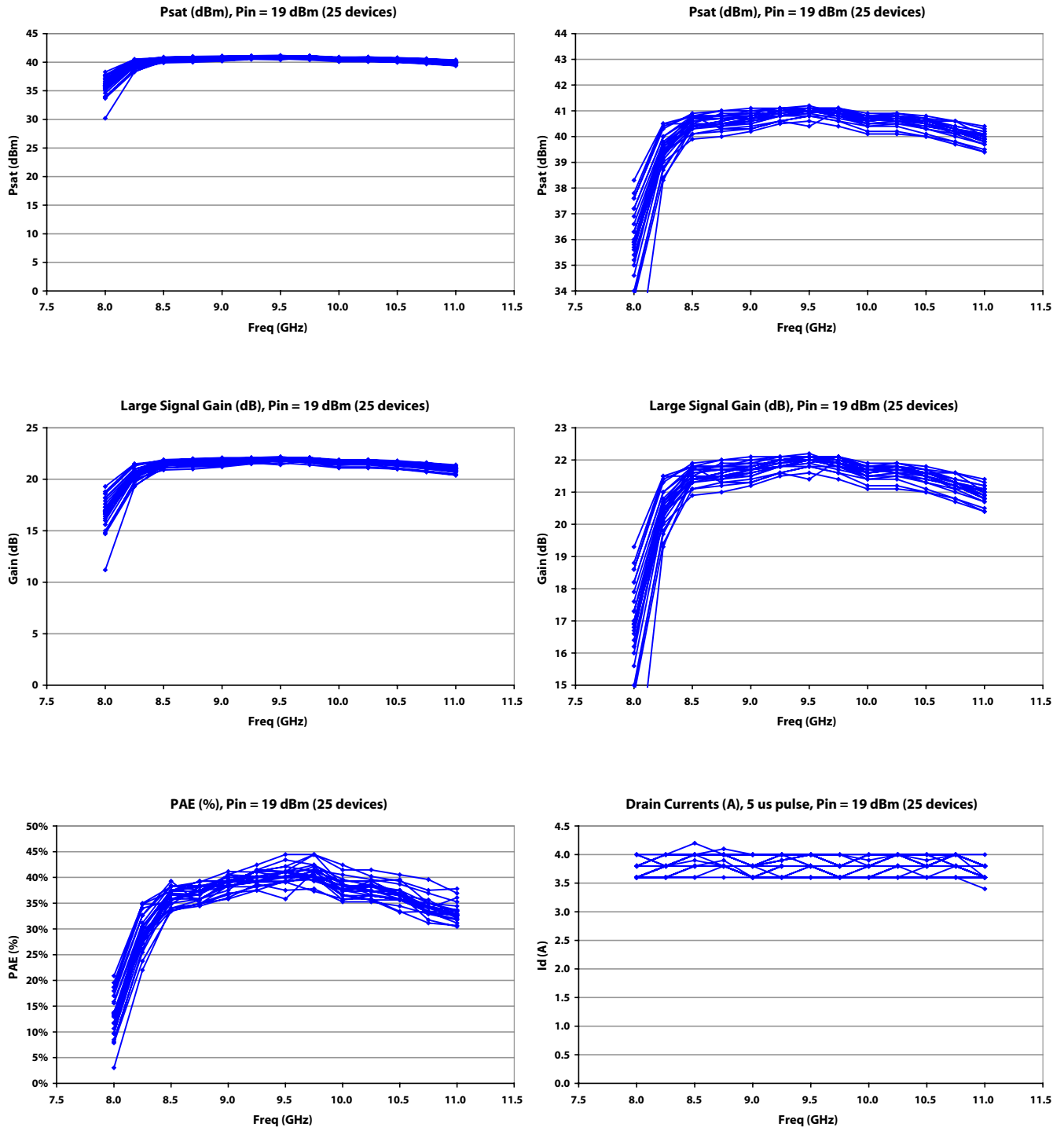

8.5-11.0 GHz GaAs Power Amplifier Flange, 10 pin



August 2006 - Rev 16-Aug-06

XP1006-FA
RoHS

Power Amplifier Measurements (Pulsed Mode F=10kHz, Duty Cycle=5%, T_A=25°C)

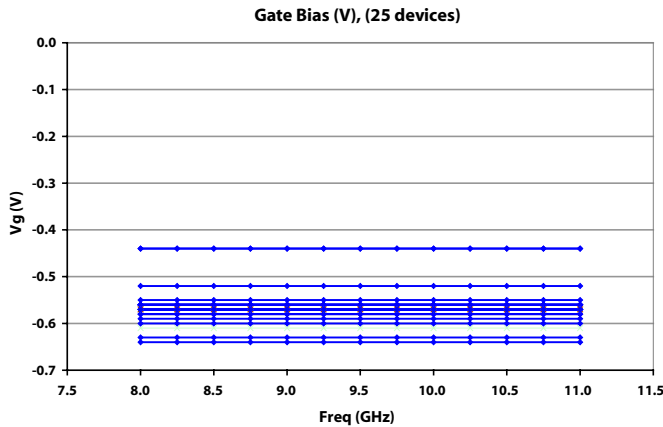

Following test conditions apply for all measured data unless otherwise stated: V_D = 8.0V, 4.0A. Pin = +20dBm, Temp = +25C, Pulsed Duty Cycle = 5%

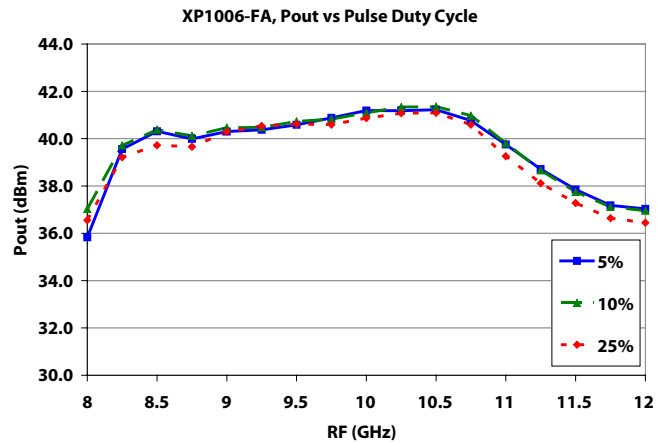
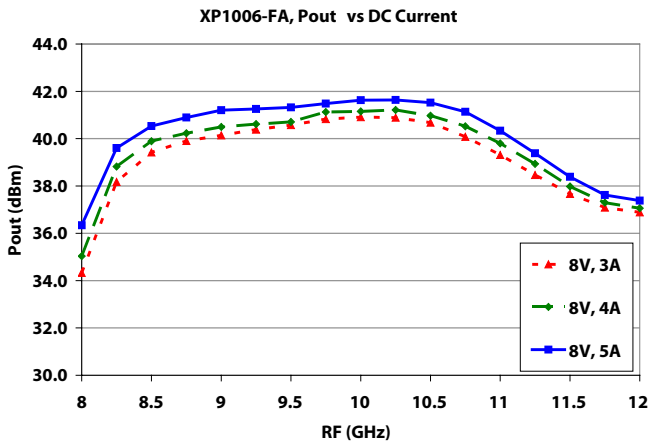
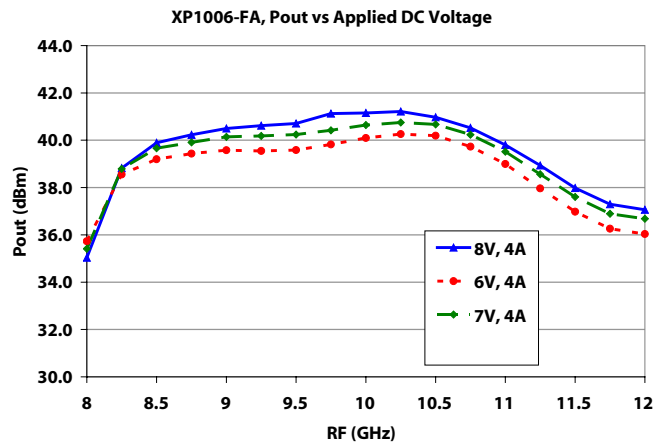
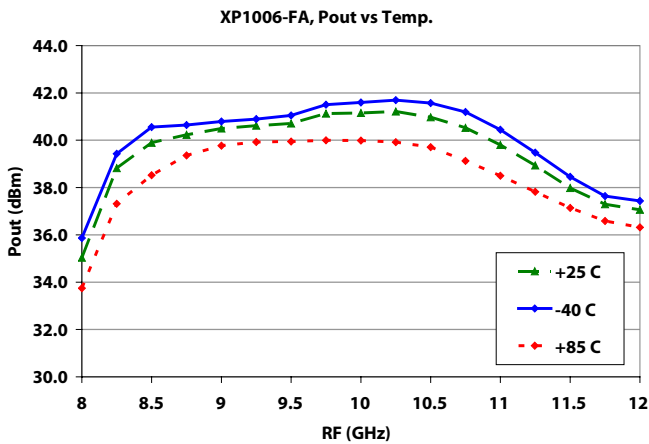

8.5-11.0 GHz GaAs Power Amplifier Flange, 10 pin

August 2006 - Rev 16-Aug-06

PI006-FA
RoHS

Physical Dimensions

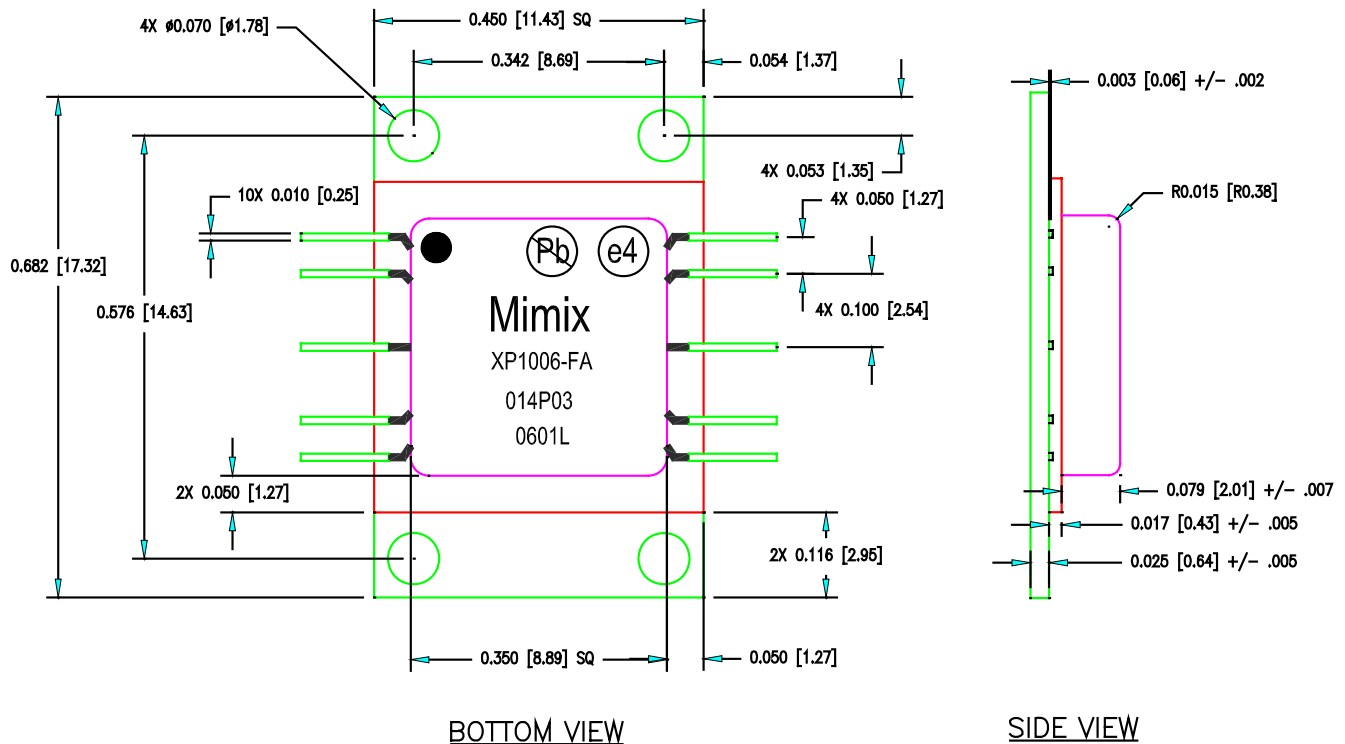

BOTTOM VIEW

SIDE VIEW

(Note: Engineering designator is I0004966)

Functional Schematic

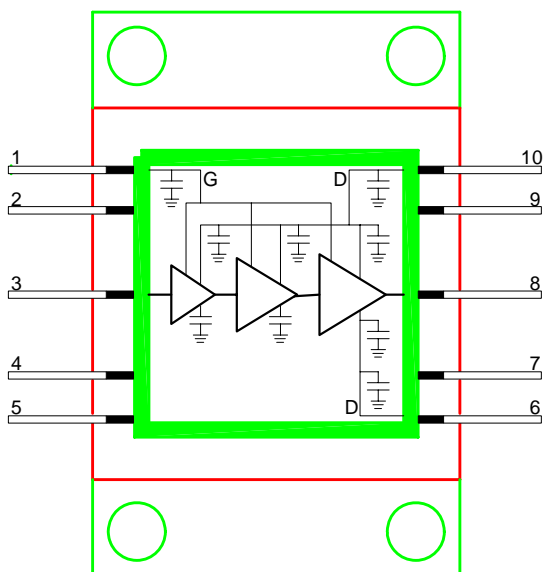

Pin Designations

Pin	Description	Typ. Values
0 (Flange)	GND	
1	Vg	-0.6 V
2	NC	
3	RF In	+19.0 dBm
4	NC	
5	NC	
6	Vd(3)	8.0 V
7	NC	
8	RF Out	+40.0 dBm
9	NC	
10	Vd(1,2,3)	8.0 V

8.5-11.0 GHz GaAs Power Amplifier Flange, 10 pin



August 2006 - Rev 16-Aug-06

XP1006-FA
RoHS

App Note [1] Biasing - This device is biased with $V_d(1,2,3) = 8.0V$ and $4.0 A$ (pin 6,10). The drain current is controlled by the gate bias with a typical value of $V_g = -0.6V$ (pin 1). It is recommended to use active biasing to keep the currents constant as the RF power and temperature vary; this gives the most reproducible results. The recommended power-up sequence is described below:

1. Apply -2.0 V to V_g
2. Apply +8.0 V to $V_d(1,2,3)$
3. Adjust V_g to achieve nominal drain current
4. Apply RF power
5. Re-adjust V_g to maintain nominal drain current.

Depending on the supply voltage available and the power dissipation constraints, the bias circuit may be a single transistor or a low power operational amplifier, with a low value resistor in series with the drain supply used to sense the current. The gate of the pHEMT is controlled to maintain correct drain current and thus drain voltage.

MTTF

MTTF is calculated from accelerated life-time data of single devices and assumes an isothermal back-plate.

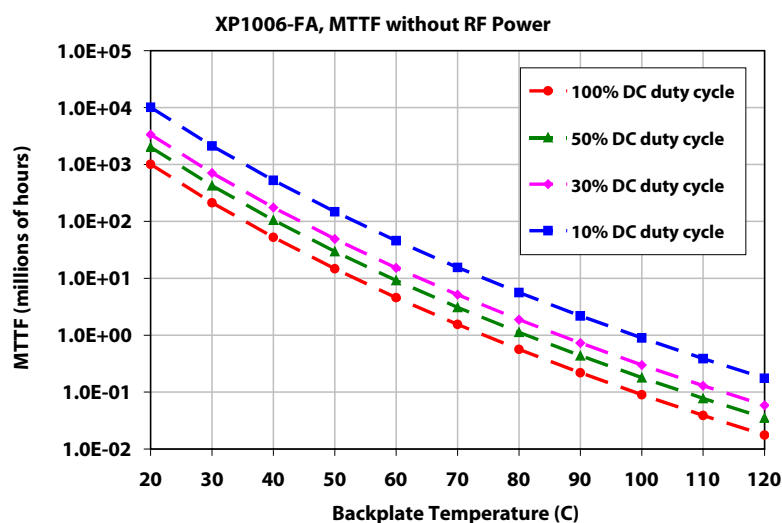
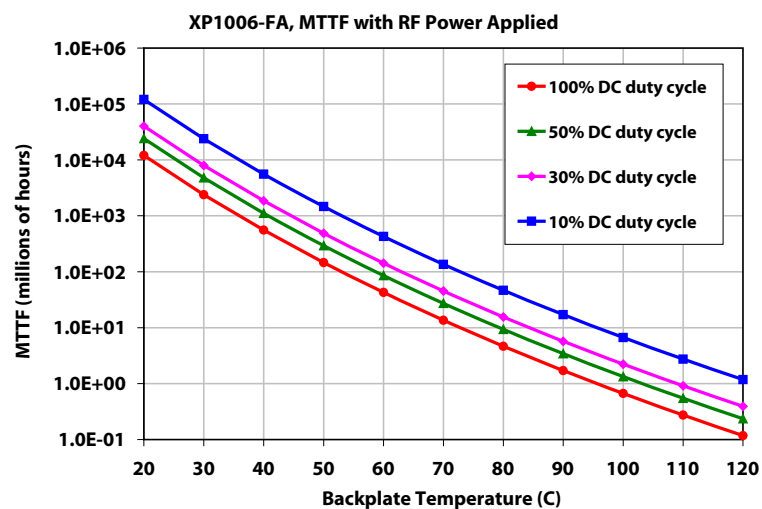

8.5-11.0 GHz GaAs Power Amplifier Flange, 10 pin



August 2006 - Rev 16-Aug-06

XP1006-FA
RoHS

Handling and Assembly Information

CAUTION! - Mimix Broadband MMIC Products contain gallium arsenide (GaAs) which can be hazardous to the human body and the environment. For safety, observe the following procedures:

- Do not ingest.
- Do not alter the form of this product into a gas, powder, or liquid through burning, crushing, or chemical processing as these by-products are dangerous to the human body if inhaled, ingested, or swallowed.
- Observe government laws and company regulations when discarding this product. This product must be discarded in accordance with methods specified by applicable hazardous waste procedures.

Life Support Policy - Mimix Broadband's products are not authorized for use as critical components in life support devices or systems without the express written approval of the President and General Counsel of Mimix Broadband. As used herein: (1) Life support devices or systems are devices or systems which, (a) are intended for surgical implant into the body, or (b) support or sustain life, and whose failure to perform when properly used in accordance with instructions for use provided in the labeling, can be reasonably expected to result in a significant injury to the user. (2) A critical component is any component of a life support device or system whose failure to perform can be reasonably expected to cause the failure of the life support device or system, or to affect its safety or effectiveness.

Mounting Onto Circuit Boards - Special design considerations allow the -FA packages to operate at high frequencies. One element required for operation at high frequency is the use of fine geometry leads. Fine geometry leads are not as robust, and it is possible to exceed the yield or tensile strength even with small hand tools. Even though firmly attached, EXTRA care in handling is essential.

Precautions:

- Check all fixtures used for assembly, lead forming, and testing, to be sure that parts are not subjected to unnecessary physical stress.
- Check that test sockets are easy to load, and not likely to torque or twist the leads.
- Be sure that the package is attached to a flat surface.
- Do not over-torque mounting screws.
- Do not use conductive gaskets or shims under the package.
- Do not use test fixtures or sockets that may produce a sharp lifting force on the leads.
- If packages must be removed after solder attach, do not pry the leads up so that the force lifting the lead from the board is also lifting the lead from the package. Use a probe to press down on the lead-to-package joint, and lift the lead when the solder is fluid.

Mounting Screws -

Product Name	Length, min	Diameter	Thread Pitch	Material	Torque, in-oz
Socket Head Cap Screw, English	1/8"	0	80	Type 316 Stainless Steel	1.0
Socket Head Cap Screw, English	1/8"	2	56	Type 316 Stainless Steel	2.0
Socket Head Cap Screw, Metric	6 mm	M1.6	0.35mm	Type 316 Stainless Steel	1.0
Socket Head Cap Screw, Metric	6 mm	M2.5	0.45mm	Type 316 Stainless Steel	2.0

1. Mounting surface should be tapped for close tolerance fit of inner to external thread
2. Mounting surface must be flat
3. Excessive bending or deformation of the package during mounting is likely to damage the ceramic. To avoid this:
 - Insert all mounting screws for a given package and tighten all finger tight.
 - Begin tightening screws on opposite corners of the package to 1/3 torque
 - Tighten following same screw position pattern to 2/3 torque
 - Tighten following same screw position pattern to full torque
4. The use of ground or thermal pads under the package is NOT recommended.

Ordering Information

Part Number for Ordering

XP1006-FA-0N00
XP1006-FA-EV1

Description

Nickel/Gold plated RoHS compliant 10L flange package in bulk quantity
XP1006-FA Evaluation Module