



Preliminary

GENERAL DESCRIPTION

The EMPER032 is a single-chip LS1 CMOS calculator for 10-digit 1 memory, and up to 32 sets replay memory capacity which is useful for checking calculation process. Besides, the EMPER032 is an arithmetic four standard types of general function (+, -, ×, ÷), TAX function, Euro exchange, percentage calculation functions, leading zero and trailing zero suppression, chain calculations, MU calculation, Auto Power OFF available, 10-digit LCD display. Dual power supply operation, wide operating voltage and lower power consumption make it suitable for 1.5 solar battery operated calculator.

FEATURES

- Number of display 10 digits of data, (including punctuation in each digit.) 1-digit of floating minus sign, memory load, error symbol, 3-digits of commas for thousands, TAX symbol, currency exchange symbol and 3 digits for replay function, "CORRECT", "INS", "DEL", "%", "GT", sing of four general functions (+, -, ×, ÷), etc., up to the min 31 symbols in 10 digit with replay function.
- Operation methods By algebraic operation.
- Basic operations Four function, repeat multiplication and division, mixed calculation, square calculation, percentage calculation, percent discount and add-on / discount calculation, memory calculation, add-mode calculation, mark-up / down calculation, Grand total calculation, constant calculation, tax calculation, EURO exchange, square root calculation, check, insert, and correct functions.
- Decimal point method Decimal set lock key controls output format. Fixed decimal setting ("0", "1", "2", "3", "4", "6"), full floating decimal, and ADD mode (selectable with a switch).
- Contents of operation
 1. Floating point mode during operation and key entry that specified only Addition and Subtraction.
 2. Specified decimal point mode is valid only for operation results.
 3. Round-off when most significant digits have higher priority or at auto shift of rough estimation.



Preliminary

- Key rollover method
 - Error detect display
 - Protection
 - Auto power off function
 - Clock source
 - Others
- Two-key rollover
1. Key entry exceeding the number of display digits is invalid, but does not cause an error.
 2. If the integer part of an operation result exceeds the number of display digits, a rough estimate is displayed.
 3. In the overflow condition, all key except “C”, “C/CE”, “CE”, “→” key are inoperative.
1. In the overflow condition, all key except “C”, “C/CE”, “CE”, “→” key are inoperative.
 2. Key chatter protection.
 3. Auto-clear at power on
Auto-clear functions by connecting a capacitor to the RESET pin.
1. 6 minutes
1. Oscillator / clock generator internal to chip.
 1. Keyboard encoding internal to chip.
 2. Wide supply voltage range (1.2 to 1.8V).
 3. Very low power consumption.
 4. Battery / solar power supply.
 5. Symbol blinking available.
 6. Rate will be kept after AC key pressed.



Preliminary

PIN DESCRIPTIONS

SYMBOL	I/O	FUNCTION
COM1~3	O	LCD Common signal output.
A1 ~ A3	O	LCD Segment signal output and strobe output for switch status.
A4 ~ A15	O	LCD Segment signal output.
B1 ~ B3	O	LCD Segment signal output and strobe output for switch status.
B4 ~ B15	O	LCD Segment signal output.
C1 ~ C2	O	LCD Segment signal output and strobe output for switch status.
C3 ~ C15	O	LCD Segment signal output.
VDD,VSS	---	Positive and negative power supply pin.
VA,VB	---	Voltage doubler for LCD, connects a capacitor (0.1uF) between both pins.
VEE	---	LCD voltage from voltage doubler, connects a capacitor (0.1uF) to pin VDD.
TS1	I	Test pin input, be opened.
RESET	I	System reset / AC key input. (built-in schmitt trigger for debouncing)
K0 ~ K2	O	Keyboard polling signal output pins.
K3 ~ K7	I/O	Keyboard polling signal output and strobe input pins.
K8 ~ K10	I	Keyboard strobe input pins.
K11~K14	I	Switch status strobe input pins.



Preliminary

Function Descriptions

A). Operation Characteristics

- Constant Operation

The EMPCR032 has implied constant mode on +, -, \times , \div , and % operations. The constant is performed automatically by the "=" key, "%" key, or "%%" key without a constant for addition and division while the first operand is the constant for multiplication.

- Number Entry

Numericals can be entered up to 10 digit.

- Memory Protection

In any error detection, the memory contents present before the error detection are protected.

- Memory Indication

If the memory contents are a number other than zero, "M" is indicated in the sign-digit position.

B). Keyboard Description

- Equal Key (=)

- i). Performs Keyed-in operation and maintains that operation for possible use.
- ii). Establishes power/reciprocation calculation.

- Multiplication Key (\times)

- i). Enters multiplicand.
- ii). Performs previous operation and displays result.

- Division Key (\div)

- i). Enters dividend.
- ii). Performs previous operation and displays result.

- Addition Key (+)

- i). Conditions machine for an addition.
- ii). Performs previous operation and displays result.

- Subtraction Key (-)

- i). Conditions machine for a subtraction.
- ii). Performs previous operation and displays result.

- Square Root Key ($\sqrt{\quad}$)

Extract the square root of a positive numeric displayed in the entry register.

- Mark-up Key (MU)

Execute add-on calculation by A (MU) B (=) or discount calculation by A (MU) B (+/-) (=).



Preliminary

- **Percent Key (%)**

The purpose of the percent key is to allow for calculation of add-on and discount. Determination of add-on requires the principal amount to be the first entry followed by the "+" or "×" key, with the percentage being the second entry. Depression of the percent key yields the amount to add on, such as tax or interest. Depression of the "=" key adds this amount to the principal.
- **Change Sign Key (+/-)**

Pushing the "+/-" key twice in succession causes the corresponding sign to appear and disappear. During digit entry, this function changes the sign of the entered factor.
- **Clear Key (C/ON)**

During the digit entry, the first depression will clear all except memory contents.
- **Clear Entry Key (CE)**

During the digit entry will clear the entry register and display number "0".
- **Clear Key (CE/C/ON)**
 - i). First pressed as CE key.
 - ii). Second pressed as C key.
- **Memory Plus Key (M+)**
 - i). Adds the current display to the contents of memory.
 - ii). It will terminate a number entry.
- **Memory Minus Key (M-)**
 - i). Subtracts the current display from the contents of memory
 - ii). It will terminate a number entry.
- **Clear Memory Key (CM)**
 - i). Recall and clear the contents of memory.
 - ii). The recalled number is displayed and printed without rounding.
- **Recall Memory Key (RM)**

Recall the contents of memory and memory is kept. The recalled number is displayed and printed without rounding or zero suppress.
- **Recall and Clear Memory Key (RCM)**
 - i). First pressed as RM key.
 - ii). Second pressed as CM key.
- **Number, Decimal Key ("000", "00", "0 – 9", "•")**

The first number key in a sequence will clear the display and enter the digit in the display. Successive entries will shift the display left and enters the data in display register. The first decimal point entered is effective. An attempted entry of more than 10 digits decimal places will be ignored.





Preliminary

- Shift Key (→)
Delete the rightest digit and others will shift to right.
- Off Key (OFF)
Turn off the power.
- Recall and Clear GT Memory Key (RCGT) or Recall and Clear Memory II Key (RCMII)
 - i). First pressed as RGT (RMII) key, transfers the contents of the GT memory register (memory II) into the display register.
 - ii). Second pressed as CGT (CMII) key, clear the GT memory (memory II).
- Grand Total Plus Key (GT+) or Memory II Plus Key (MII+)
Add the current display to the content of grand total memory (memory II).
- Grand Total Minus Key (GT-) or Memory Minus Key (MII-)
Substrate the current display from the content of grand total memory (memory II), GT- (MII-) will terminate a number entry.
- TAX-including Key (TAX+)
 - i). Execute TAX-including calculation of displayed number, TAX rate is in TAX memory.
 - ii). In the halfway of four rules of arithmetic, TAX-including calculation don't break the intermediate result, so TAX-including is used in expression.
 - iii). When immediately after [RATE] key, store displayed number in TAX memory.
- TAX-excluding Key (TAX-)
 - i). Execute TAX-excluding calculation of displayed number, TAX rate is in TAX memory.
 - ii). In the halfway of four rules of arithmetic, TAX-excluding calculation don't break the intermediate result, so TAX-excluding is used in expression.
- EURO-conversion Key (EURO)
 - i). Execute EURO-conversion of displayed number, conversion rate is in EURO memory.
 - ii). In the halfway of four rules of arithmetic, EURO-conversion don't break the intermediate result, so EURO-conversion is used in expression.
 - iii). When immediately after [Rate], [C], [C/CE] key or reset or power on, no operation.
- Local-conversion Key (LOCAL)
 - i). Execute Local-conversion of displayed number, conversion rate is in EURO memory.
 - ii). In the halfway of four rules of arithmetic, Local-conversion don't break the intermediate result, so Local-conversion is used in expression.
 - iii). When immediately after [RATE] key, store displayed number in EURO memory.



Preliminary

- Auto play Key (A-PLAY)
Show the next item automatically until the end of Replay memory or [A-PLAY] key is pressed once
more.
-  Key (UP)
 - i). In not Replay mode, show the top item of replay memory.
 - ii). In Replay mode, show the next item of displayed item.
-  Key (DOWN)
 - i). In not Replay mode, show the bottom item of replay memory.
 - ii). In Replay mode, show the previous item of displayed item.
- Correct Key (COR)
 - i). In Replay mode, enter Correct mode of displayed item.
 - ii). In Correct mode, Fixed the entered item and return to the Replay mode.
- Insert Key (INS)
In Replay mode, insert one item before the displayed item and enter Correct mode.
- Delete Key (DEL)
In Replay mode, delete the displayed item and show the next item.
- Smart-Check Key (S-CHECK)
Enter or exit the Smart-Check mode.
- Previous/Now Key (PRE/NOW)
In Smart-Check mode and entry error, show the previous item or current item.



Preliminary

Selection Mode Switch Functions

10-digit modes depend on selectable switch. Fixed/floating decimal point mode and ADD2 mode are selected by rounding switch. The rounding switch should be so composed that either one of 6, 4, 3, 2, 1, 0, ADD2 is selected.

- Fixed "F" mode

When TAB "F" is selected, both entered numbers and calculation results follow to floating decimal point system.

- DP $i=0, 1, 2, 3, 4, 6$ mode

The calculation results follow to fixed decimal point system and $i + 1$ decimal place is counted by "CUT", "5/4".

- ADD2 mode

When "+" and "-" operation are performed after a number except decimal point is entered. The calculation is executed as $1/100$ value of number being entered.

- Fixed "CUT" mode

The number of $i + 1$ decimal position is counted as cutting away.

- Fix "5/4" mode

When a number of $i + 1$ decimal position is more than 0.5, the number of i decimal position is counted as added to "1".

- GT mode

Σ :Grand Total enable.

$\bar{\Sigma}$:Grand Total disable.



Preliminary

Error Conditions

(a) Error Detection

System errors occur when:

- i) The division by zero.
- ii) The integral part of any memory calculation results exceeds 10 digits.
- iii) Rough estimate calculation error.
- iv) The integral part of any calculation-four standard function, %, or power calculation result exceeds 10 digits.

(b) Error Indication

- i) System error.
- ii) Rough estimate calculation error
- iii) The high-order 10 digits of any calculation result is indicated with "E" sign and the decimal point is displayed at the position corresponding to 10^{-10} of the calculation result also on zero shift is performed.

(c) Error Release

A system error can be released by depressing ON/AC key or CE/C key. However, the calculation result is not cleared by CE/C key but is retained.

Overflow Condition

- (1) When the integer part of result exceed 10 digits, the display will show 10 most significant digits of result divide by " 10^{+10} " and "E".
- (2) When an overflow occurs on the way of add-on/discount calculation, display will show a zero and "E".
- (3) When the integer part of result exceeds 10 digits, display will show a zero and "E".
- (4) When division by zero is attempted, an overflow condition will result, and error symbol "E" and a zero are displayed.
- (5) When the integer part of result in memory register exceeds 10 digits at memory calculation, display will show a zero and "E", and previous data will be kept in memory register.
- (6) In overflow condition, any operation or numeral entry will be inhibited.

Preliminary

CONNECTION OF LCD

LCD Segment :

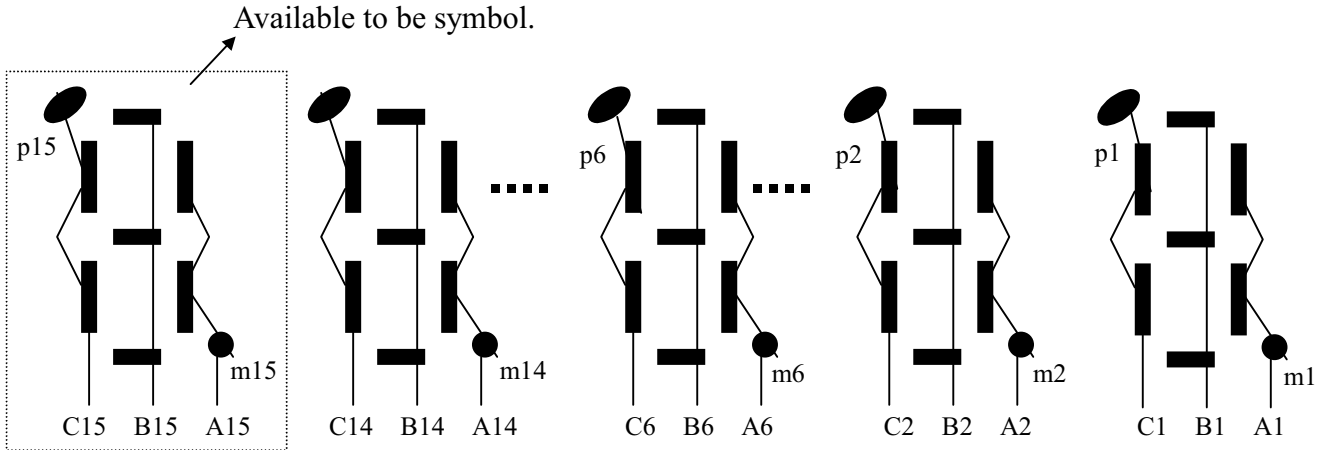

LCD Common :

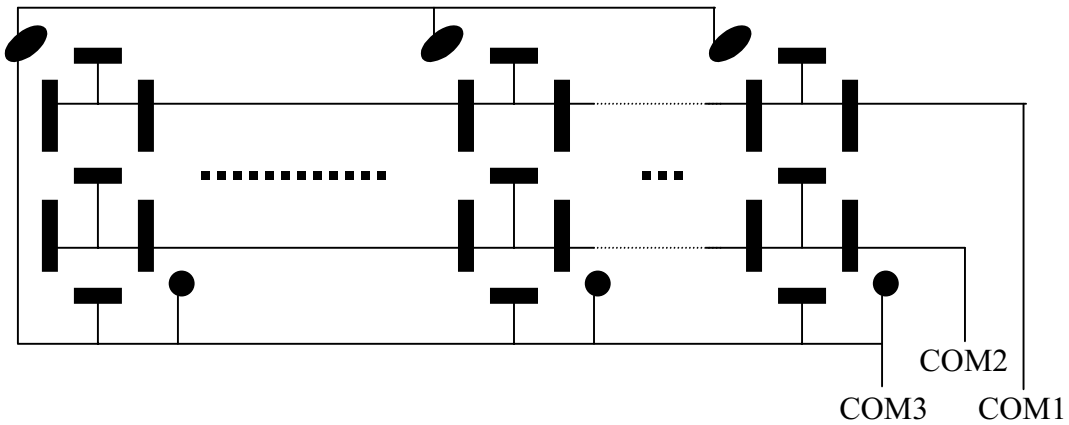

LCD Pin out :

COM1	COM2	COM3	A1	B1	C1	...	A7	B7	C7	A8	B8	C8	...	A15	B15	C15
------	------	------	----	----	----	-----	----	----	----	----	----	----	-----	-----	-----	-----



Preliminary

LCD Table:

SEG				A1	B1	C1	A2	B2	C2	A3	B3	C3
COM1	COM1			b1	a1	f1	b2	a2	f2	b3	a3	f3
COM2		COM2		c1	g1	e1	c2	g2	e2	c3	g3	e3
COM3			COM3	m1	d1	p1	m2	d2	p2	m3	d3	p3

SEG	A4	B4	C4	A5	B5	C5	A6	B6	C6	A7	B7	C7
COM1	b4	a4	f4	b5	a5	f5	b6	a6	f6	b7	a7	f7
COM2	c4	g4	e4	c5	g5	e5	c6	g6	e6	c7	g7	e7
COM3	m4	d4	p4	m5	d5	p5	m6	d6	p6	m7	d7	p7

SEG	A8	B8	C8	A9	B9	C9	A10	B10	C10	A11	B11	C11
COM1	b8	a8	f8	b9	a9	f9	b10	a10	f10	b11	a11	f11
COM2	c8	g8	e8	c9	g9	e9	c10	g10	e10	c11	g11	e11
COM3	m8	d8	p8	m9	d9	p9	m10	d10	p10	m11	d11	p11

SEG	A12	B12	C12	A13	B13	C13	A14	B14	C14	A15	B15	C15
COM1	b12	a12	f12	+	-	×	OK	×	NOW	MI	a15	-TAX
COM2	c12	g12	e12	÷	=	%	PRE	CHECK	Replay	- (sign)	G(MII)	+TAX
COM3	m12	d12	p12	MU	ANS	EURO	Correct	INS	LOCAL	E	TAX%	RATE

LCD FUNCTION DESCRIPTIONS :

“m” : mantissa. “p” : punctuation for thousand. “A”, “B”, ”C” : 7 segment of digit.

Digit display: 13th ~ 15th digit for 10 digit calculation, 11th ~ 12th digit for step counter, others are available for symbols / icons display.

LCD :

Voltage : 3V.

Driving : 1/2 bias, 1/3 duty.

Preliminary

CONNECTION OF KEYBOARD

- Keyboard arrangement

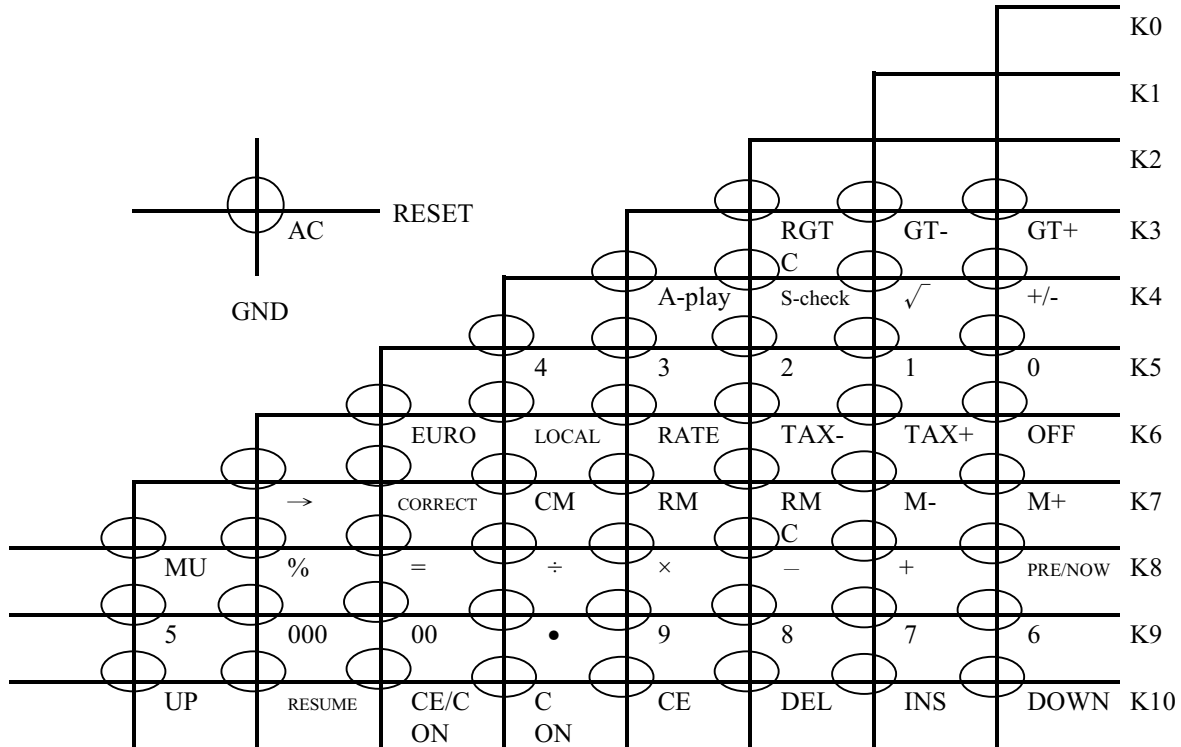

- Connection of switch

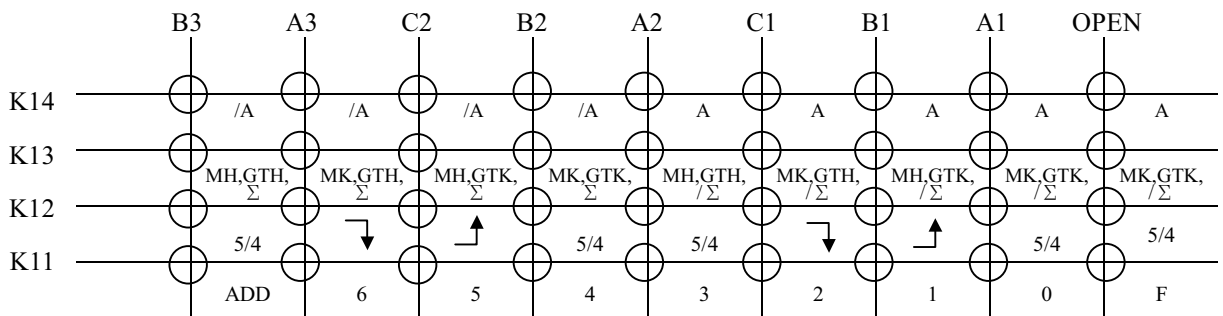

K14 : Select with Auto Power OFF mode.

K13 : Select with Memory Hold Status, MH (Memory Hold), MK (Memory Kill), GTH(GT Memory Hold) and GTX (GT Memory Kill) and total switch.

K12 : Rounding switches.

K11 : Select with Fixed point or floating mode.

Remark : 1. Initial preliminary key mapping. It may change mapping in future.

2. Σ :GT enable. $/\Sigma$:GT disable.



Preliminary

If the following switches are not shown in an explanation, set as shown :

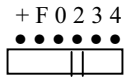

	CALCULATION	OPERATION	DISPLAY
+	3-5=-2	3 [-] 5 [=]	01 3. + 03 - 2.00 =
	(-2)×3=-6	C [-] × 2 3 [=]	01 0. - 02 - 2. × 04 - 6.00 =
-	(-365) ÷7=-52.14	C [-] ÷ 365 7 [=]	01 0. - 02 - 365. ÷ 04 - 52.14 =
×	300×2,145=643,500	300 × 2145 [=]	01 300. × 03 643'500.00 =
	300×4,950.6=1,485,180	4950 .6 [=]	06 1'485'180.00 =
÷	31,750÷500=63.50	31750 ÷ 500 [=]	01 31'750. ÷ 03 63.50 =
	54,236÷500=108.47	54236 [=]	06 108.47 =
X ⁿ	3 ³ =27	3 × [=] (3 ²) [=] (3 ³)	01 3. × 03 9.00 = 04 27.00 =
	1/4=0.25	4 ÷ [=]	01 4. ÷ 03 0.25 =
	123×456=56,088	123 × 756 [CE] 456 [=]	01 123. × 02 456. 03 56'088.00 =
%	2,350× ¹⁷ / ₁₀₀ =399.50	2350 × 17 %	01 2'350. × 03 399.50 %
	⁴⁵⁶ / ₇₈₉ ×100=57.79	456 ÷ 789 %	01 456. ÷ 03 57.79 %
%	2,000+(2,000× ¹² / ₁₀₀) =2,240	2000 × 12 % + [=]	01 2'000. × 03 240.00 % 04 240. + 06 2'240.00 =
	2,000-(2,000× ¹² / ₁₀₀) =1,760	2000 × 12 % - [=]	01 2'000. × 03 240.00 % 04 240. - 06 1' 760.00 =



Preliminary

	CALCULATION	OPERATION	DISPLAY
<div style="border: 1px solid black; padding: 2px; width: fit-content; margin: 2px;">M⁺</div> <div style="border: 1px solid black; padding: 2px; width: fit-content; margin: 2px;">M⁻</div> <div style="border: 1px solid black; padding: 2px; width: fit-content; margin: 2px;">RM</div> <div style="border: 1px solid black; padding: 2px; width: fit-content; margin: 2px;">CM</div>	$243 \times 12 = 2,916$ $576 \times 25 = 14,400$ $17,316$ $-) 456 \times 32 = 14,592$ $2,724$	(CM) 243 × 12 M⁺ 576 × 25 M⁺ 456 RM 32 × M⁻ CM	01 243. × 03 ^M 2'916.00 = 04 ^M 576. × 06 ^M 14'400.00 = 07 ^M 17'316.00 07 ^M 456. × 09 ^M 14'592.00 = 09 14'592.00 =
<div style="border: 1px solid black; padding: 2px; width: fit-content; margin: 2px;">MU</div>	$200 \div (1 - 20/100) = 250$	200 MU 20 % =	01 200. MU 03 250.00 % 04 50.00 =
<div style="border: 1px solid black; padding: 2px; width: fit-content; margin: 2px;">√</div>	$\sqrt{25} = 5$ $10 \times \sqrt{9} \div 2 = 15$	25 √ 10 × 9 √ ÷ 2 =	01 25. 01 5. 01 10. × 02 3. 02 30. ÷ 04 15.00 =
<div style="border: 1px solid black; padding: 2px; width: fit-content; margin: 2px;">GT</div>	$100 + 200 + 300 = 600$ ① $+) 300 + 400 + 500 = 1200$ ② $+) 500 - 600 + 700 = 600$ ③ $\text{Grand Total} = 2400$ ④ <div style="text-align: center; margin: 10px 0;"> <div style="border: 1px solid black; width: 60px; height: 20px; margin: 0 auto; position: relative;"> <div style="position: absolute; left: 50%; top: 50%; transform: translate(-50%, -50%);"> GT OFF ON </div> </div> <p style="margin: 5px 0;">+ F 0 2 3</p> <div style="border: 1px solid black; width: 60px; height: 20px; margin: 0 auto; position: relative;"> <div style="position: absolute; left: 50%; top: 50%; transform: translate(-50%, -50%);"> GT </div> </div> </div>	100 + 200 + 300 = 300 + 400 + 500 = 500 - 600 + 700 = GT GT	01 100. + 02 300. + 04 GT 600.00 = 05 GT 300. + 06 GT 700. + 08 GT 1'200.00 = 09 GT 500. - 10 GT -100. + 12 GT 600.00 = 13 GT 2'400.00 13 2'400.00



Preliminary

	CALCULATION	OPERATION	DISPLAY
RATE	SET RATE	5	01 5. > RATE
			01 5. RATE
TAX+	RECALL RATE	RATE	01 5. RATE
	TAX+	800	01 800.
	= net price × 1.05		01 840.00 TAX+
	= 800 × 1.05		01 40.00 TAX
TAX-			01 840.00 TAX+
	TAX-	840	01 840.
	= price(including TAX)		01 800.00 TAX-
	÷ 1.05		01 40.00 TAX
			01 800.00 TAX-
RATE	SET RATE	1.234567	01 1.234567 > RATE
			01 1.23456 RATE
LOCAL	RECALL RATE	RATE	01 1.23456 RATE
	1,000 × 1.23456	1000	01 1,000.
			01 1'234.56 LOCAL
			01 1'234.56 LOCAL
EURO			01 1,000.00 EURO
	1,000 ÷ 1.23456	1,000	01 1,000.
			01 810.01 EURO
			01 810.01 EURO
			01 1,000.00 LOCAL



Preliminary

CALCULATION	OPERATION	DISPLAY
REPLAY : $(500+400-80) \times 3 = 2460$	500 $\boxed{+}$ 400 $\boxed{-}$ 80 $\boxed{\times}$ 3 $\boxed{=}$ $\boxed{\Delta}$ $\boxed{\Delta}$ $\boxed{\Delta}$ $\boxed{\Delta}$ $\boxed{\Delta}$ $\boxed{\nabla}$ $\boxed{\nabla}$ $\boxed{\nabla}$ $\boxed{\nabla}$ $\boxed{\nabla}$	01 500. 01 500. + 02 400. 02 900. - 03 80. 03 820. × 04 3. 05 2'460. = REPLAY 01 500. + REPLAY 02 400. - REPLAY 03 80. × REPLAY 04 3. = REPLAY 05 2'460. ANS REPLAY 04 3. = REPLAY 03 80. × REPLAY 02 400. - REPLAY 01 500. + REPLAY 05 2'460. ANS
CORRECT : $(500+400-80) \times 3 = 2460$ → CORRECT 100+ $(500+100+80) \times 3 = 2040$	500 $\boxed{+}$ 400 $\boxed{-}$ 80 $\boxed{\times}$ 3 $\boxed{=}$ $\boxed{\Delta}$ $\boxed{\Delta}$ CORRECT 100 $\boxed{+}$ CORRECT $\boxed{\Delta}$ $\boxed{\Delta}$ $\boxed{\Delta}$	REPLAY 05 2'460. = REPLAY 02 400. - REPLAY CORRECT 02 400. - REPLAY CORRECT 02 100. - REPLAY CORRECT 02 100. + REPLAY CORRECT 02 100. + REPLAY 03 80. × REPLAY 04 3. = REPLAY 05 2'040. ANS
INSERT : $(500+400-80) \times 3 = 2460$ → INSERT 6÷ $(500+400-80) \times 6 \div 3 = 1640$	500 $\boxed{+}$ 400 $\boxed{-}$ 80 $\boxed{\times}$ 3 $\boxed{=}$ $\boxed{\nabla}$ $\boxed{\nabla}$ INSERT 6 $\boxed{\div}$ CORRECT $\boxed{\Delta}$ $\boxed{\Delta}$	REPLAY 05 2'460. = REPLAY 04 3. = REPLAY CORRECT 04 INSERT 0. + REPLAY CORRECT 04 INSERT 6. ÷ REPLAY CORRECT 04 6. ÷ REPLAY 05 3. = REPLAY 06 1'640. ANS
DELETE : $(500+400-80) \times 3 = 2460$ → DELETE 400- $(500+80) \times 3 = 1740$	500 $\boxed{+}$ 400 $\boxed{-}$ 80 $\boxed{\times}$ 3 $\boxed{=}$ $\boxed{\Delta}$ $\boxed{\Delta}$ DELETE $\boxed{\Delta}$ $\boxed{\Delta}$	REPLAY 05 2'460. = REPLAY 02 400. - REPLAY 02 80. × REPLAY 03 3. = REPLAY 04 1'740. ANS

* This specification are subject to be changed without notice.



Preliminary

CALCULATION	OPERATION	DISPLAY
SMART CHECK :	500 <input type="button" value="+"/> 400 <input type="button" value="-"/> 80 <input type="button" value="x"/> 3 <input type="button" value="="/>	05 2'460. =
	<input type="button" value="S-CHECK"/>	CHECK 00 0.
	1 <input type="button" value="+"/>	CHECK 01 1. +
	2 <input type="button" value="+"/>	CHECK 02 3. +
	3 <input type="button" value="+"/>	CHECK 03 6. +
	4 <input type="button" value="+"/>	CHECK 04 10. +
	5 <input type="button" value="="/>	CHECK 06 15. =
	1 <input type="button" value="+"/>	CHECK 01 1. +
	2 <input type="button" value="+"/>	CHECK 02 3. +
	5 <input type="button" value="="/>	CHECK 03 5.
	<input type="button" value="+"/>	CHECK 03 NOW x >5.< +
	<input type="button" value="PRE/NOW"/>	CHECK 03 PRE x >3.< +
	<input type="button" value="PRE/NOW"/>	CHECK 03 NOW x >5.< +
	<input type="button" value="CORRECT"/>	CHECK 03 5. +
	6 <input type="button" value="-"/>	CHECK 03 6. -
	<input type="button" value="CORRECT"/>	CHECK 03 NOW x >6. <
	<input type="button" value="PRE/NOW"/>	CHECK 03 PRE x >3. + <
	<input type="button" value="CORRECT"/>	CHECK 03 3. +
	<input type="button" value="CORRECT"/>	CHECK 03 6. +
	4 <input type="button" value="+"/>	CHECK 04 10. +
	5 <input type="button" value="="/>	CHECK 06 OK 15. =
	9 <input type="button" value="x"/>	CHECK 01 9. x
	8 <input type="button" value="+"/>	CHECK 02 72. +
	<input type="button" value="S-CHECK"/>	CHECK 00 0.



Preliminary

ABOLUTE MAXIMUM RATINGS

Items	Sym.	Min.	Max.	Unit
Supply Voltage	VDD-VSS	-0.3	2.0	V
Input Voltage	V _{IN}	-0.3	VDD+0.3	V
Operating Temperature	T _{OP}	0	50	°C
Storage Temperature	T _{STG}	-55	+125	°C

DC ELECTRICAL CHARACTERISTICS

(VDD=1.5V±0.3V, VSS=0V, TA=25 °C, VEE=3.0±0.4V)

Parameter	Pin Name	Sym.	Min.	Typ.	Max.	Unit	Condition
Operating Voltage	-	V _{DD}	1.2	1.5	1.8	V	
“1” Input Voltage	K3~K10	V _{IH} (1)	V _{DD} -0.4	-	V _{DD}	V	
“1” Input Voltage	K11~K14	V _{IH} (2)	V _{EE} -0.4	-	V _{EE}	V	
“0” Input Voltage	K3~K14	V _{IL} (1)	0	-	0.4	V	
“1” Input Voltage	RESET	V _{IH} (3)	0.6 V _{DD}	-	V _{DD}	V	VDD=1.5V
“0” Input Voltage	RESET	V _{IL} (2)	0	-	0.4 V _{DD}	V	VDD=1.5V
“1” Output Voltage	SEGMENT COM1~3	V _{OH} (1)	V _{EE} -0.2	-	V _{EE}	V	
“0” Output Voltage	SEGMENT COM1~3	V _{OL} (1)	0	-	0.2	V	
“M” Output Voltage	COM1~3	V _{OM}	V _{DD} -0.2	-	V _{DD} +0.2	V	
“1” Output Voltage	K0~K7	V _{OH} (2)	V _{DD} -0.2	-	V _{DD}	V	
“0” Output Voltage	K0~K7	V _{OL} (2)	0	-	0.2	V	
“1” Output Resistance	SEGMENT COM1~3	R _{OH}	-	-	70	KΩ	V _{OUT} = V _{EE} -0.5V
“0” Output Resistance	SEGMENT COM1~3	R _{OL}	-	-	70	KΩ	V _{OUT} = 0.5V



Preliminary

Parameter	Name	Sym.	Min.	Typ.	Max.	Unit	Condition
Key Pull Down Resistance	K0~K10	R _{KEYL} (1)	240	-	650	KΩ	V _{OUT} = V _{DD}
Key Pull Up Resistance	K0~K7	R _{KEYH} (1)	-	-	10	KΩ	V _{OUT} = 0.5V
	RESET	R _{KEYH} (2)	50	-	370	KΩ	V _{OUT} = 0.5V
Switch Pull Down Resistance	K11~K14	R _{SW} (1)	240	400	800	KΩ	V _{OUT} = V _{EE}
Oscillating Frequency	(Wait) TS1	F _{0WAIT}	15.7	22.5	29.3	KHz	
	(Operate) TS1	F _{0OP}	100	195	290	KHz	
Frame Frequency	SEGMENT COM1~3	f _F	70	117	164	Hz	
Supply Current	1 (WAIT)	I _{DDWAIT}	-	3.0	4.5	μA	V _{DD} = 1.5V
	2 (OPERATE)	I _{DDOP}	-	22	35	μA	V _{DD} = 1.5V
	3 (OFF)	I _{DDOFF}	-	-	1.0	μA	V _{DD} = 1.5V

Preliminary

APPLICATION BLOCK DIAGRAM

- Battery Type

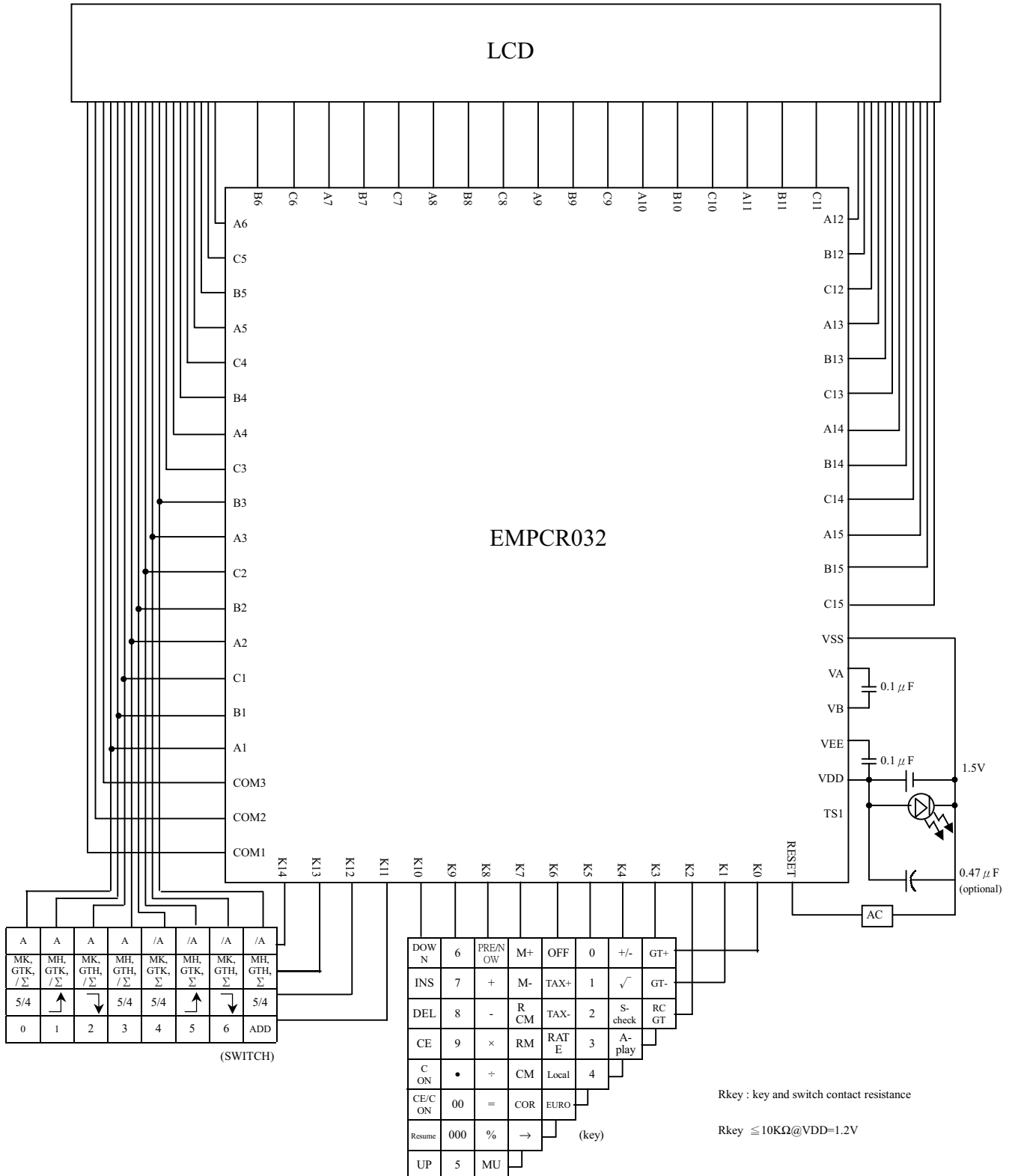

Preliminary

- Solar Type

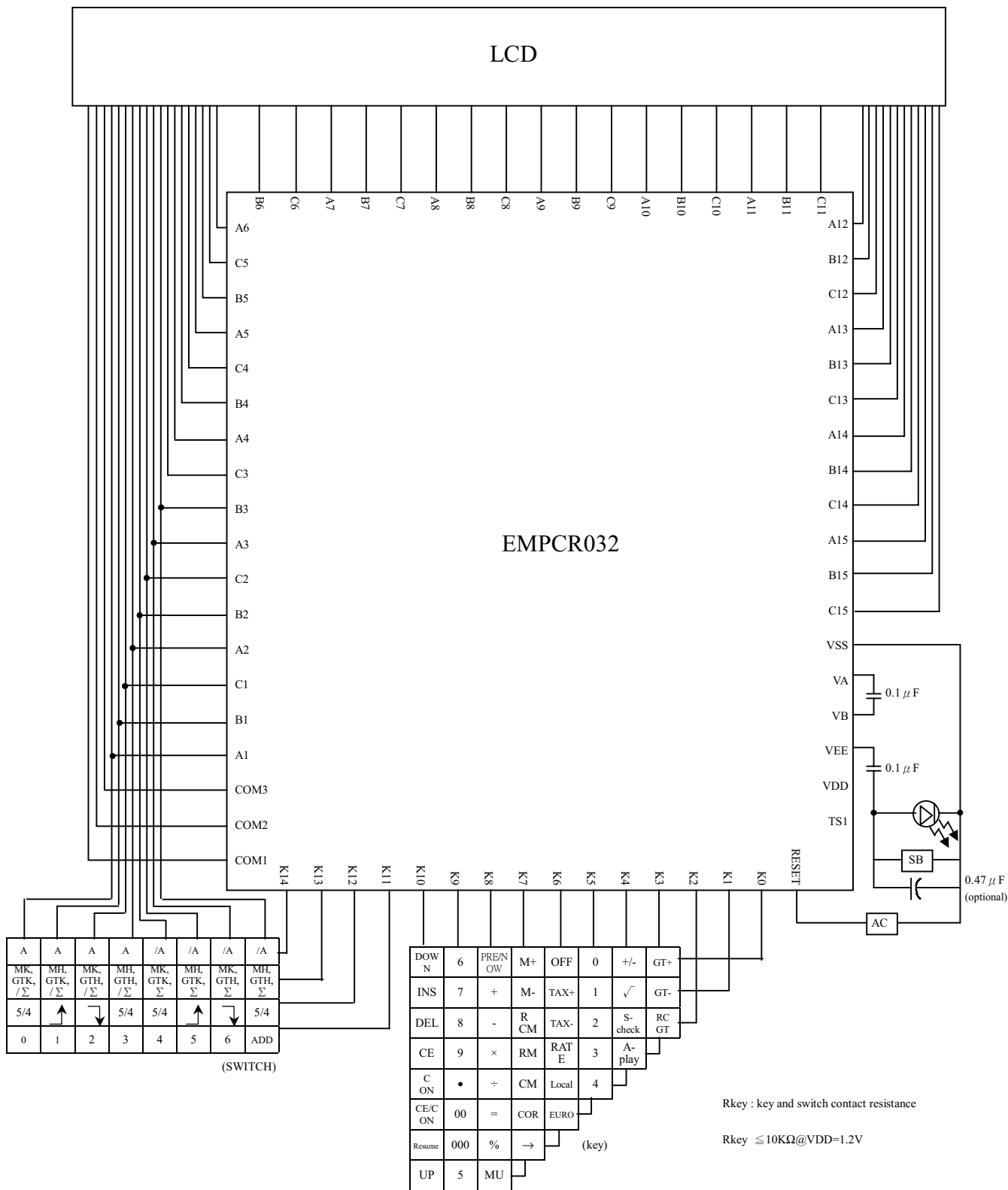

Preliminary

- Dual Type

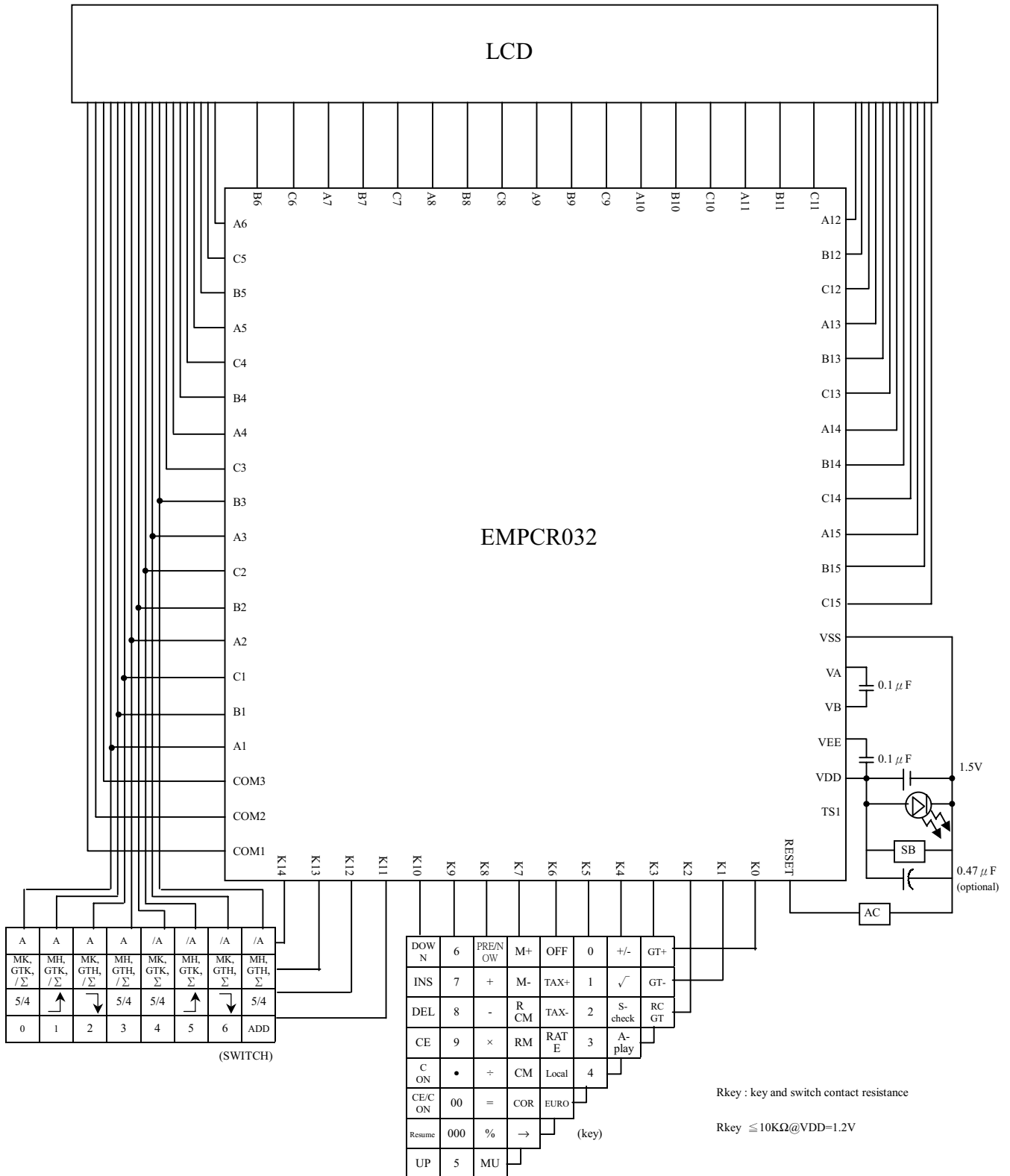



Preliminary

PAD DIAGRAM

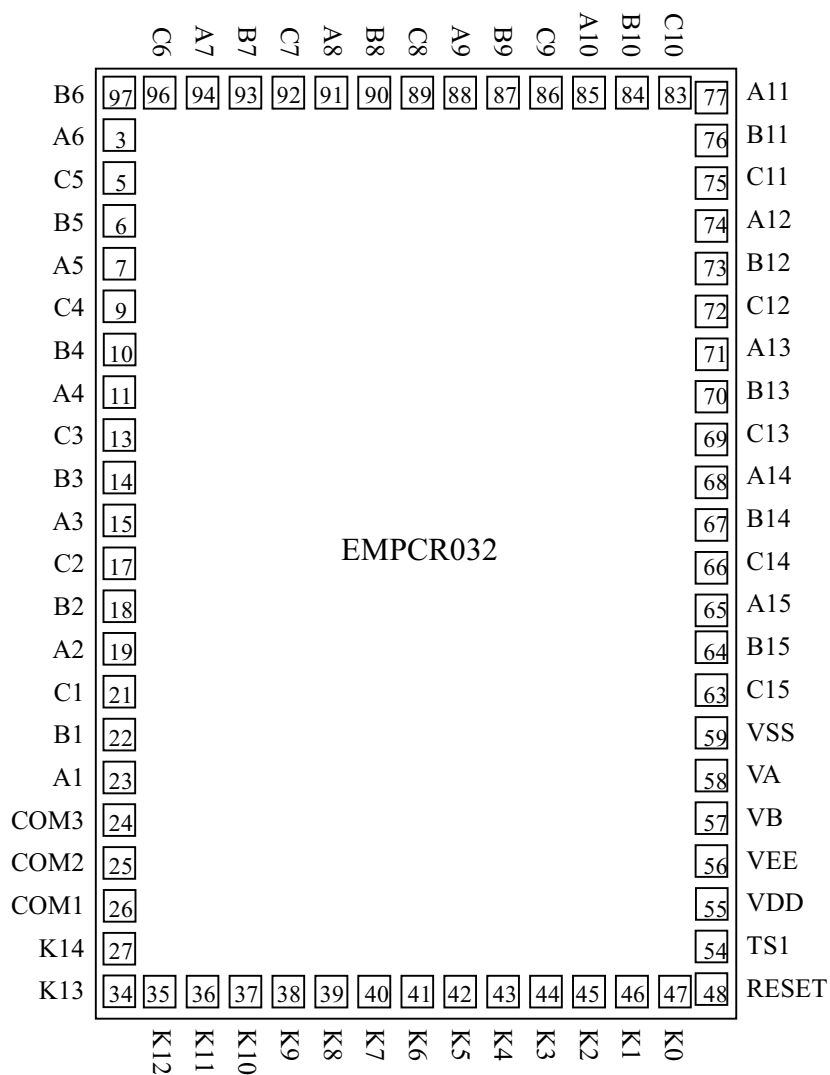



Preliminary

Pad No.	Symbol	X	Y
1	NC		
2	NC		
3	A6	-770.0	1035.0
4	NC		
5	C5	-770.0	920.0
6	B5	-770.0	805.0
7	A5	-770.0	695.0
8	NC		
9	C4	-770.0	585.0
10	B4	-770.0	475.0
11	A4	-770.0	367.5
12	NC		
13	C3	-770.0	262.5
14	B3	-770.0	157.5
15	A3	-770.0	52.5
16	NC		
17	C2	-770.0	-52.5
18	B2	-770.0	-157.5
19	A2	-770.0	-262.5
20	NC		
21	C1	-770.0	-367.5
22	B1	-770.0	-475.0
23	A1	-770.0	-585.0
24	COM3	-770.0	-695.0
25	COM2	-770.0	-805.0
26	COM1	-770.0	-920.0
27	K14	-770.0	-1035.0
28	NC		
29	NC		
30	NC		
31	NC		
32	NC		
33	NC		
34	K13	-770.0	-1160.0
35	K12	-645.0	-1160.0
36	K11	-535.0	-1160.0
37	K10	-425.0	-1160.0
38	K9	-317.5	-1160.0
39	K8	-210.0	-1160.0
40	K7	-105.0	-1160.0



Preliminary

Pad No.	Symbol	X	Y
41	K6	0.0	-1160.0
42	K5	105.0	-1160.0
43	K4	210.0	-1160.0
44	K3	317.5	-1160.0
45	K2	425.0	-1160.0
46	K1	535.0	-1160.0
47	K0	645.0	-1160.0
48	RESET	770.0	-1160.0
49	NC		
50	NC		
51	NC		
52	NC		
53	NC		
54	TS1	770.0	-1035.0
55	VDD	770.0	-920.0
56	VEE	770.0	-805.0
57	VB	770.0	-695.0
58	VA	770.0	-585.0
59	VSS	770.0	-475.0
60	NC		
61	NC		
62	NC		
63	C15	770.0	-367.5
64	B15	770.0	-262.5
65	A15	770.0	-157.5
66	C14	770.0	-52.5
67	B14	770.0	52.5
68	A14	770.0	157.5
69	C13	770.0	262.5
70	B13	770.0	367.5
71	A13	770.0	475.0
72	C12	770.0	585.0
73	B12	770.0	695.0
74	A12	770.0	805.0
75	C11	770.0	920.0
76	B11	770.0	1035.0
77	A11	770.0	1160.0
78	NC		
79	NC		
80	NC		



Preliminary

Pad No.	Symbol	X	Y
81	NC		
82	NC		
83	C10	645.0	1160.0
84	B10	535.0	1160.0
85	A10	425.0	1160.0
86	C9	317.5	1160.0
87	B9	210.0	1160.0
88	A9	105.0	1160.0
89	C8	0.0	1160.0
90	B8	-105.0	1160.0
91	A8	-210.0	1160.0
92	C7	-317.5	1160.0
93	B7	-425.0	1160.0
94	A7	-535.0	1160.0
95	NC		
96	C6	-645.0	1160.0
97	B6	-770.0	1160.0
98	NC		
99	NC		
100	NC		

Chip size:1800 x 2580 um

Note : For PCB layout, IC substrate must be connected to VSS.