

GaAs PHEMT MMIC 2 WATT POWER AMPLIFIER, 7.0 - 9.0 GHz

Typical Applications

The HMC486 is ideal for use as a power amplifier for:

- Point-to-Point Radios
- Point-to-Multi-Point Radios
- Test Equipment & Sensors
- Military End-Use
- Space

Features

- Saturated Output Power: +34 dBm @ 24% PAE
- Output IP3: +40 dBm
- Gain: 26 dB
- DC Supply: +7.0 V @ 1300 mA
- 50 Ohm Matched Input/Output
- 2.51 mm x 2.51 mm x 0.1 mm

Functional Diagram

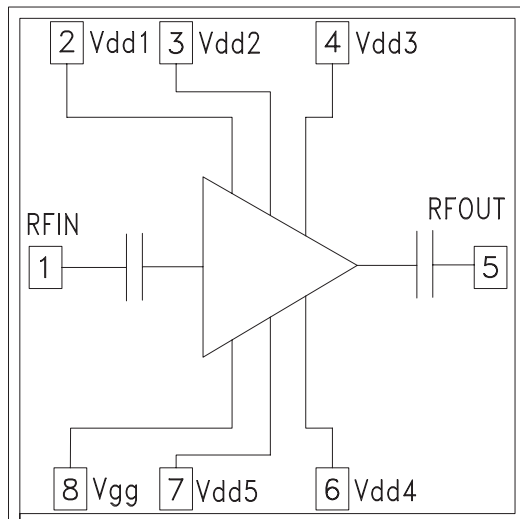

General Description

The HMC486 is a high dynamic range GaAs PHEMT MMIC 2 Watt Power Amplifier which operates from 7 to 9 GHz. This amplifier die provides 26 dB of gain, +34 dBm of saturated power and 24% PAE from a +7.0 V supply voltage. Output IP3 is +40 dBm typical. The RF I/Os are DC blocked and matched to 50 Ohms for ease of integration into Multi-Chip-Modules (MCMs). All data is taken with the chip in a 50 ohm test fixture connected via 0.025mm (1 mil) diameter wire bonds of minimal length 0.31mm (12 mils).

Electrical Specifications, $T_A = +25^\circ\text{C}$, $V_{dd} = +7\text{V}$, $I_{dd} = 1300\text{mA}^*$

Parameter	Min.	Typ.	Max.	Min.	Typ.	Max.	Units
Frequency Range	7 - 8			8 - 9			GHz
Gain	22	25		23	26		dB
Gain Variation Over Temperature		0.04	0.06		0.04	0.06	dB/°C
Input Return Loss		11			12		dB
Output Return Loss		8			6		dB
Output Power for 1 dB Compression (P1dB)	30	33		30.5	33.5		dBm
Saturated Output Power (Psat)		33.5			34		dBm
Output Third Order Intercept (IP3)		40			38		dBm
Noise Figure		6.5			7		dB
Supply Current (Idd)		1300			1300		mA

* Adjust Vgg between -2 to 0V to achieve Idd= 1300 mA typical.

**GaAs PHEMT MMIC 2 WATT
POWER AMPLIFIER, 7.0 - 9.0 GHz**

Broadband Gain & Return Loss

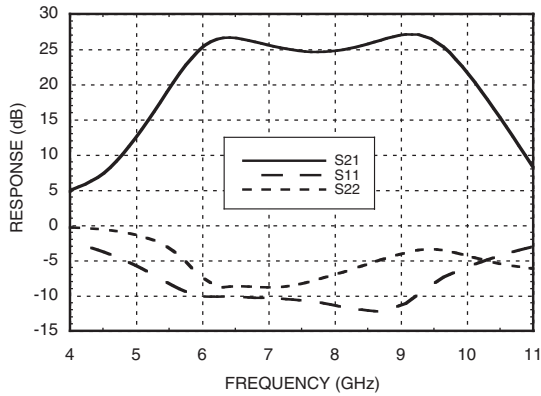

Gain vs. Temperature

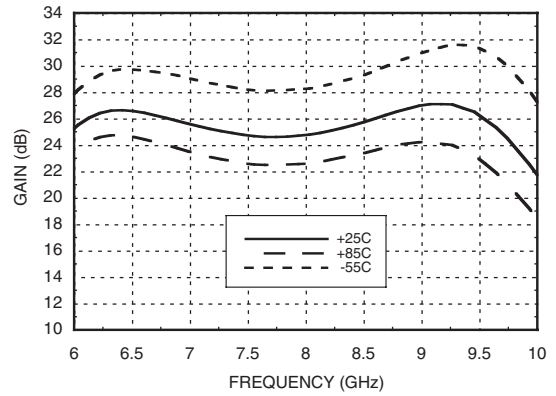

Input Return Loss vs. Temperature

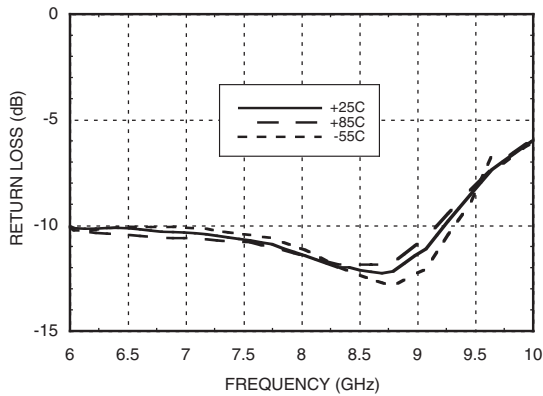

Output Return Loss vs. Temperature

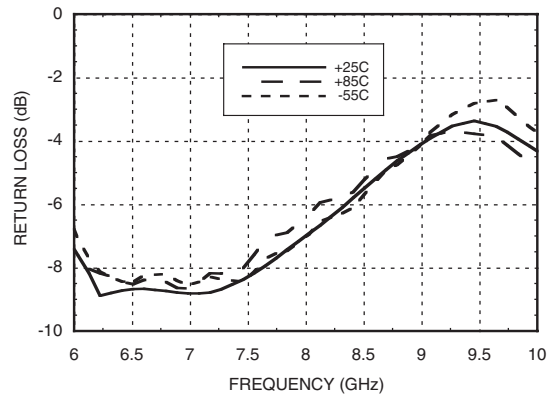

P1dB vs. Temperature

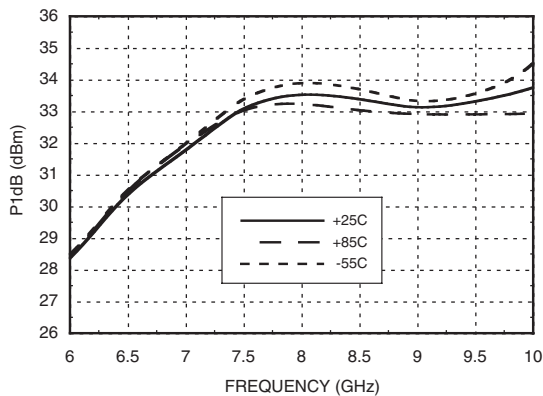

Psat vs. Temperature

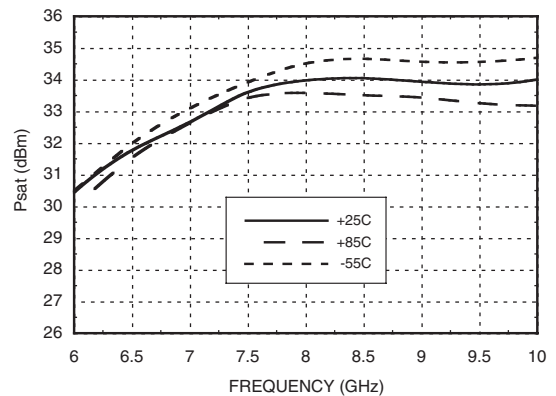

**GaAs PHEMT MMIC 2 WATT
POWER AMPLIFIER, 7.0 - 9.0 GHz**

Output IP3 vs. Temperature

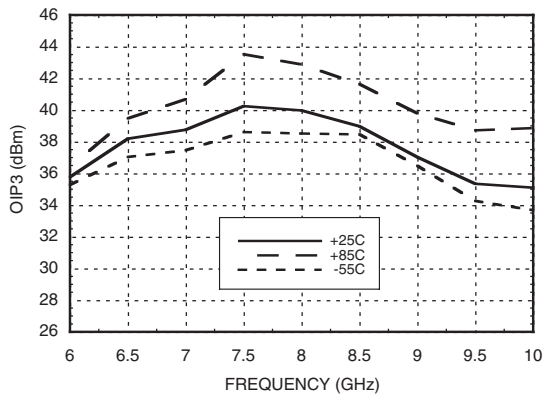

Power Compression @ 8 GHz

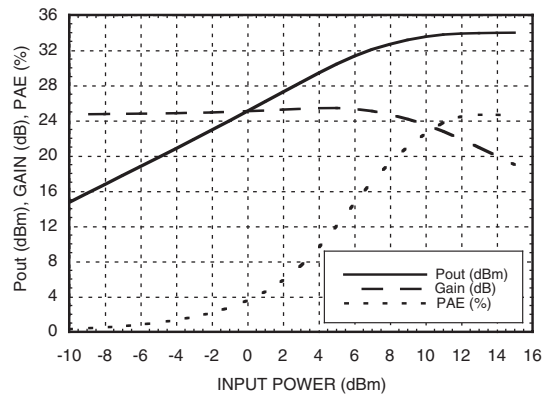

**Gain, Power & OIP3
vs. Supply Voltage @ 8 GHz**

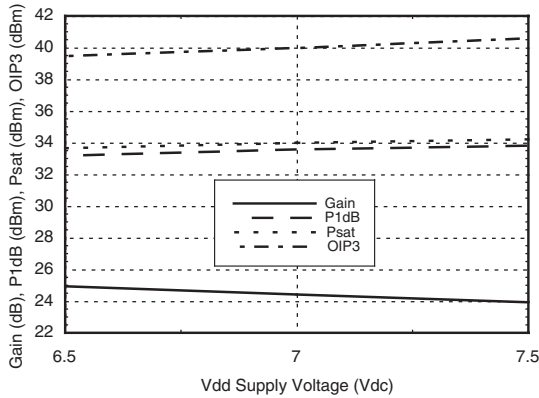

**Gain, Power & OIP3
vs. Supply Current @ 8 GHz**

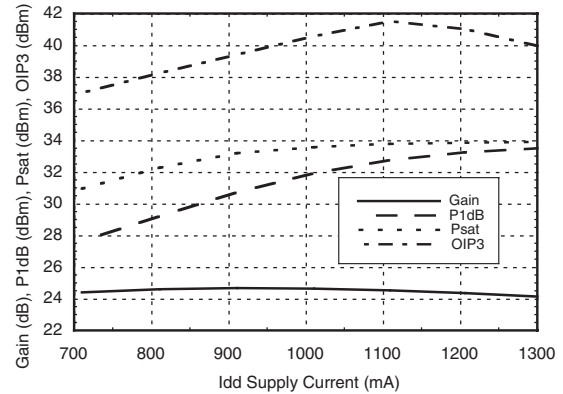

Noise Figure vs. Temperature

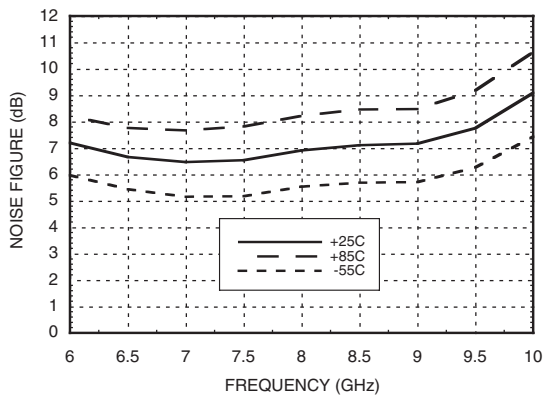

Reverse Isolation vs. Temperature

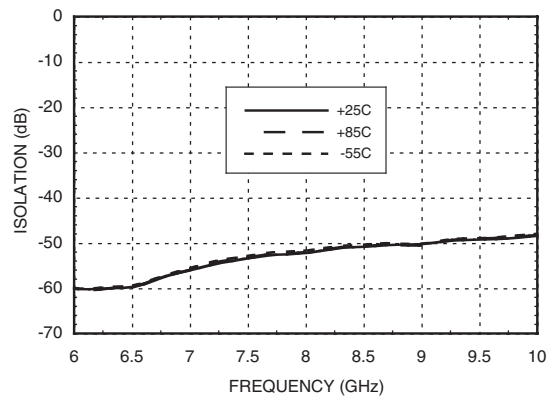

GaAs PHEMT MMIC 2 WATT POWER AMPLIFIER, 7.0 - 9.0 GHz

Power Dissipation

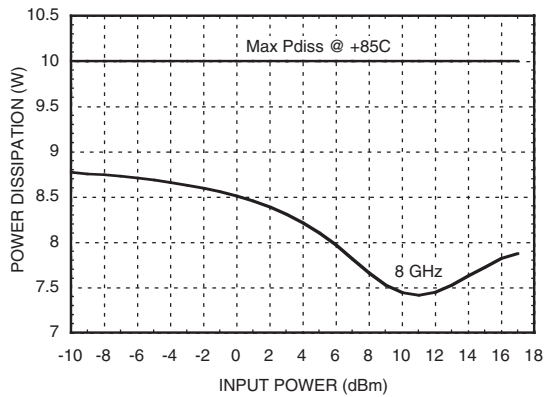

**ELECTROSTATIC SENSITIVE DEVICE
OBSERVE HANDLING PRECAUTIONS**

Absolute Maximum Ratings

Drain Bias Voltage (Vdd)	+8 Vdc
Gate Bias Voltage (Vgg)	-2.0 to 0 Vdc
RF Input Power (RFIn)(Vdd = +7.0 Vdc)	+15 dBm
Channel Temperature	175 °C
Continuous Pdiss (T= 85 °C) (derate 105 mW/°C above 85 °C)	9.45 W
Thermal Resistance (channel to die bottom)	9.5 °C/W
Storage Temperature	-65 to +150 °C
Operating Temperature	-55 to +85 °C
ESD Sensitivity (HBM)	Class 1A

Typical Supply Current vs. Vdd

Vdd (V)	Idd (mA)
+6.5	1305
+7.0	1300
+7.5	1295

Note: Amplifier will operate over full voltage ranges shown above Vgg adjusted to achieve Idd = 1300 mA at +7.0V

**GaAs PHEMT MMIC 2 WATT
POWER AMPLIFIER, 7.0 - 9.0 GHz**

1

AMPLIFIERS - CHIP

Outline Drawing

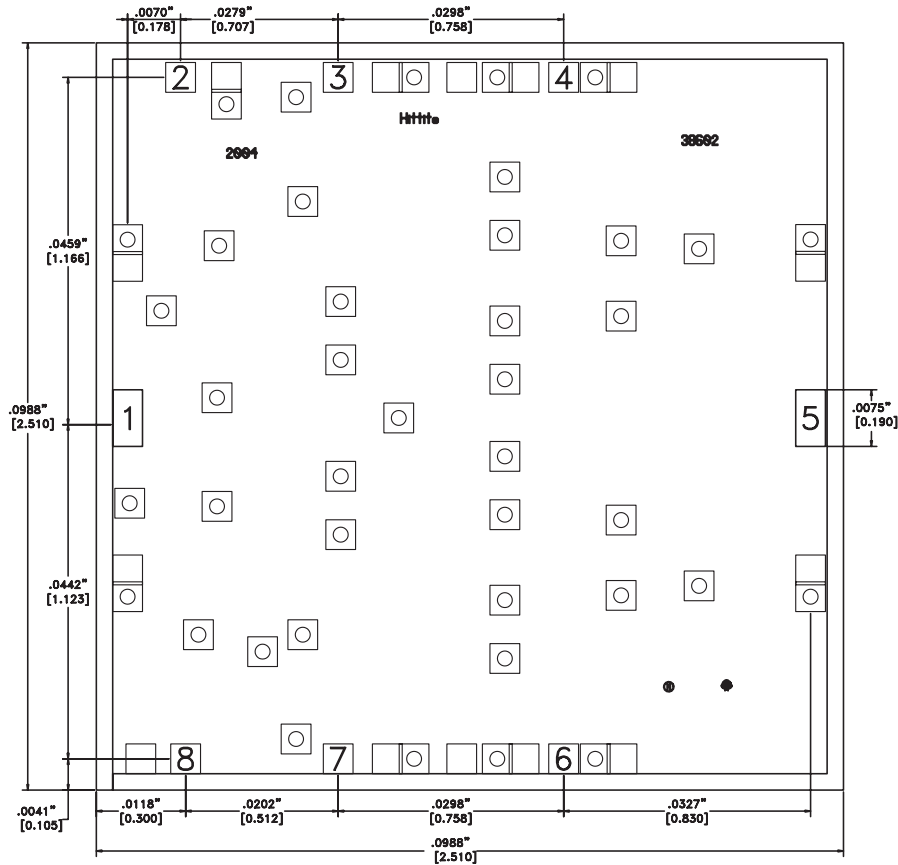

Die Packaging Information [1]

Standard	Alternate
GP-1	[2]

[1] Refer to the "Packaging Information" section for die packaging dimensions.



[2] For alternate packaging information contact Hittite Microwave Corporation.

NOTES:

1. ALL DIMENSIONS ARE IN INCHES [MM]
2. DIE THICKNESS IS .004"
3. TYPICAL BOND PAD IS .004" SQUARE
4. BACKSIDE METALLIZATION: GOLD
5. BOND PAD METALLIZATION: GOLD
6. BACKSIDE METAL IS GROUND.
7. CONNECTION NOT REQUIRED FOR UNLABELED BOND PADS.
8. OVERALL DIE SIZE ± .002

**GaAs PHEMT MMIC 2 WATT
POWER AMPLIFIER, 7.0 - 9.0 GHz**

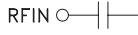
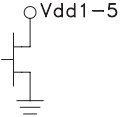
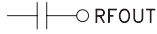
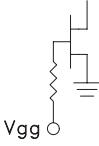
Pad Descriptions

Pad Number	Function	Description	Interface Schematic
1	RFIN	This pad is AC coupled and matched to 50 Ohms from 7 - 9 GHz.	
2 - 4, 6, 7	Vdd 1-5	Power Supply Voltage for the amplifier. External bypass capacitors of 100 pF and 0.1 μF are required.	
5	RFOUT	This pad is AC coupled and matched to 50 Ohms from 7 - 9 GHz.	
8	Vgg	Gate control for amplifier. Adjust to achieve I _{dd} of 1300 mA. Please follow "MMIC Amplifier Biasing Procedure" Application Note. External bypass capacitors of 100 pF and 0.1 μF are required.	
Die Bottom	GND	Die bottom must be connected to RF/DC ground.	

**GaAs PHEMT MMIC 2 WATT
POWER AMPLIFIER, 7.0 - 9.0 GHz**

1

AMPLIFIERS - CHIP

Assembly Diagram

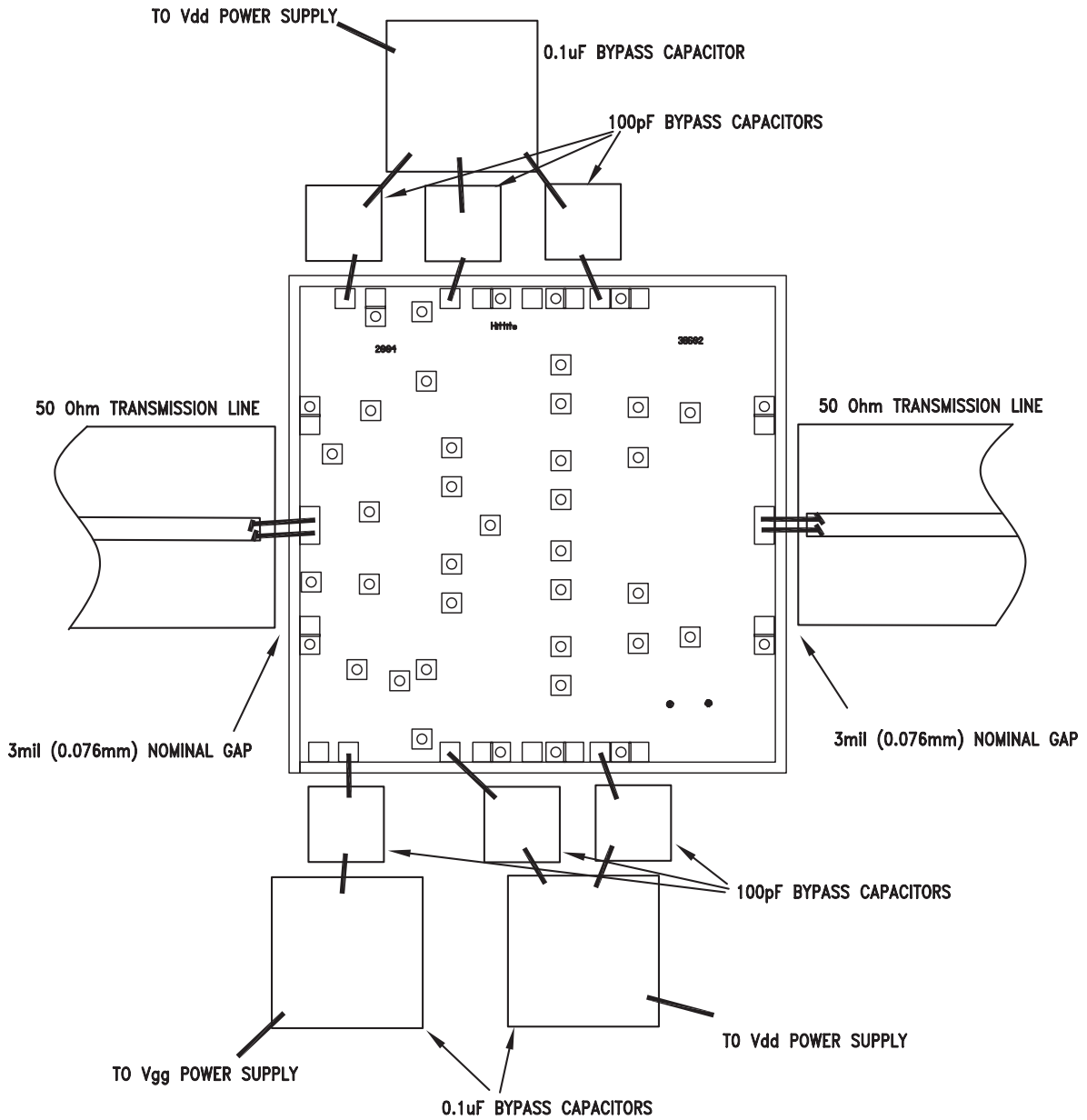

**GaAs PHEMT MMIC 2 WATT
POWER AMPLIFIER, 7.0 - 9.0 GHz**

Mounting & Bonding Techniques for Millimeterwave GaAs MMICs

The die should be attached directly to the ground plane eutectically or with conductive epoxy (see HMC general Handling, Mounting, Bonding Note).

50 Ohm Microstrip transmission lines on 0.127mm (5 mil) thick alumina thin film substrates are recommended for bringing RF to and from the chip (Figure 1). If 0.254mm (10 mil) thick alumina thin film substrates must be used, the die should be raised 0.150mm (6 mils) so that the surface of the die is coplanar with the surface of the substrate. One way to accomplish this is to attach the 0.102mm (4 mil) thick die to a 0.150mm (6 mil) thick molybdenum heat spreader (moly-tab) which is then attached to the ground plane (Figure 2).

Microstrip substrates should be located as close to the die as possible in order to minimize bond wire length. Typical die-to-substrate spacing is 0.076mm to 0.152 mm (3 to 6 mils).

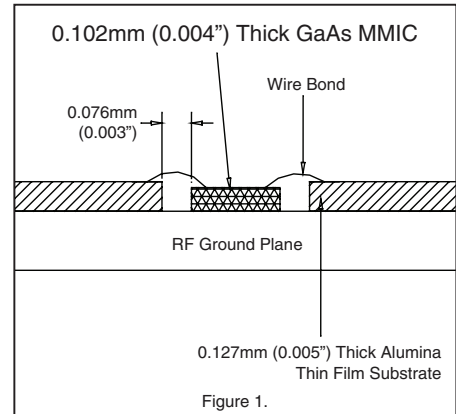

Handling Precautions

Follow these precautions to avoid permanent damage.

Storage: All bare die are placed in either Waffle or Gel based ESD protective containers, and then sealed in an ESD protective bag for shipment. Once the sealed ESD protective bag has been opened, all die should be stored in a dry nitrogen environment.

Cleanliness: Handle the chips in a clean environment. DO NOT attempt to clean the chip using liquid cleaning systems.

Static Sensitivity: Follow ESD precautions to protect against > ± 250V ESD strikes.

Transients: Suppress instrument and bias supply transients while bias is applied. Use shielded signal and bias cables to minimize inductive pick-up.

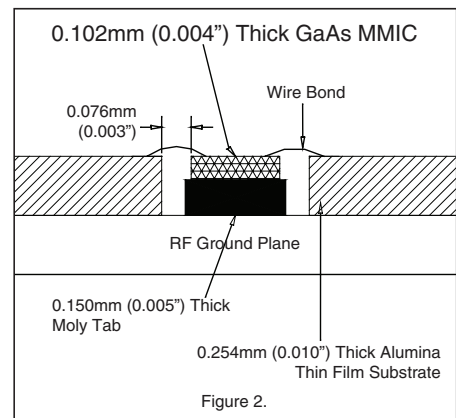

General Handling: Handle the chip along the edges with a vacuum collet or with a sharp pair of bent tweezers. The surface of the chip has fragile air bridges and should not be touched with vacuum collet, tweezers, or fingers.

Mounting

The chip is back-metallized and can be die mounted with AuSn eutectic preforms or with electrically conductive epoxy. The mounting surface should be clean and flat.

Eutectic Die Attach: A 80/20 gold tin preform is recommended with a work surface temperature of 255 deg. C and a tool temperature of 265 deg. C. When hot 90/10 nitrogen/hydrogen gas is applied, tool tip temperature should be 290 deg. C. DO NOT expose the chip to a temperature greater than 320 deg. C for more than 20 seconds. No more than 3 seconds of scrubbing should be required for attachment.

Epoxy Die Attach: Apply a minimum amount of epoxy to the mounting surface so that a thin epoxy fillet is observed around the perimeter of the chip once it is placed into position. Cure epoxy per the manufacturer's schedule.

Wire Bonding

Ball or wedge bond with 0.025mm (1 mil) diameter pure gold wire. Thermosonic wirebonding with a nominal stage temperature of 150 deg. C and a ball bonding force of 40 to 50 grams or wedge bonding force of 18 to 22 grams is recommended. Use the minimum level of ultrasonic energy to achieve reliable wirebonds. Wirebonds should be started on the chip and terminated on the package or substrate. All bonds should be as short as possible <0.31mm (12 mils).