

## 512-MBIT (32M × 8 BITS) CMOS NAND E<sup>2</sup>PROM (32M BYTE SmartMedia™)

### DESCRIPTION

The TH58512 is a single 3.3-V 512-Mbit (553,648,128) bit NAND Electrically Erasable and Programmable Read-Only Memory (NAND E<sup>2</sup>PROM) organized as 528 bytes × 32 pages × 4096 blocks. The device has a 528-byte static register which allows program and read data to be transferred between the register and the memory cell array in 528-byte increments. The Erase operation is implemented in a single block unit (16 Kbytes + 512 bytes: 528 bytes × 32 pages).

The TH58512 is a serial-type memory device which utilizes the I/O pins for both address and data input/output as well as for command inputs. The Erase and Program operations are automatically executed making the device most suitable for applications such as solid-state file storage, voice recording, image file memory for still cameras and other systems which require high-density non-volatile memory data storage.

The data stored in the TH58512DC needs to comply with the data format standardized by the SSFDC Forum in order to maintain compatibility with other SmartMedia™ systems.

### FEATURES

- Organization
  - Memory cell array 528 × 64K × 8 × 2
  - Register 528 × 8
  - Page size 528 bytes
  - Block size (16K + 512) bytes
- Modes
  - Read, Reset, Auto Page Program
  - Auto Block Erase, Status Read
- Mode control
  - Serial input/output
  - Command control
- Complies with the SmartMedia™ Electrical Specification and Data Format Specification issued by the SSFDC Forum
- Power supply
  - V<sub>CC</sub> = 3.3 V ± 0.3 V
- Access time
  - Cell array-register 25 μs max
  - Serial Read cycle 80 ns min
- Operating current
  - Read (50-ns cycle) 10 mA typ.
  - Program (avg.) 10 mA typ.
  - Erase (avg.) 10 mA typ.
  - Standby 100 μA max
- Packages
  - TC58512DC:FDC - 22C
  - (Weight: 2.2 g typ.)

### PIN ASSIGNMENT (TOP VIEW)

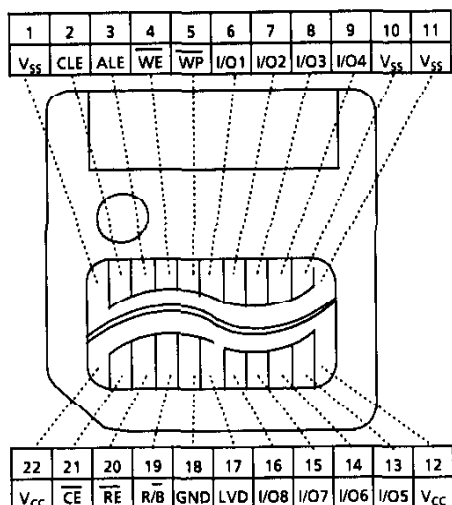

### PIN NAMES

I/O <sub>1</sub> to 8	I/O port
CE	Chip enable
WE	Write enable
RE	Read enable
CLE	Command latch enable
ALE	Address latch enable
WP	Write protect
R/B	Ready / Busy
GND	Ground Input
LVD	Low Voltage Detect
V <sub>CC</sub>	Power supply
V <sub>SS</sub>	Ground

SmartMedia™ is a trademark of Toshiba Corporation.

961001EBA1

- TOSHIBA is continually working to improve the quality and the reliability of its products. Nevertheless, semiconductor devices in general can malfunction or fail due to their inherent electrical sensitivity and vulnerability to physical stress. It is the responsibility of the buyer, when utilizing TOSHIBA products, to observe standards of safety, and to avoid situations in which a malfunction or failure of a TOSHIBA product could cause loss of human life, bodily injury or damage to property. In developing your designs, please ensure that TOSHIBA products are used within specified operating ranges as set forth in the most recent products specifications. Also, please keep in mind the precautions and conditions set forth in the TOSHIBA Semiconductor Reliability Handbook.
- The products described in this document are subject to foreign exchange and foreign trade control laws.
- The information contained herein is presented only as a guide for the applications of our products. No responsibility is assumed by TOSHIBA CORPORATION for any infringements of intellectual property or other rights of the third parties which may result from its use. No license is granted by implication or otherwise under any intellectual property or other rights of TOSHIBA CORPORATION or others.
- The information contained herein is subject to change without notice.

**BLOCK DIAGRAM**

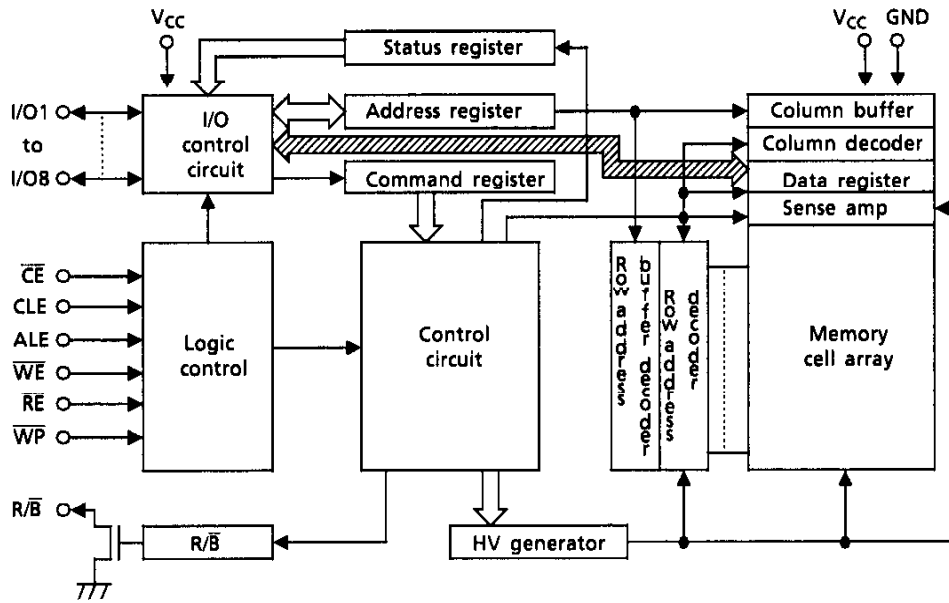

**ABSOLUTE MAXIMUM RATINGS**

SYMBOL	RATING	VALUE	UNIT
V <sub>CC</sub>	Power Supply Voltage	-0.6 to 4.6	V
V <sub>IN</sub>	Input Voltage	-0.6 to 4.6	V
V <sub>I/O</sub>	Input / Output Voltage	-0.6 V ~ V <sub>CC</sub> + 0.3 V (≦4.6 V)	V
P <sub>D</sub>	Power Dissipation	0.3	W
T <sub>STG</sub>	Storage Temperature	-20 to 65	°C
T <sub>OPR</sub>	Operating Temperature	0 to 55	°C

**CAPACITANCE** \*(T<sub>a</sub> = 25°C, f = 1 MHz)

SYMBOL	PARAMETER	CONDITION	MIN	MAX	UNIT
C <sub>IN</sub>	Input	V <sub>IN</sub> = 0 V	—	50	pF
C <sub>OUT</sub>	Output	V <sub>OUT</sub> = 0 V	—	50	pF

\* This parameter is periodically sampled and is not tested for every device.

## VALID BLOCKS (1)

SYMBOL	PARAMETER	MIN	TYP.	MAX	UNIT
$N_{VB}$	Number of Valid Blocks	4016	—	4096	Blocks

(1) The TH58512 occasionally contains unusable blocks. Refer to Application Note (13) toward the end of this document.

## RECOMMENDED DC OPERATING CONDITIONS

SYMBOL	PARAMETER	MIN	TYP.	MAX	UNIT
$V_{CC}$	Power Supply Voltage	3.0	3.3	3.6	V
$V_{IH}$	High Level Input Voltage	2.0	—	$V_{CC} + 0.3$	V
$V_{IL}$	Low Level Input Voltage	-0.3*	—	0.8	V

\* -2 V (pulse width  $\leq 20$  ns)

## DC CHARACTERISTICS

( $T_a = 0^\circ$  to  $55^\circ\text{C}$ ,  $V_{CC} = 3.3\text{ V} \pm 0.3\text{ V}$ )

SYMBOL	PARAMETER	CONDITION	MIN	TYP.	MAX	UNIT
$I_{IL}$	Input Leakage Current	$V_{IN} = 0\text{ V to } V_{CC}$	—	—	$\pm 10$	$\mu\text{A}$
$I_{LO}$	Output Leakage Current	$V_{OUT} = 0.4\text{ V to } V_{CC}$	—	—	$\pm 10$	$\mu\text{A}$
$I_{CC01}$	Operating Current (Serial Read)	$\overline{CE} = V_{IL}$ , $I_{OUT} = 0\text{ mA}$ , $t_{cycle} = 80\text{ ns}$	—	10	30	mA
$I_{CC03}$	Operating Current (Command Input)	$t_{cycle} = 80\text{ ns}$	—	10	30	mA
$I_{CC04}$	Operating Current (Data Input)	$t_{cycle} = 80\text{ ns}$	—	10	30	mA
$I_{CC05}$	Operating Current (Address Input)	$t_{cycle} = 80\text{ ns}$	—	10	30	mA
$I_{CC07}$	Programming Current	—	—	10	30	mA
$I_{CC08}$	Erasing Current	—	—	10	30	mA
$I_{CCS1}$	Standby Current	$\overline{CE} = V_{IH}$	—	—	1	mA
$I_{CCS2}$	Standby Current	$\overline{CE} = V_{CC} - 0.2\text{ V}$	—	—	100	$\mu\text{A}$
$V_{OH}$	High Level Output Voltage	$I_{OH} = -400\text{ }\mu\text{A}$	2.4	—	—	V
$V_{OL}$	Low Level Output Voltage	$I_{OL} = 2.1\text{ mA}$	—	—	0.4	V
$I_{OL}(R/\overline{B})$	Output Current of $R/\overline{B}$ Pin	$V_{OL} = 0.4\text{ V}$	—	8	—	mA

## AC CHARACTERISTICS AND RECOMMENDED OPERATING CONDITIONS

(Ta = 0° to 55 °C, V<sub>CC</sub> = 3.3 V ± 0.3 V)

SYMBOL	PARAMETER	MIN	MAX	UNIT	NOTES
t <sub>CLS</sub>	CLE Setup Time	20	—	ns	
t <sub>CLH</sub>	CLE Hold Time	40	—	ns	
t <sub>CS</sub>	$\overline{CE}$ Setup Time	20	—	ns	
t <sub>CH</sub>	$\overline{CE}$ Hold Time	40	—	ns	
t <sub>WP</sub>	Write Pulse Width	40	—	ns	
t <sub>ALS</sub>	ALE Setup Time	20	—	ns	
t <sub>ALH</sub>	ALE Hold Time	40	—	ns	
t <sub>DS</sub>	Data Setup Time	30	—	ns	
t <sub>DH</sub>	Data Hold Time	20	—	ns	
t <sub>WC</sub>	Write Cycle Time	80	—	ns	
t <sub>WH</sub>	$\overline{WE}$ -High Hold Time	20	—	ns	
t <sub>WW</sub>	$\overline{WP}$ High to $\overline{WE}$ Low	100	—	ns	
t <sub>RR</sub>	Ready-to- $\overline{RE}$ Falling Edge	20	—	ns	
t <sub>RP</sub>	Read Pulse Width	60	—	ns	
t <sub>RC</sub>	Read Cycle Time	80	—	ns	
t <sub>REA</sub>	$\overline{RE}$ Access Time (Serial Data Access)	—	45	ns	
t <sub>CFH</sub>	$\overline{CE}$ -High Time for Last Address in Serial Read Cycle	100	—	ns	(2)
t <sub>REAID</sub>	$\overline{RE}$ Access Time (ID Read)	—	45	ns	
t <sub>OH</sub>	Data Output Hold Time	10	—	ns	
t <sub>RIH</sub>	$\overline{RE}$ -High-to-Output-High Impedance	—	30	ns	
t <sub>CHZ</sub>	$\overline{CE}$ -High-to-Output-High Impedance	—	20	ns	
t <sub>REH</sub>	$\overline{RE}$ -High Hold Time	20	—	ns	
t <sub>IR</sub>	Output-High-Impedance-to- $\overline{RE}$ Rising Edge	0	—	ns	
t <sub>RSTO</sub>	$\overline{RE}$ Access Time (Status Read)	—	45	ns	
t <sub>CSTO</sub>	$\overline{CE}$ Access Time (Status Read)	—	55	ns	
t <sub>RHW</sub>	$\overline{RE}$ High to $\overline{WE}$ Low	0	—	ns	
t <sub>WHC</sub>	$\overline{WE}$ High to $\overline{CE}$ Low	50	—	ns	
t <sub>WHR</sub>	$\overline{WE}$ High to $\overline{RE}$ Low	50	—	ns	
t <sub>AR1</sub>	ALE Low to $\overline{RE}$ Low (ID Read)	100	—	ns	
t <sub>CR</sub>	$\overline{CE}$ Low to $\overline{RE}$ Low (ID Read)	100	—	ns	
t <sub>R</sub>	Memory Cell Array to Starting Address	—	25	μs	
t <sub>WB</sub>	$\overline{WE}$ High to Busy	—	200	ns	
t <sub>AR2</sub>	ALE Low to $\overline{RE}$ Low (Read Cycle)	50	—	ns	
t <sub>RB</sub>	$\overline{RE}$ Last Clock Rising Edge to Busy (in Sequential Read)	—	200	ns	
t <sub>CRY</sub>	$\overline{CE}$ High to Ready (When interrupted by $\overline{CE}$ in Read Mode)	—	600 + t <sub>r</sub> (R/ $\overline{B}$ )	ns	(1)
t <sub>RST</sub>	Device Reset Time (Read/Program/Erase)	—	6/10/500	μs	

## AC TEST CONDITIONS

Input level : 2.4 V / 0.4 V  
 Input pulse rise and fall time : 3ns  
 Input comparison level : 1.5 V / 1.5 V  
 Output data comparison level : 1.5 V / 1.5 V  
 Output load : 1 TTL + C<sub>L</sub> (100 pF)

Note : (1)  $\overline{CE}$  High to Ready time depends on the pull-up resistor tied to the  $R/\overline{B}$  pin.  
(Refer to Application Note (7) toward the end of this document.)

(2) Sequential Read is terminated when  $t_{CEH}$  is greater than or equal to 100 ns.  
If the  $\overline{RE}$  to  $\overline{CE}$  delay is less than 30ns,  $R/\overline{B}$  signal stays Ready.

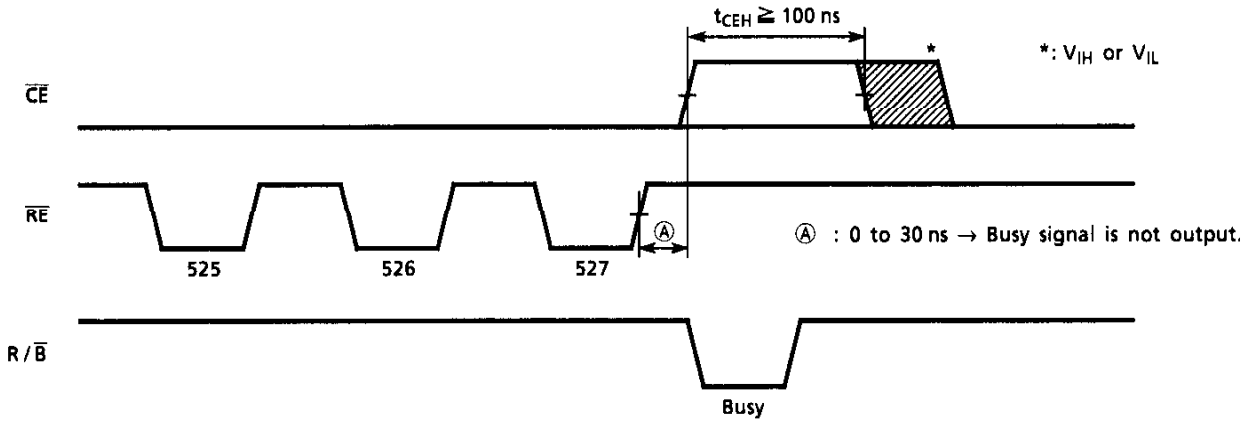

**PROGRAMMING AND ERASING CHARACTERISTICS**

( $T_a = 0^\circ \text{ to } 55^\circ \text{C}$ ,  $V_{CC} = 3.3 \text{ V} \pm 0.3 \text{ V}$ )

SYMBOL	PARAMETER	MIN	TYP.	MAX	UNIT	NOTES
$t_{PROG}$	Average Programming Time		200	1000	$\mu\text{s}$	
N	Number of Programming Cycles on Same Page			10		(1)
$t_{BERASE}$	Block Erasing Time		3	4	ms	
P/E	Number of Program/Erase Cycles			1E5		(2)

(1) Refer to Application Note (12) toward the end of this document.

(2) Refer to Application Note (15) toward the end of this document.

**TIMING DIAGRAMS**

Latch Timing Diagram for Command/Address/Data

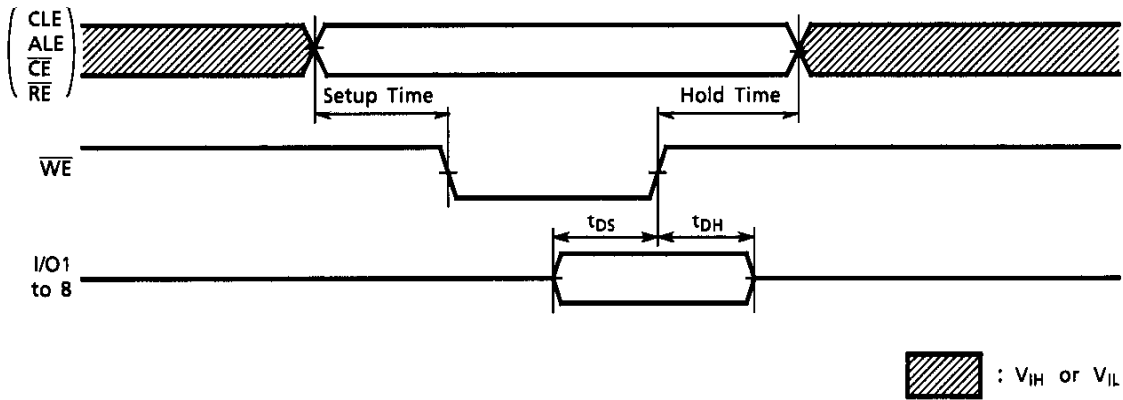

Command Input Cycle Timing Diagram

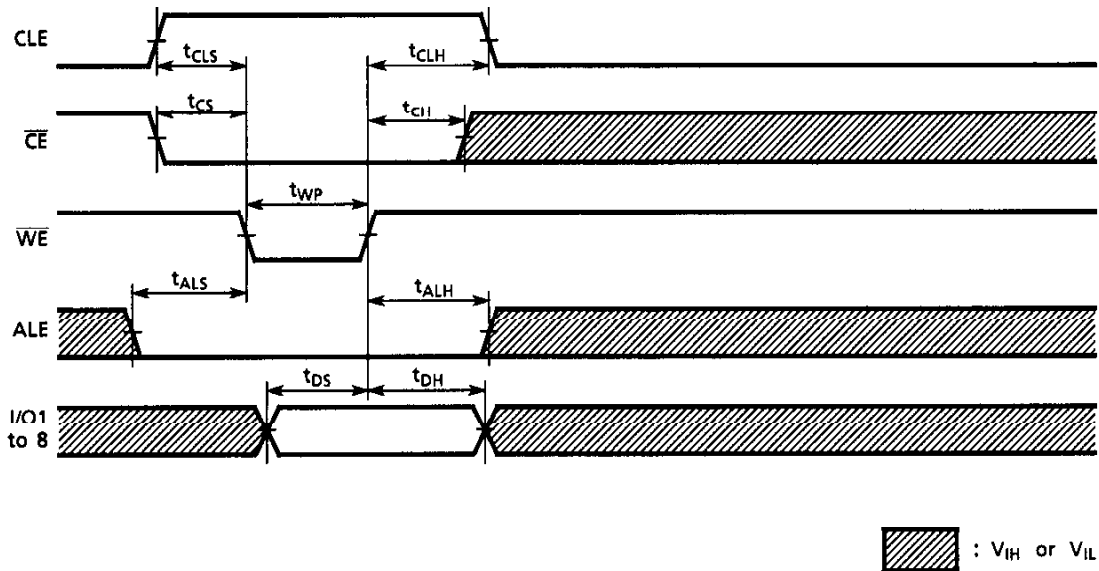

Address Input Cycle Timing Diagram

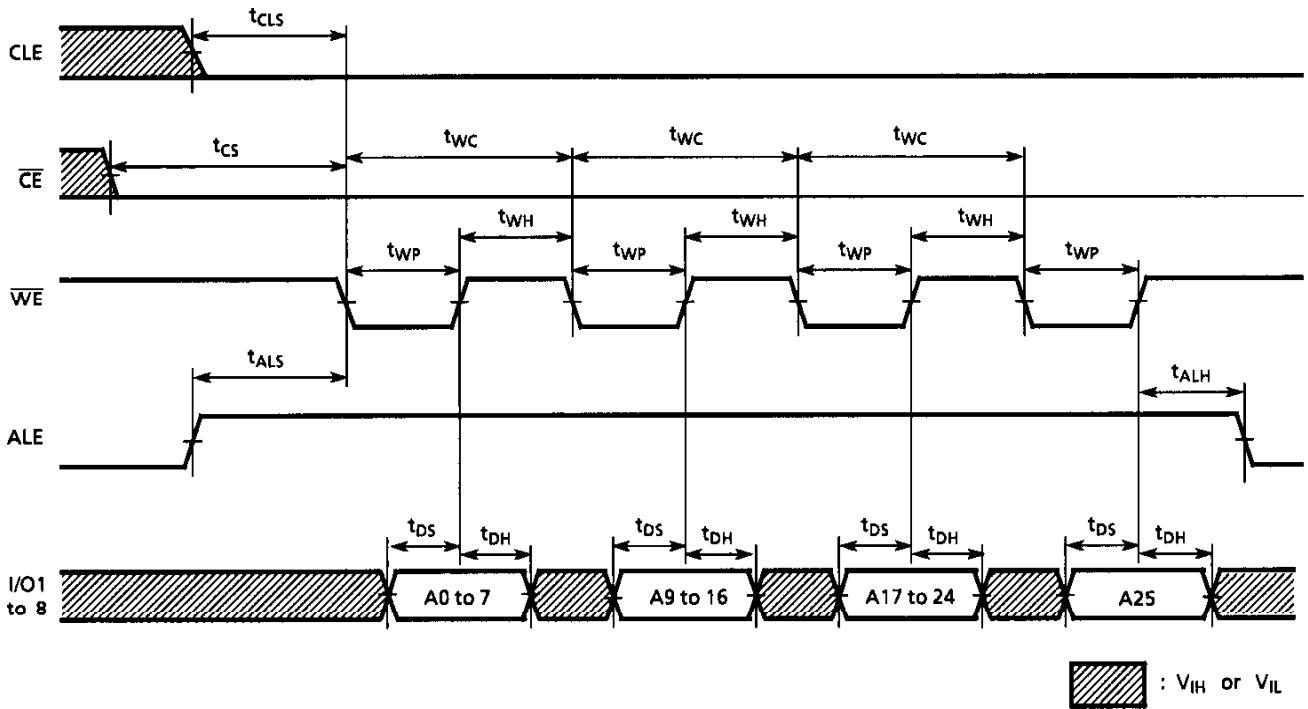

Data Input Cycle Timing Diagram

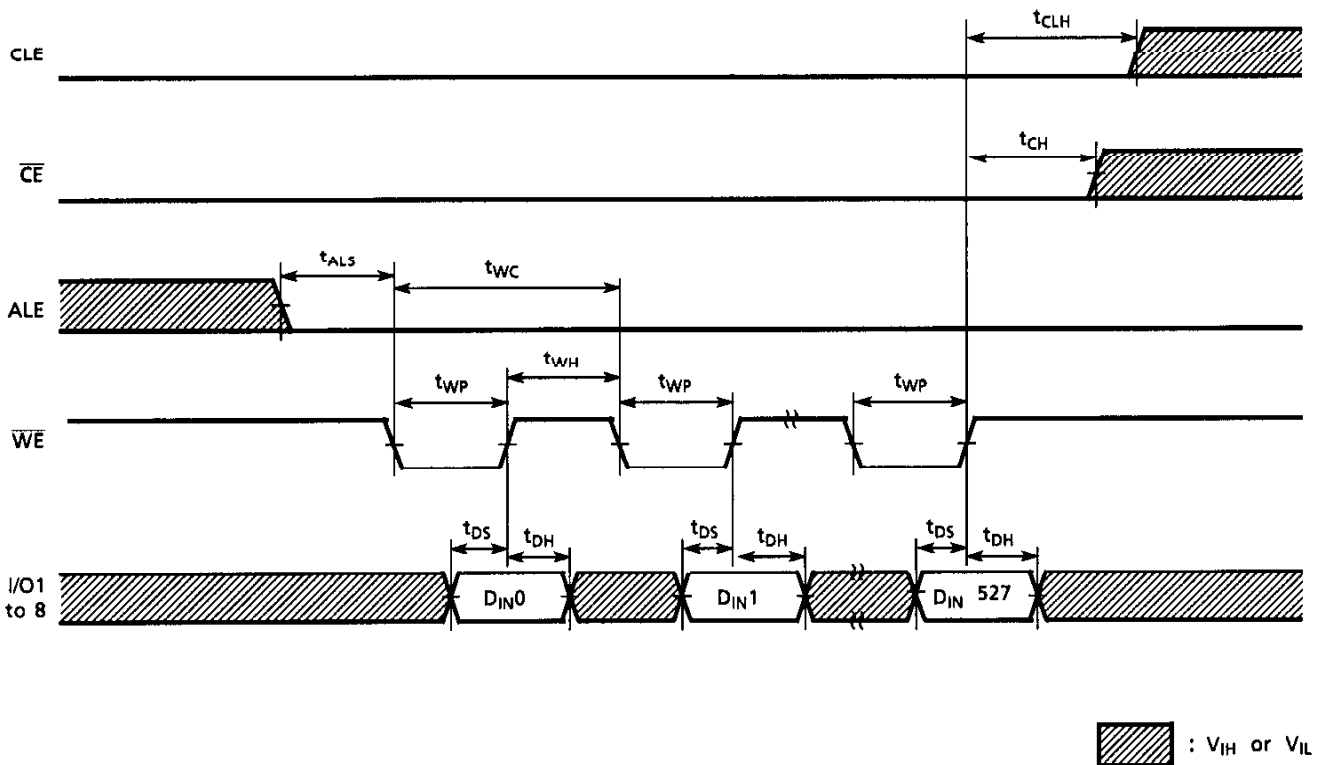

Serial Read Cycle Timing Diagram

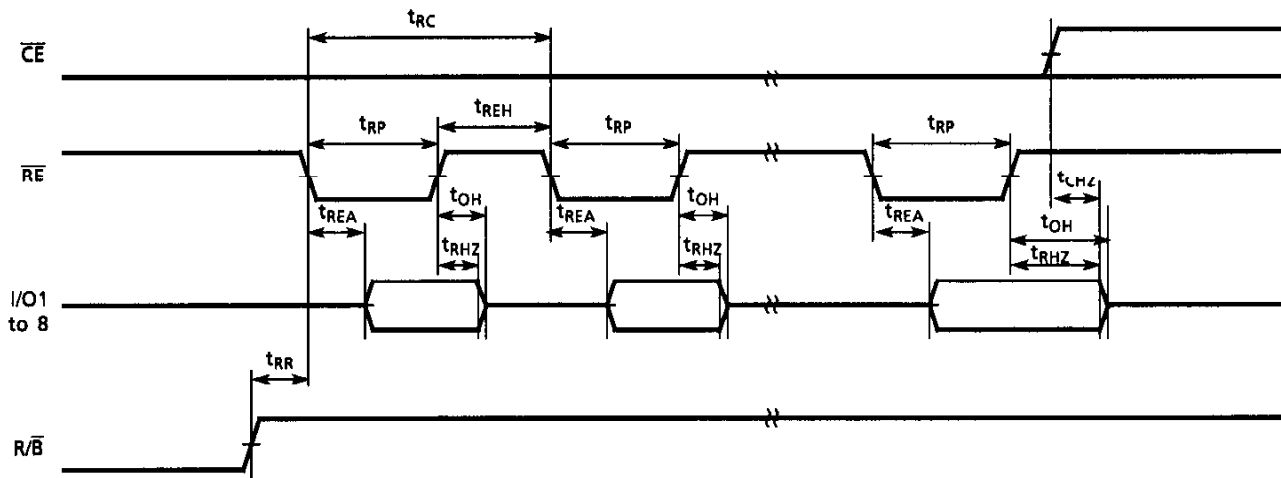

Status Read Cycle Timing Diagram

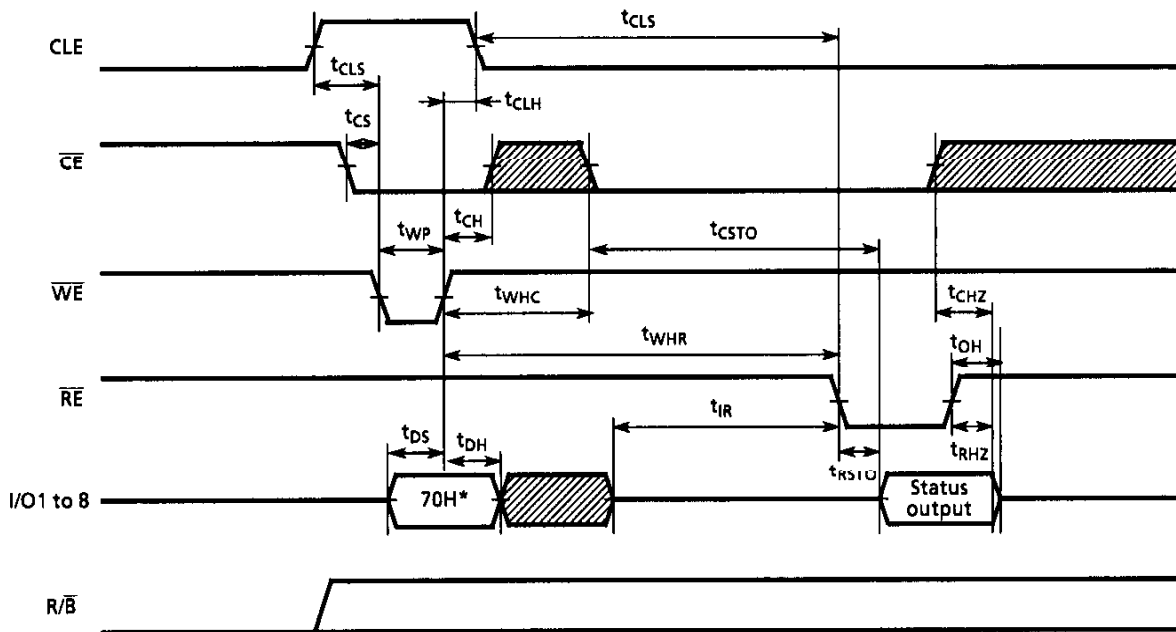

\* 70H represents the hexadecimal number 70.

 :  $V_{IH}$  or  $V_{IL}$



Read Cycle (1) Timing Diagram

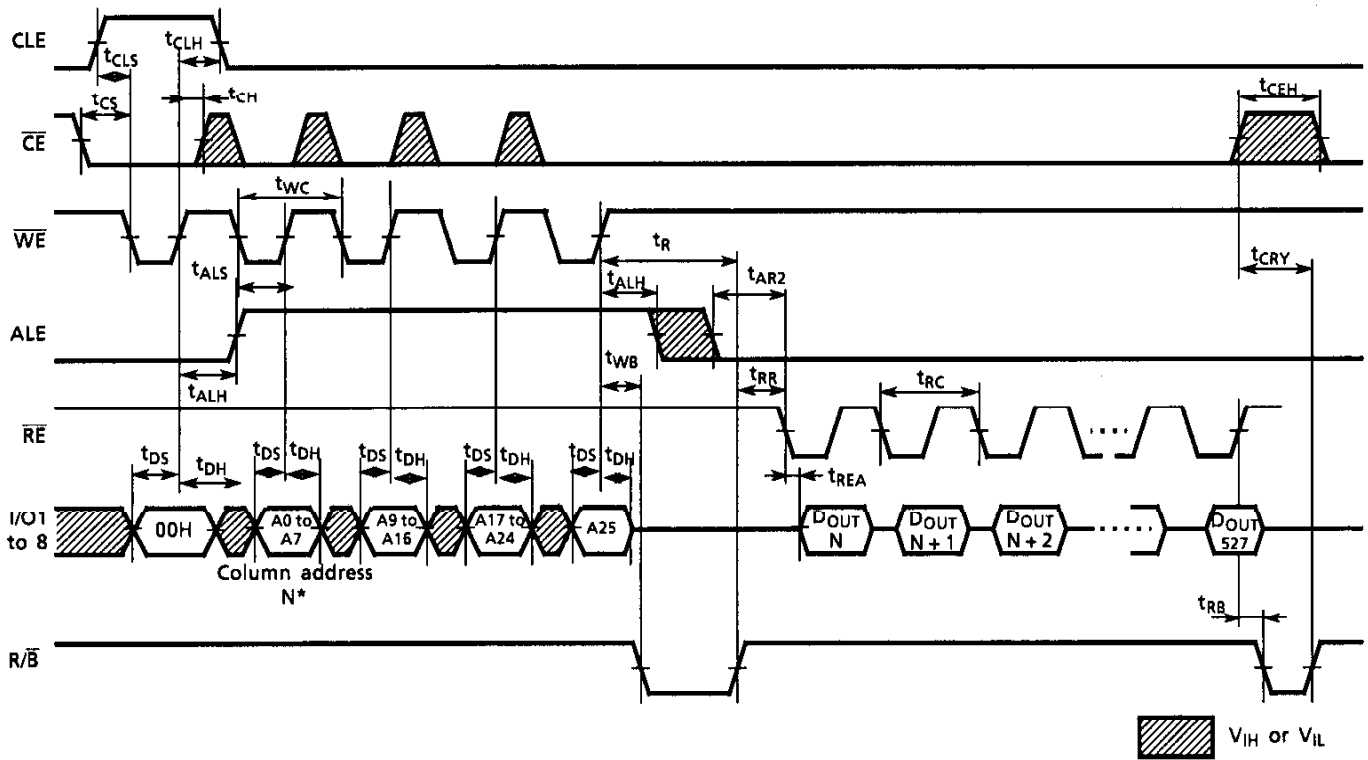

Read Cycle (1) Timing Diagram: When Interrupted by  $\overline{CE}$

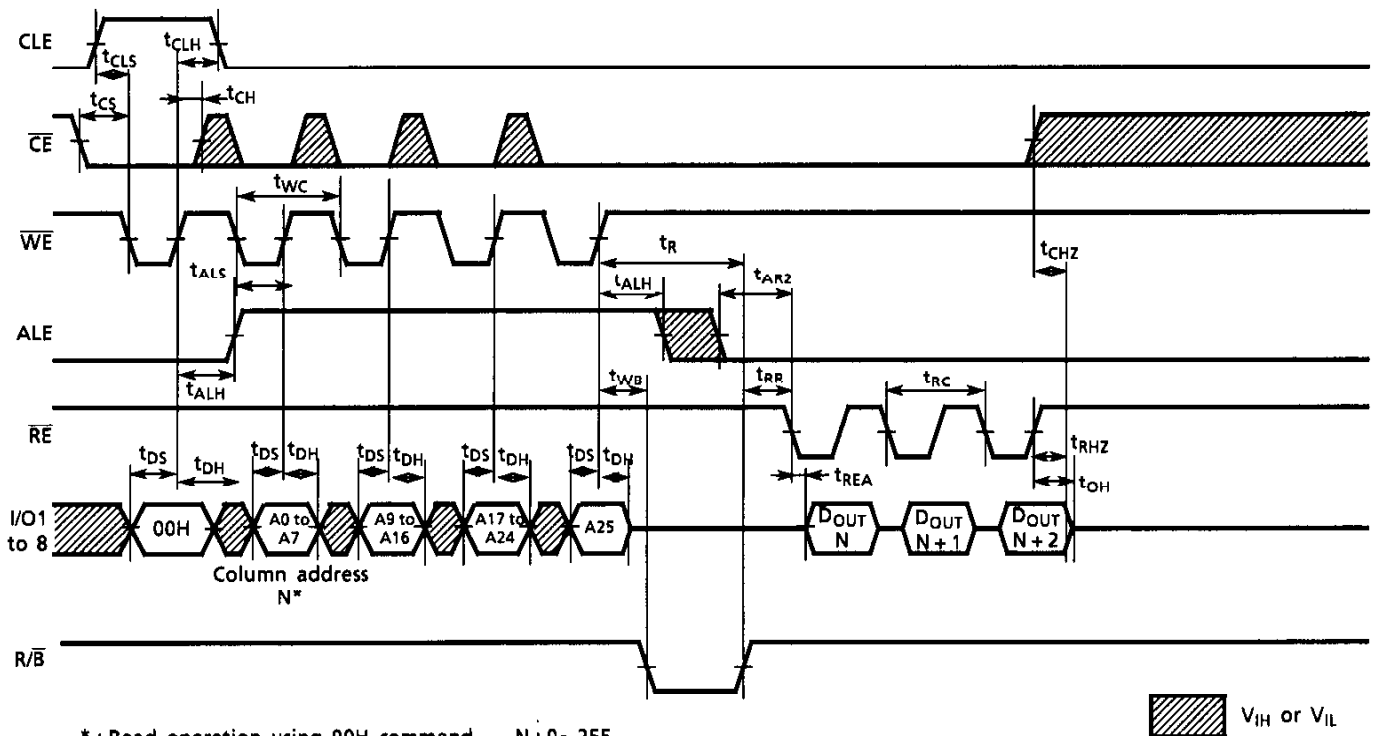

\* : Read operation using 00H command N : 0~255

Read Cycle (2) Timing Diagram

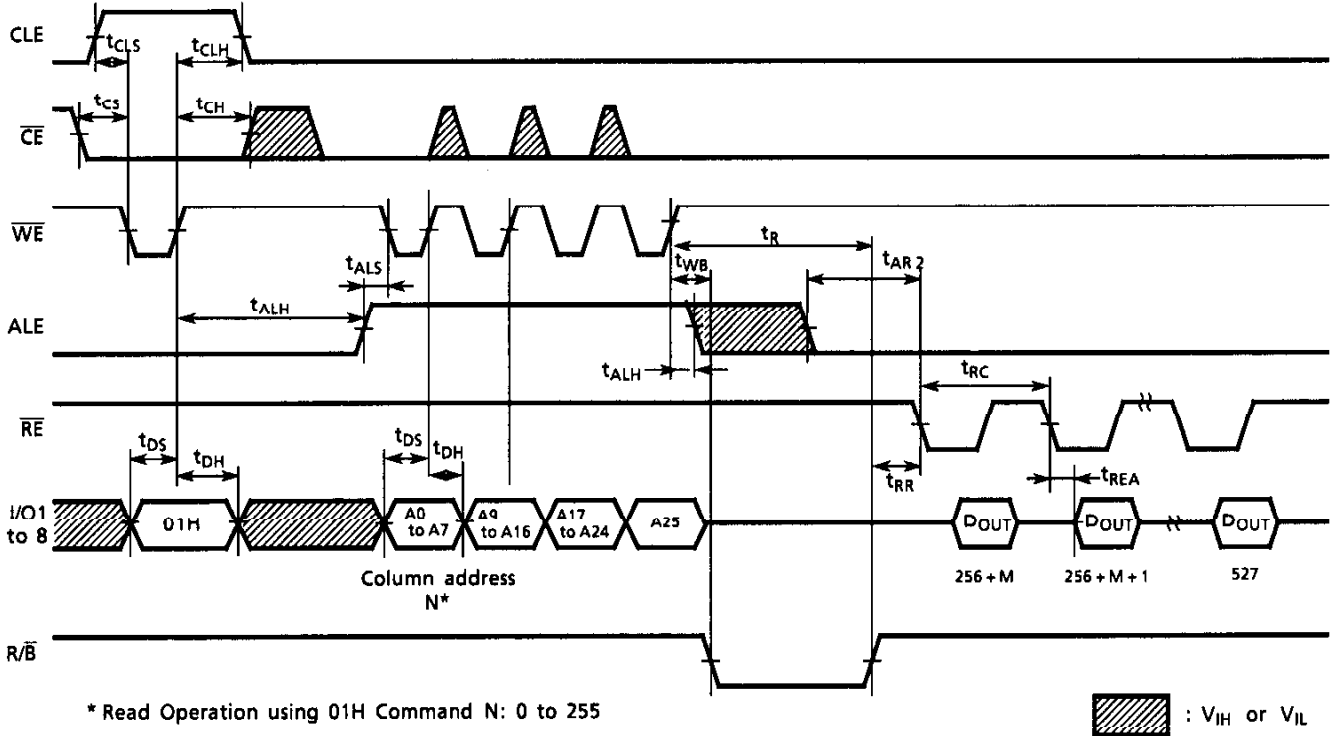

Read Cycle (3) Timing Diagram

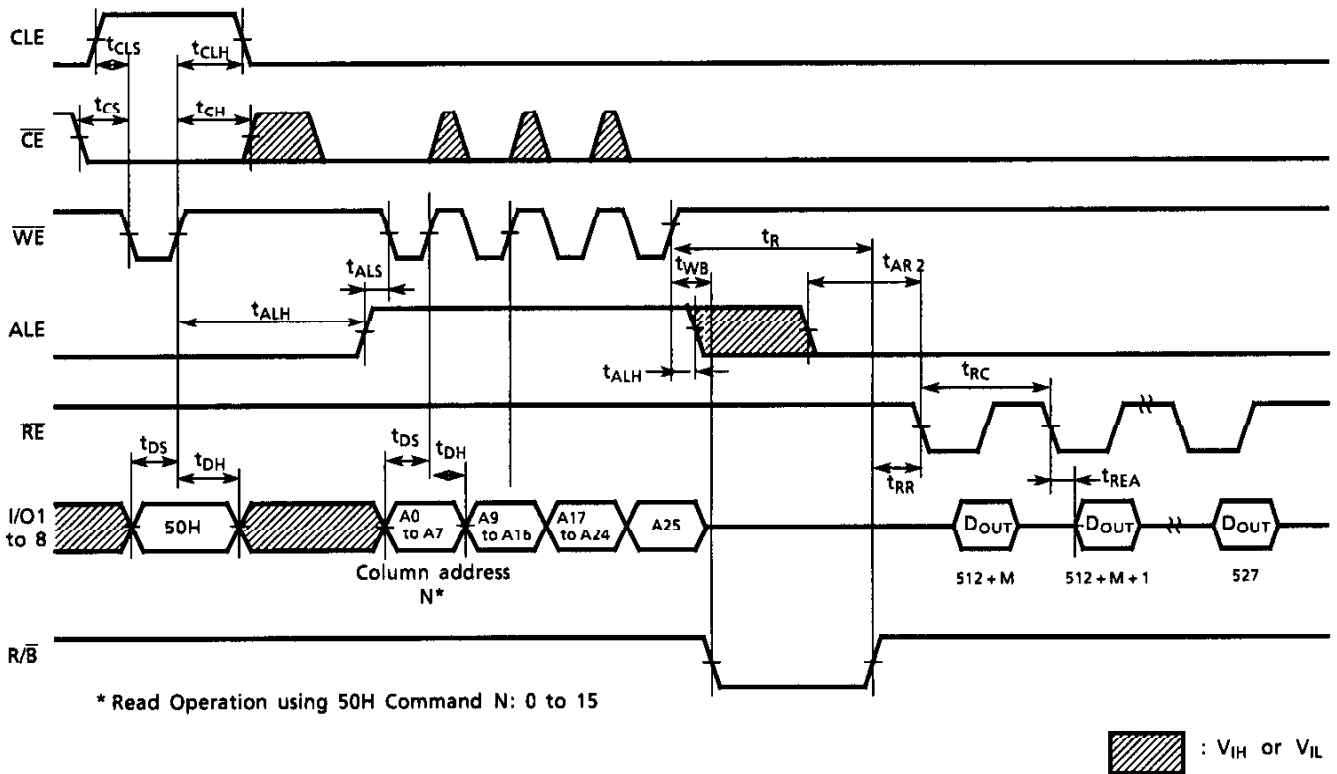

Sequential Read (1) Timing Diagram

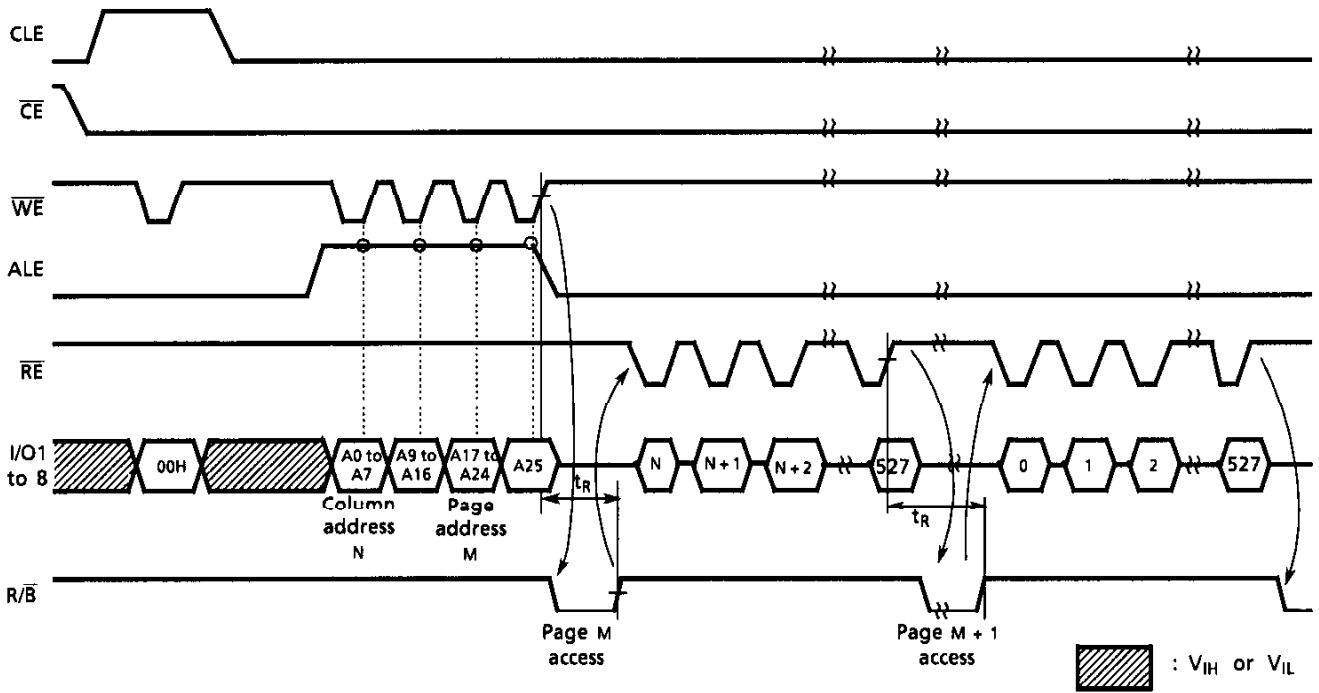

Sequential Read (2) Timing Diagram

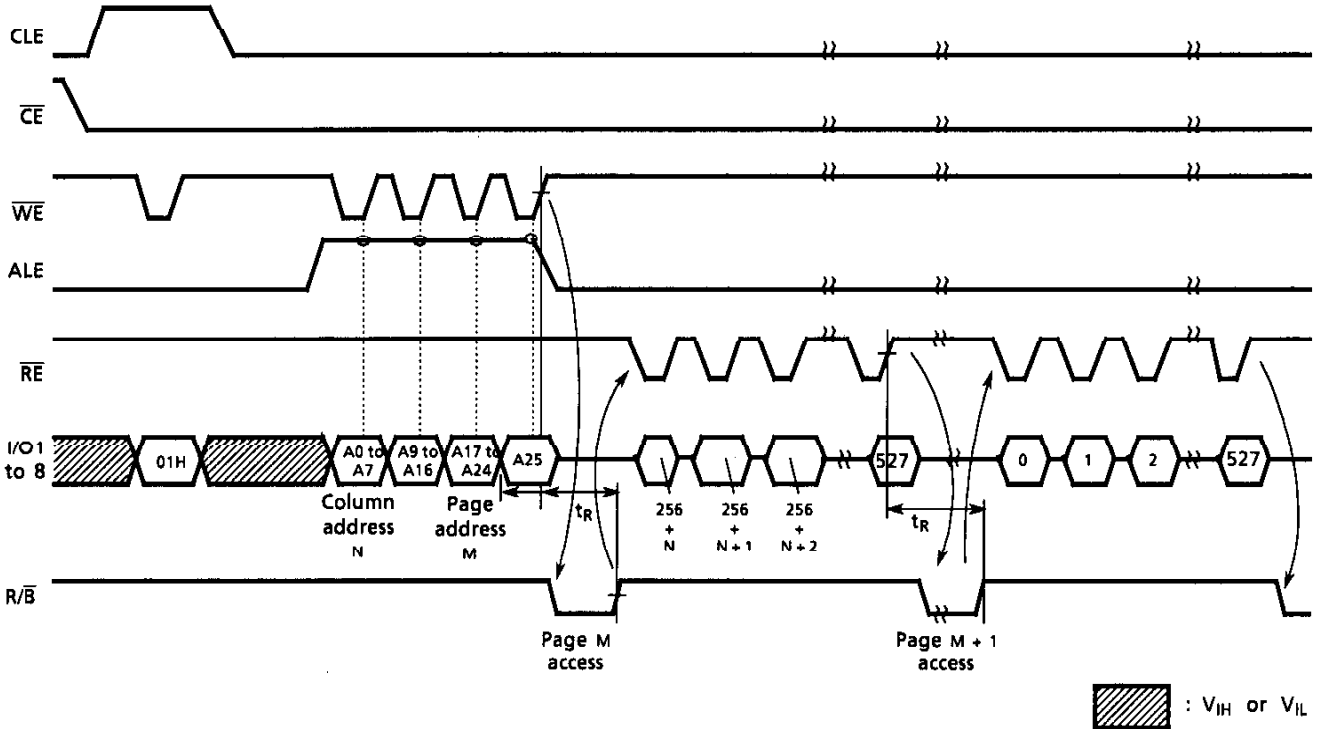

Sequential Read (3) Timing Diagram

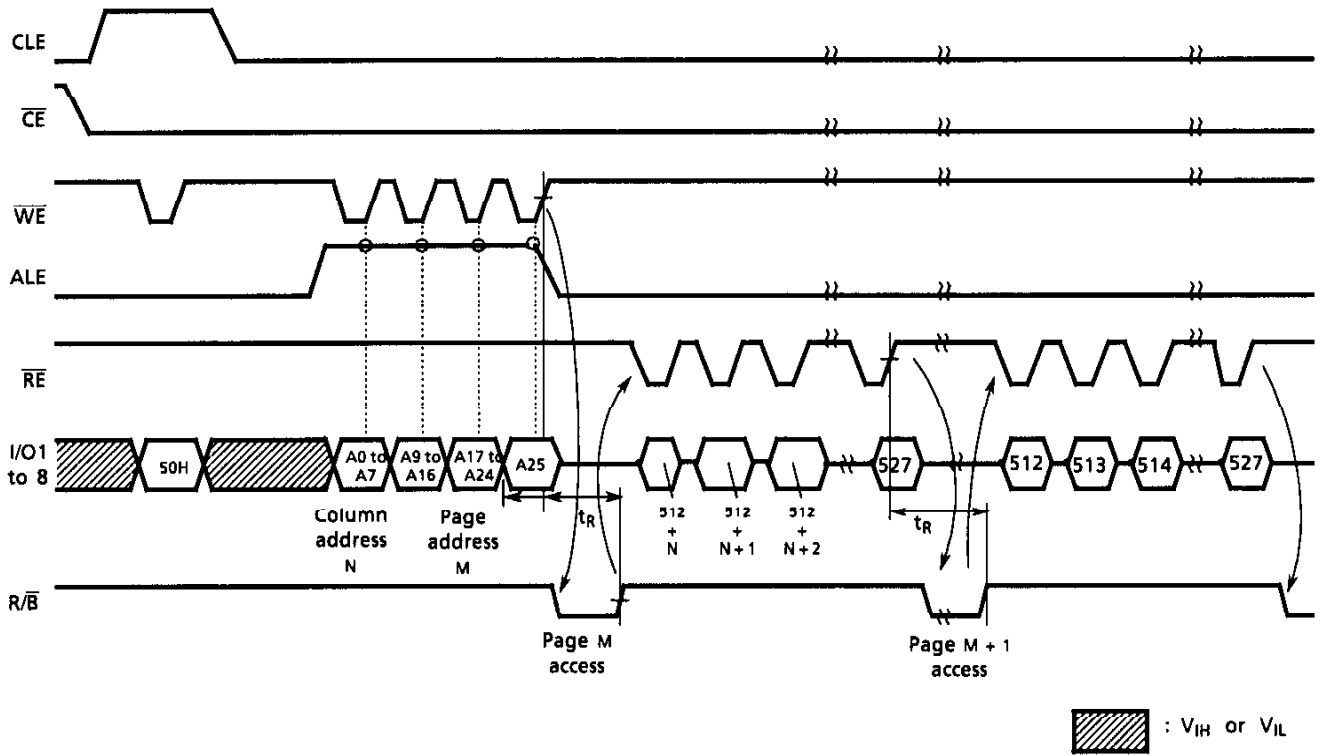

Auto-Program Operation Timing Diagram

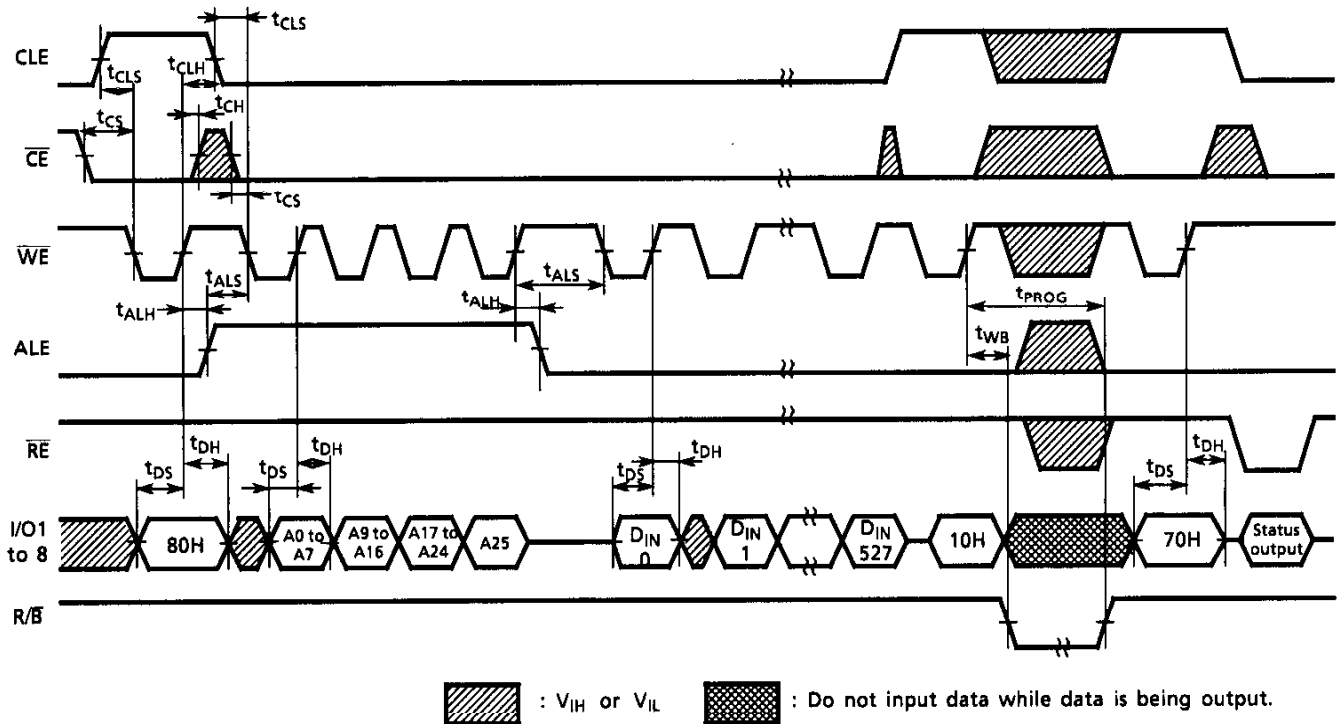

Auto Block Erase Timing Diagram

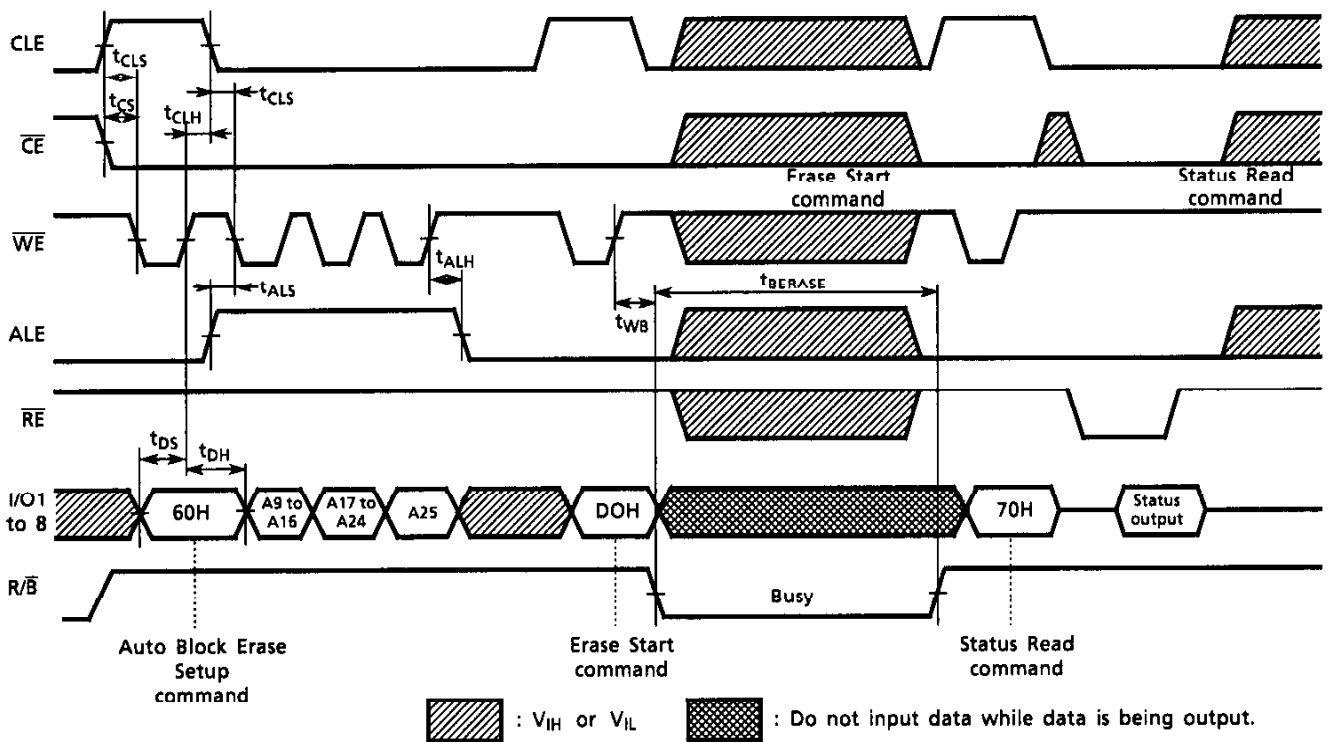

ID Read Operation Timing Diagram

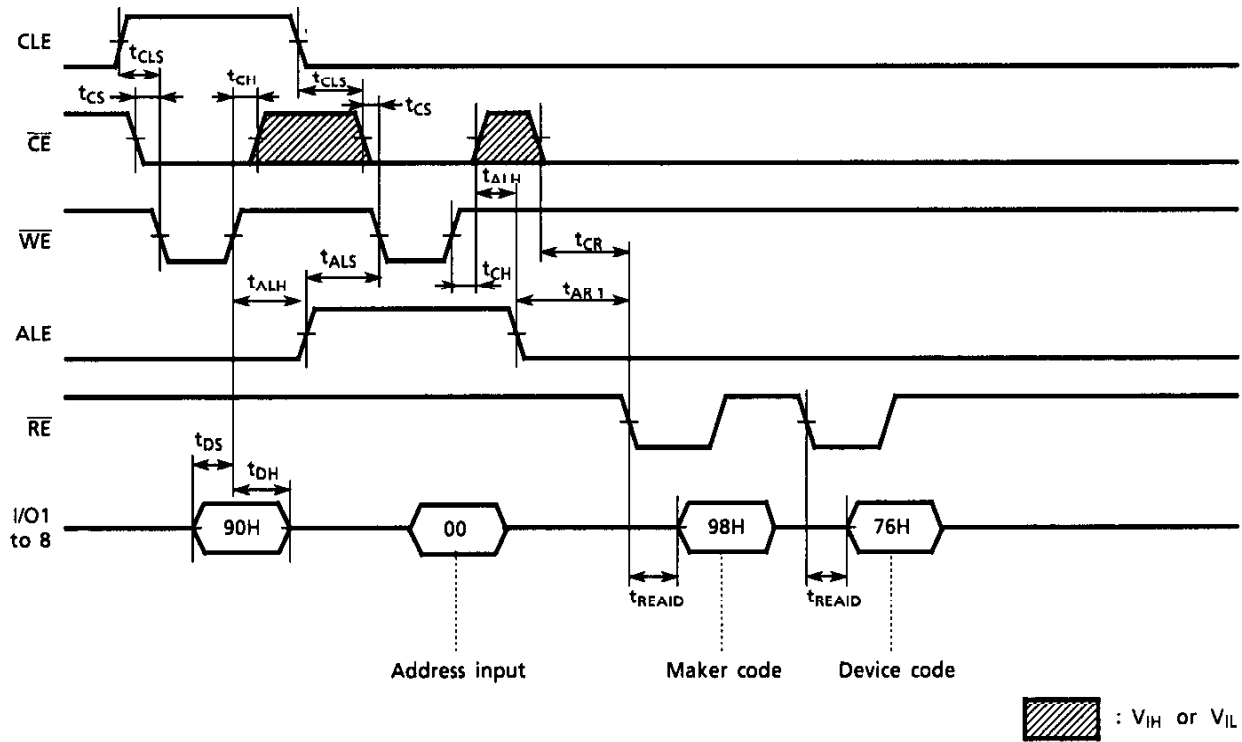

**PIN FUNCTIONS**

The device is a serial access memory which utilizes time-sharing input of address information. The device pin-outs are configured as shown in Figure 1.

**Command Latch Enable: CLE**

The CLE input signal is used to control loading of the operation mode command into the internal command register. The command is latched into the command register from the I/O port on the rising edge of the  $\overline{WE}$  signal while CLE is High.

**Address Latch Enable: ALE**

The ALE signal is used to control loading of either address information or input data into the internal address/data register. Address information is latched on the rising edge of  $\overline{WE}$  if ALE is High. Input data is latched if ALE is Low.

**Chip Enable:  $\overline{CE}$**

The device goes into a low-power Standby mode when  $\overline{CE}$  goes High during a Read operation. The  $\overline{CE}$  signal is ignored when device is in Busy state ( $R/\overline{B} = L$ ), such as during a Program or Erase operation, and will not enter Standby mode even if the  $\overline{CE}$  input goes High. The  $\overline{CE}$  signal must stay Low during the Read mode Busy state to ensure that memory array data is correctly transferred to the data register.

**Write Enable:  $\overline{WE}$**

The  $\overline{WE}$  signal is used to control the acquisition of data from the I/O port.

**Read Enable:  $\overline{RE}$**

The  $\overline{RE}$  signal controls serial data output. Data is available  $t_{REA}$  after the falling edge of  $\overline{RE}$ . The internal column address counter is also incremented (Address = Address + 1) on this falling edge.

**I/O Port: I/O1 to 8**

The I/O1 to 8 pins are used as a port for transferring address, command and input/output data to and from the device.

**Write Protect:  $\overline{WP}$**

The  $\overline{WP}$  signal is used to protect the device from accidental programming or erasing. The internal voltage regulator is reset when  $\overline{WP}$  is Low. This signal is usually used for protecting the data during the power-on/off sequence when input signals are invalid.

**Ready/Busy:  $R/\overline{B}$**

The  $R/\overline{B}$  output signal is used to indicate the operating condition of the device. The  $R/\overline{B}$  signal is in Busy state ( $R/\overline{B} = L$ ) during the Program, Erase and Read operations and will return to Ready state ( $R/\overline{B} = H$ ) after completion of the operation. The output buffer for this signal is an open drain.

**Low Voltage Detect: LVD**

The LVD signal is used to detect the power supply voltage level.

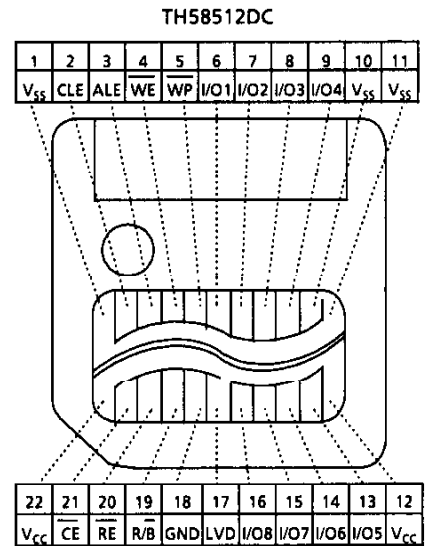
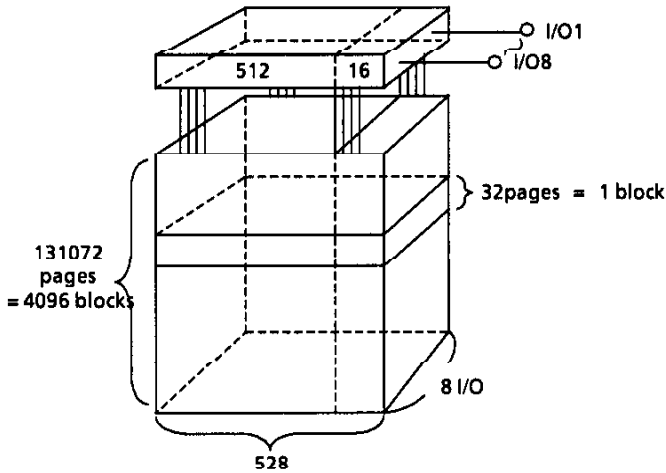

Figure 1. Pinout

**Schematic Cell Layout and Address Assignment**

The Program operation works on page units while the Erase operation works on block units.



A page consists of 528 bytes in which 512 bytes are used for main memory storage and 16 bytes are for redundancy or for other uses.

1 page = 528 bytes  
 1 block = 528 bytes × 32 pages = (16K + 512) bytes  
 Capacity = 528 bytes × 32 pages × 4096 blocks

An address is read in via the I/O port over four consecutive clock cycles, as shown in Table 1.

Figure 2. Schematic Cell Layout

Table 1. Addressing

	I/O8	I/O7	I/O6	I/O5	I/O4	I/O3	I/O2	I/O1
First cycle	A7	A6	A5	A4	A3	A2	A1	A0
Second cycle	A16	A15	A14	A13	A12	A11	A10	A9
Third cycle	A24	A23	A22	A21	A20	A19	A18	A17
Fourth cycle	*L	*L	*L	*L	*L	*L	*L	A25

A0 to A7: Column address  
 A9 to A25: Page address  
 (A14 to A25: Block address  
 (A9 to A13: NAND address in block))

\*: A8 is automatically set to Low or High by a 00H command or a 01H command.  
 \*: I/O2 to I/O8 must be set to Low in the fourth cycle.

**Operation Mode: Logic and Command Tables**

The operation modes such as Program, Erase, Read and Reset are controlled by the ten different command operations shown in Table 3. Address input, command input and data input/output are controlled by the CLE, ALE,  $\overline{CE}$ ,  $\overline{WE}$ ,  $\overline{RE}$  and  $\overline{WP}$  signals, as shown in Table 2.

Table 2. Logic Table

	CLE	ALE	$\overline{CE}$	$\overline{WE}$	$\overline{RE}$	$\overline{WP}$
Command Input	H	L	L		H	*
Data Input	L	L	L		H	*
Address Input	L	H	L		H	*
Serial Data Output	L	L	L	H		*
During Programming (Busy)	*	*	*	*	*	H
During Erasing (Busy)	*	*	*	*	*	H
Program, Erase Inhibit	*	*	*	*	*	L

H:  $V_{IH}$ , L:  $V_{IL}$ , \*:  $V_{IH}$  or  $V_{IL}$



Table 3. Command table (HEX)

	First Cycle	Second Cycle	Acceptable while Busy
Serial Data Input	80	—	
Read Mode (1)	00	—	
Read Mode (2)	01	—	
Read Mode (3)	50	—	
Reset	FF	—	○
Auto Program	10	—	
Auto Block Erase	60	D0	
Status Read	70	—	○
ID Read	90	—	

HEX data bit assignment  
(Example)

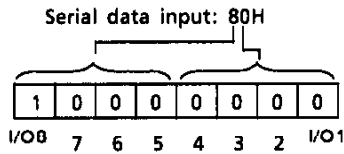

Once the device has been set to Read mode by a 00H, 01H or 50H command, additional Read commands are not needed for sequential page Read operations. Table 4 shows the operation states for Read mode.

Table 4. Read mode operation states

	CLE	ALE	$\overline{CE}$	$\overline{WE}$	$\overline{RE}$	I/O1 TO I/O8	Power
Output Select	L	L	L	H	L	Data output	Active
Output Deselect	L	L	L	H	H	High impedance	Active
Standby	L	L	H	H	*	High impedance	Standby

H:  $V_{IH}$  L:  $V_{IL}$  \*:  $V_{IH}$  or  $V_{IL}$

**DEVICE OPERATION**

**Read Mode (1)**

Read mode (1) is set when a "00H" command is issued to the Command register. Refer to Figure 3 below for timing details and the block diagram.

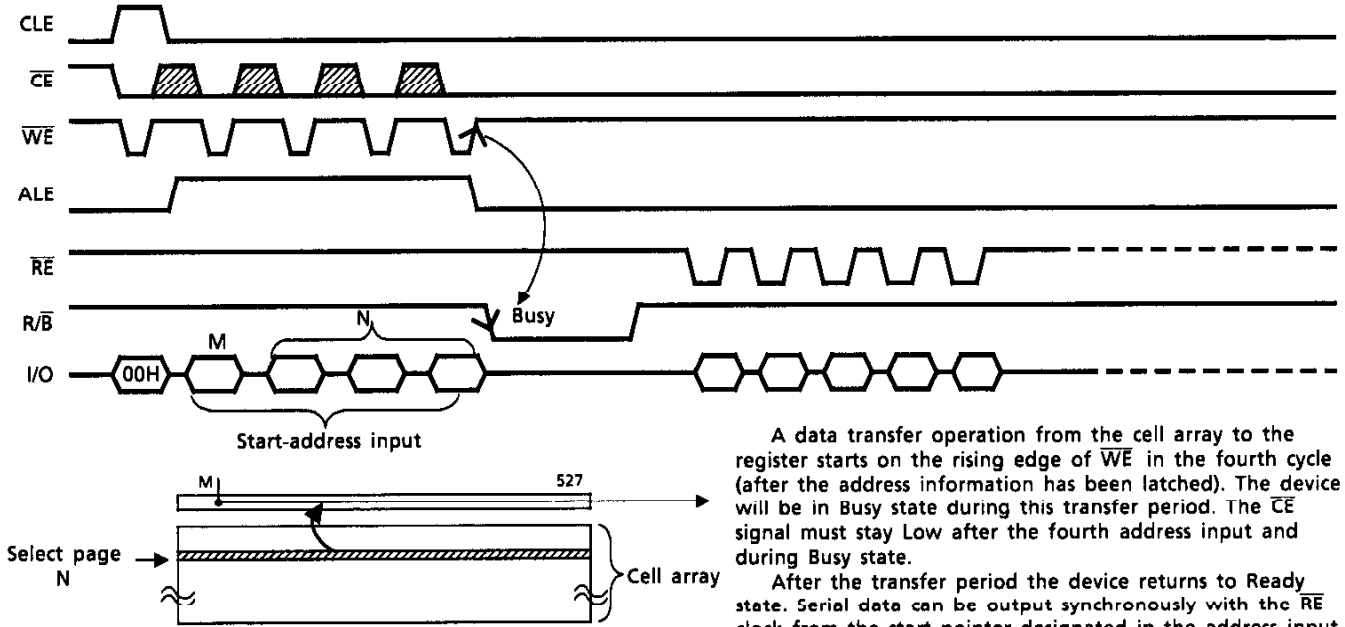

Figure 3. Read mode (1) operation

A data transfer operation from the cell array to the register starts on the rising edge of  $\overline{WE}$  in the fourth cycle (after the address information has been latched). The device will be in Busy state during this transfer period. The  $\overline{CE}$  signal must stay Low after the fourth address input and during Busy state.

After the transfer period the device returns to Ready state. Serial data can be output synchronously with the  $\overline{RE}$  clock from the start pointer designated in the address input cycle.

**Read Mode (2)**

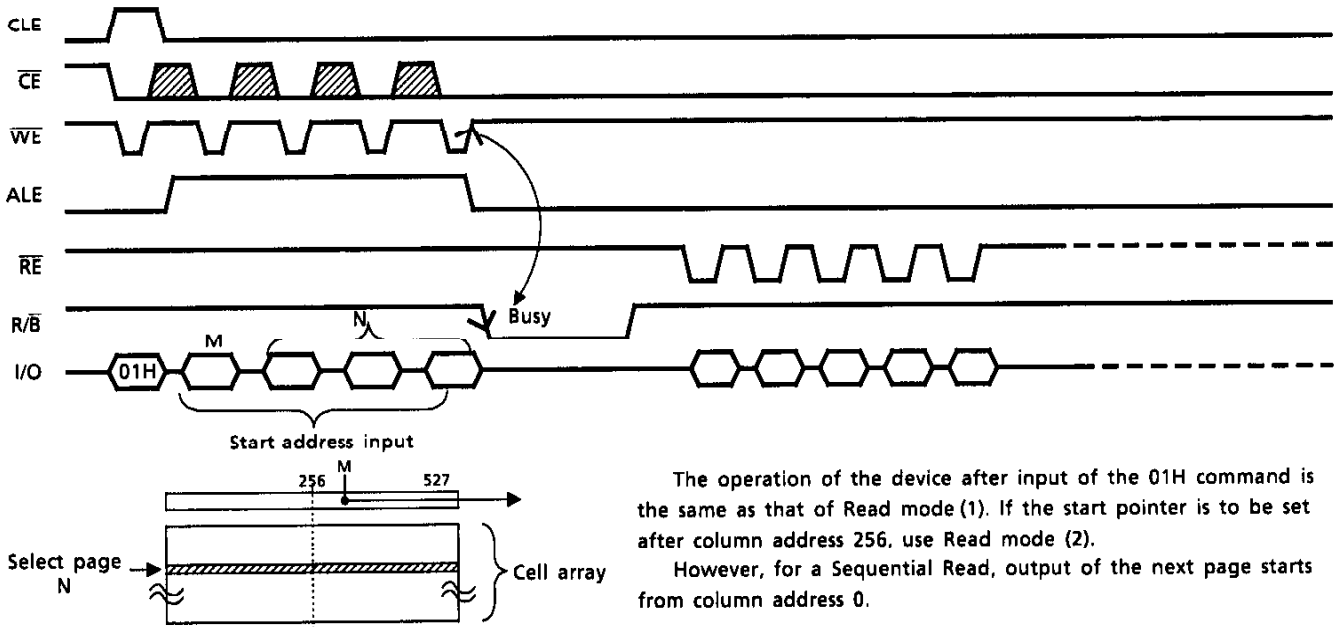

Figure 4. Read mode (2) operation

The operation of the device after input of the 01H command is the same as that of Read mode (1). If the start pointer is to be set after column address 256, use Read mode (2).

However, for a Sequential Read, output of the next page starts from column address 0.

**Read Mode (3)**

Read mode (3) has the same timing as Read modes (1) and (2) but is used to access information in the extra 16-byte redundancy area of the page. The start pointer is therefore set to a value between byte 512 and byte 527.

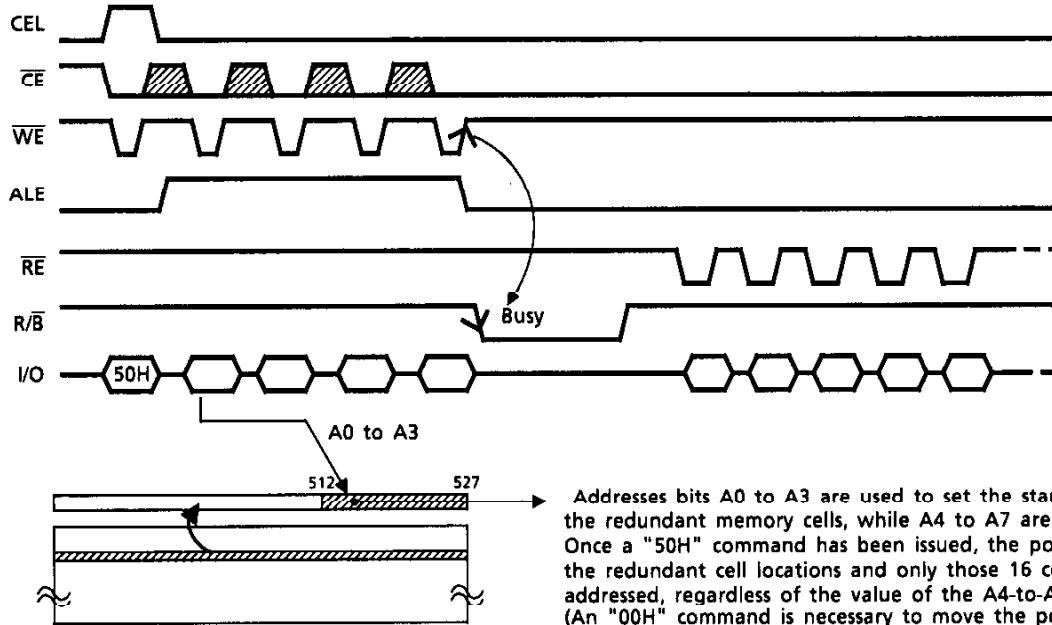
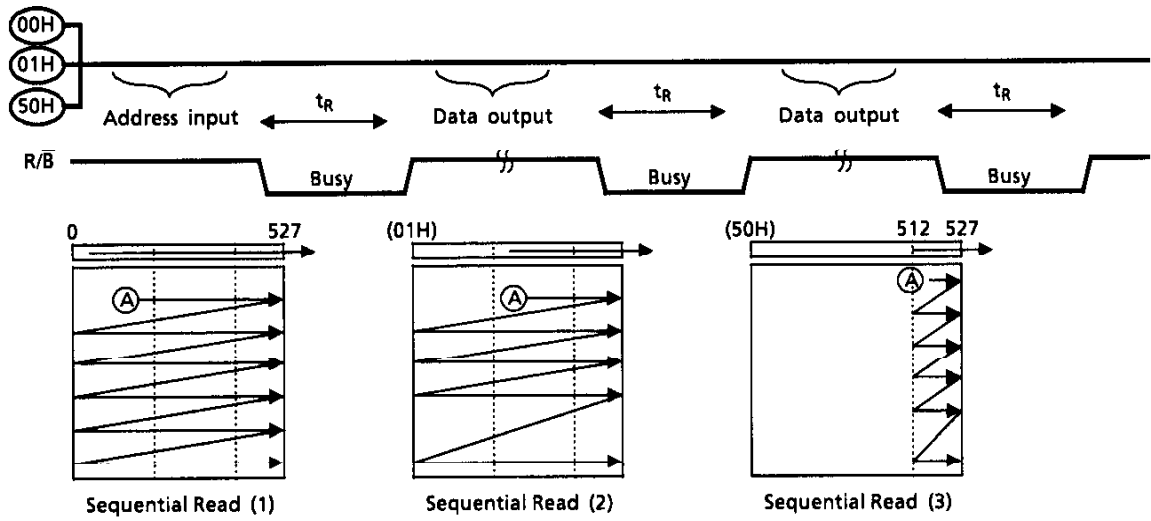

Figure 5. Read mode (3) operation

Addresses bits A0 to A3 are used to set the start pointer for the redundant memory cells, while A4 to A7 are ignored. Once a "50H" command has been issued, the pointer moves to the redundant cell locations and only those 16 cells can be addressed, regardless of the value of the A4-to-A7 address. (An "00H" command is necessary to move the pointer back to the 0-to-511 main memory cell location.)

Sequential Read (1)(2)(3)

This mode allows the sequential reading of pages without additional address input.



Sequential Read modes (1) and (2) output the contents of addresses 0 to 527 as shown above, while Sequential Read mode (3) outputs the contents of the redundant address locations only. When the page address reaches the next block address, read command(00H/01H/50H) and address input are needed.

**Status Read**

The device automatically implements the execution and verification of the Program and Erase operations. The Status Read function is used to monitor the Ready/Busy status of the device, determine the result (pass/fail) of a Program or Erase operation, and determine whether the device is in Protect mode. The device status is output via the I/O port on the RE clock after a "70H" command input. The resulting information is outlined in Table 5.

Table 5. Status output table

	STATUS	OUTPUT	
I/O1	Pass/Fail	Pass: 0	Fail: 1
I/O2	Not Used	0	
I/O3	Not Used	0	
I/O4	Not Used	0	
I/O5	Not Used	0	
I/O6	Not Used	0	
I/O7	Ready/Busy	Ready: 1	Busy: 0
I/O8	Write Protect	Protect: 0	Not Protected: 1

The Pass/Fail status on I/O1 is only valid when the device is in the Ready state.

An application example with multiple devices is shown in Figure 6.

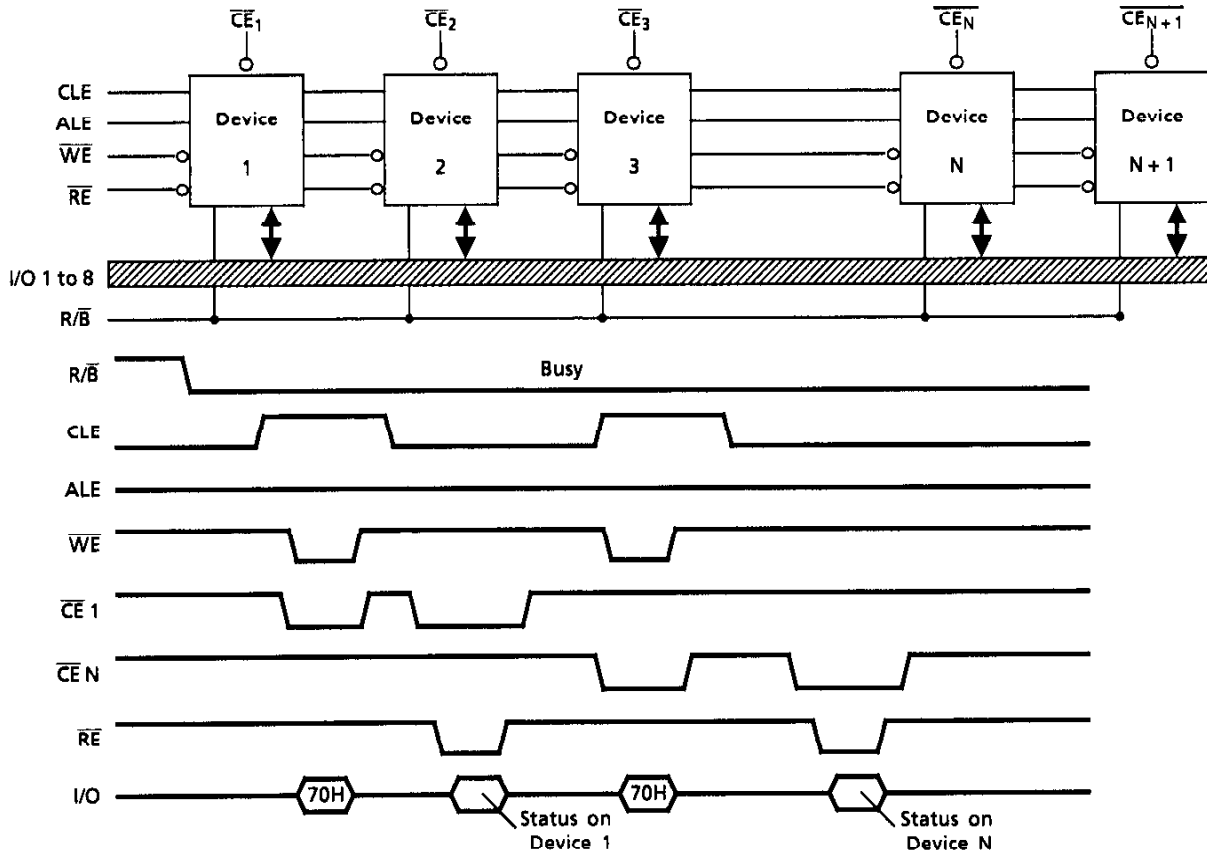

Figure 6. Status Read timing application example

System Design Note: If the R/B pin signals from multiple devices are wired together as shown in the diagram, the Status Read function can be used to determine the status of each individual device.

Auto Page Program

The device carries out an Automatic Page Program operation when it receives a "10H" Program command after the address and data have been input. The sequence of command, address and data input is shown below. (Refer to the detailed timing chart.)

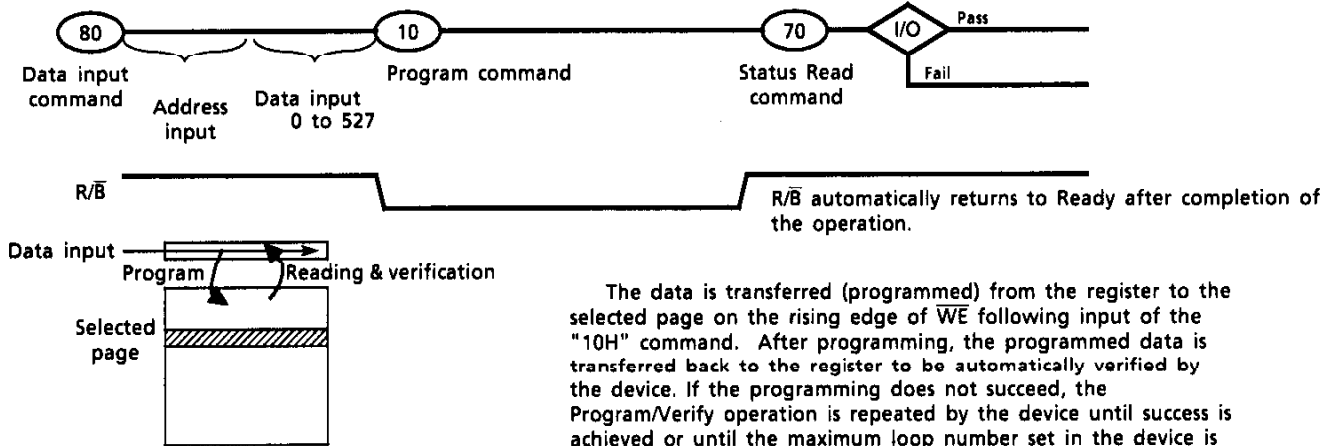
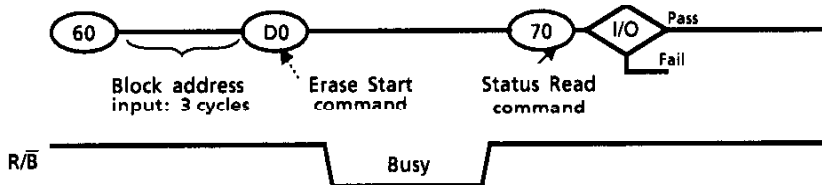

Figure 7. Auto Page Program operation

Auto Block Erase

The Auto Block Erase operation starts on the rising edge of  $\overline{WE}$  after the Erase Start command "D0H" which follows the Erase Setup command "60H". This two-cycle process for Erase operations acts as an extra layer of protection from accidental erasure of data due to external noise. The device automatically executes the Erase and Verify operations.



**Reset**

The Reset mode stops all operations. For example, in the case of a Program or Erase operation the internally generated voltage is discharged to 0 volts and the device enters Wait state. The address and data registers are set as follows after a Reset:

- Address Register: All "0"
- Data Register: All "1"
- Operation Mode: Wait state

The response to an "FFH" Reset command input during the various device operations is as follows:

· When a Reset (FFH) command is input during programming

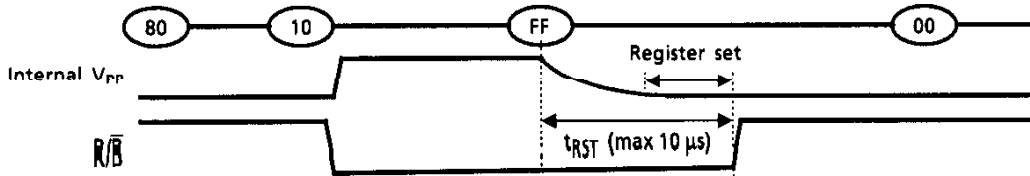

Figure 8.

· When a Reset (FFH) command is input during erasing

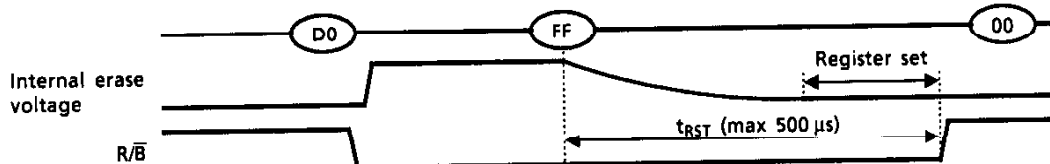

Figure 9.

· When a Reset (FFH) command is input during a Read operation

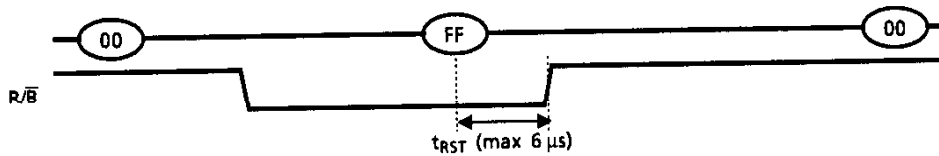

Figure 10.

· When a Status Read command (70H) is input after a Reset

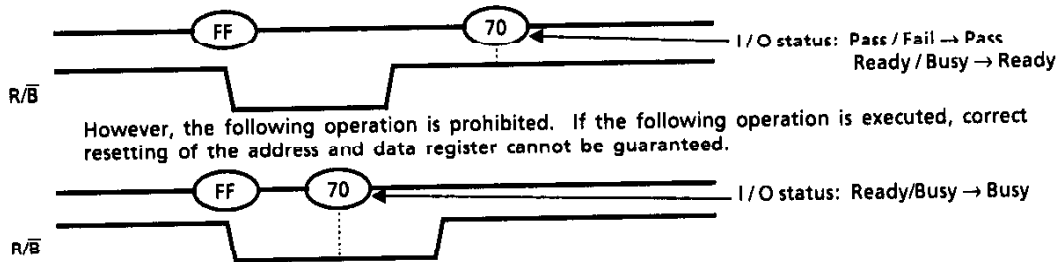

Figure 11.

· When two or more Reset commands are input in succession

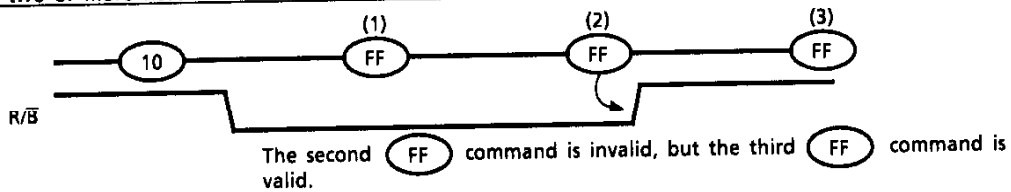
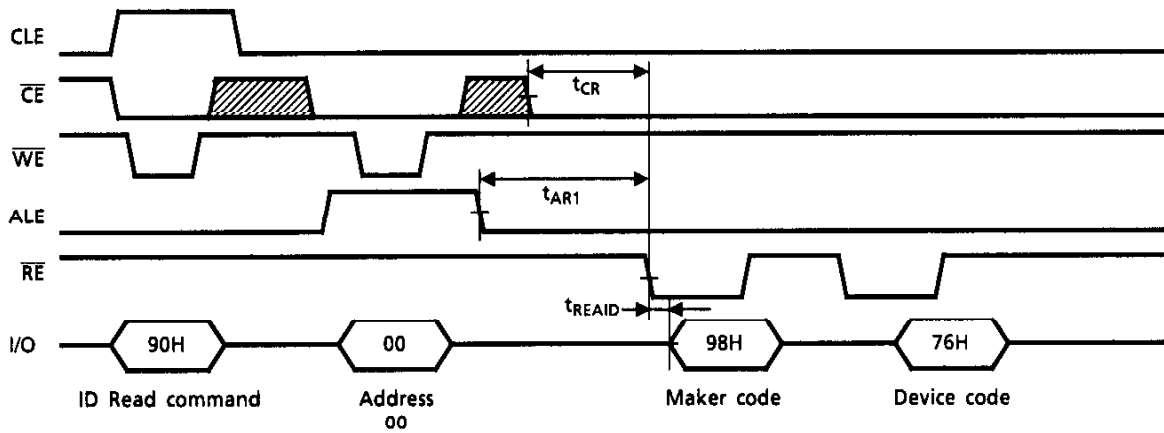

Figure 12.

ID Read

The TH58512 contains ID codes which identify the device type and the manufacturer. The ID codes can be read out under the following timing conditions:



For the specifications of the access times  $t_{READ}$ ,  $t_{CR}$  and  $t_{AR1}$  refer to the AC Characteristics.

Figure 13. ID Read timing

Table 6. Code table

	I/O8	I/O7	I/O6	I/O5	I/O4	I/O3	I/O2	I/O1	Hex Data
Maker code	1	0	0	1	1	0	0	0	98H
Device code	0	1	1	1	0	1	1	0	76H



**APPLICATION NOTES AND COMMENTS**

(1) Prohibition of unspecified commands

The operation commands are listed in Table 3. Input of a command other than those specified in Table 3 is prohibited. Stored data may be corrupted if an unknown command is entered during the command cycle.

(2) Restriction of command while Busy state

During Busy state, do not input any command except 70H and FFH.

(3) Pointer control for "00H", "01H" and "50H"

The device has three Read modes which set the destination of the pointer. Table 7 shows the destination of the pointer, and Figure 14 is a block diagram of their operations.

Table 7. Pointer Destination

Read Mode	Command	Pointer
(1)	00H	0 to 255
(2)	01H	256 to 511
(3)	50H	512 to 527

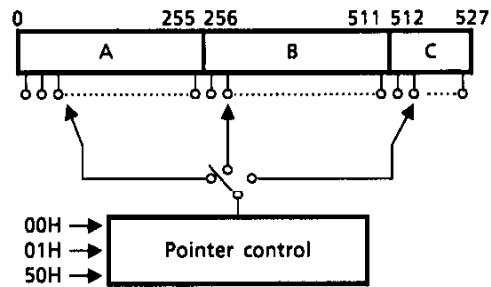
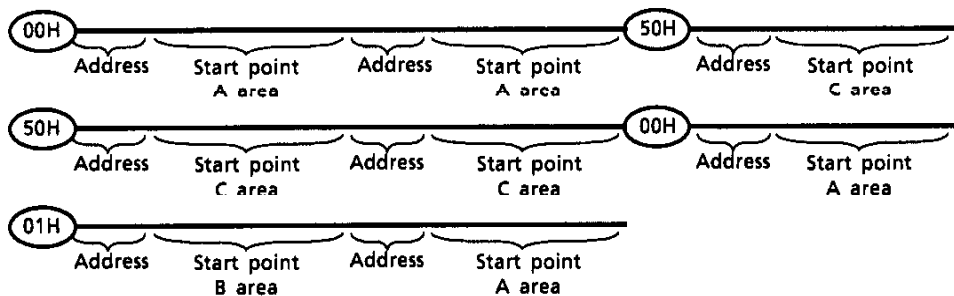

Figure 14. Pointer control

The pointer is set to region A by the "00H" command, to region B by the "01H" command, and to region C by the "50H" command.

(Example)

The "00H" command must be input to set the pointer back to region A when the pointer is pointing to region C.



To program region C only, set the start point to region C using the 50H command.

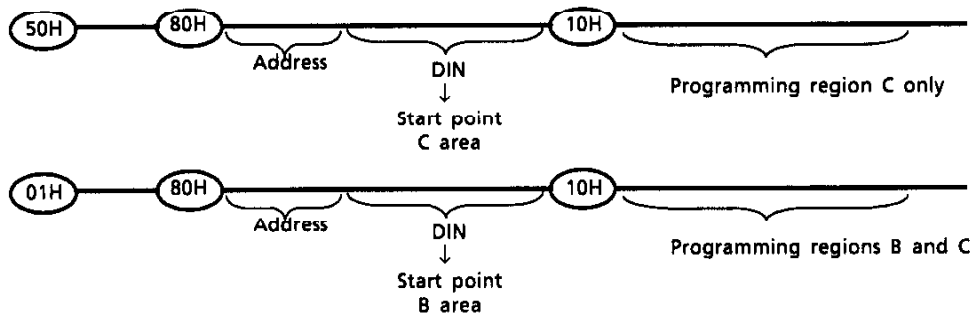

Figure 15. Example of How to Set the Pointer

(4) Acceptable commands after Serial Input command "80H"

Once the Serial Input command "80H" has been input, do not input any command other than the Program Execution command "10H" or the Reset command "FFH".

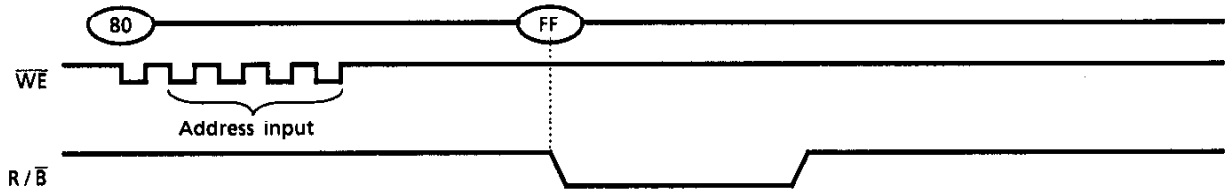
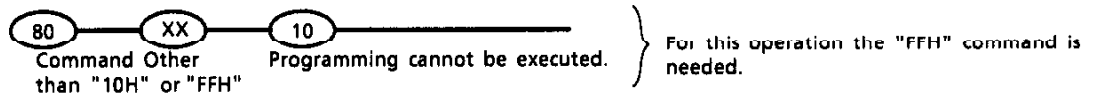

Figure 16.

If a command other than "10H" or "FFH" is input, the Program operation is not performed.



(5) Status Read during a Read operation

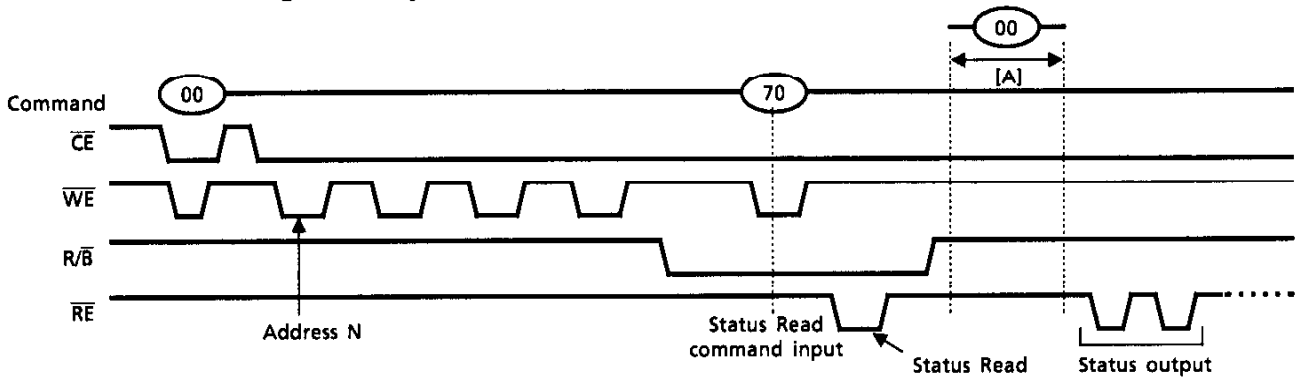

Figure 17.

The device status can be read out by inputting the Status Read command "70H" in Read mode. Once the device has been set to Status Read mode by a "70H" command, the device will not return to Read mode.

Therefore, a Status Read during a Read operation is prohibited.

However, when the Read command "00H" is input during [A], Status mode is reset and the device returns to Read mode. In this case, data output starts automatically from address N and address input is unnecessary.

(6) Auto programming failure

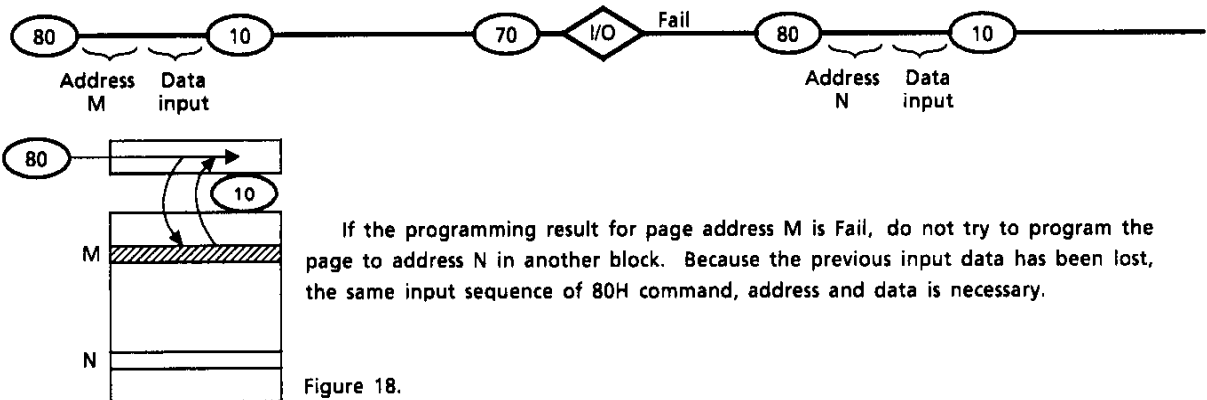

Figure 18.

(7)  $R/\bar{B}$ : termination for the Ready/Busy pin ( $R/\bar{B}$ )

A pull-up resistor needs to be used for termination because the  $R/\bar{B}$  buffer consists of an open drain circuit.

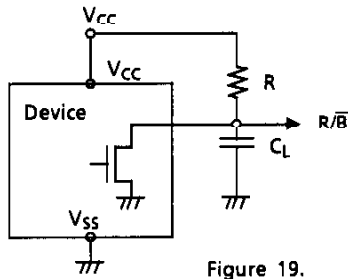
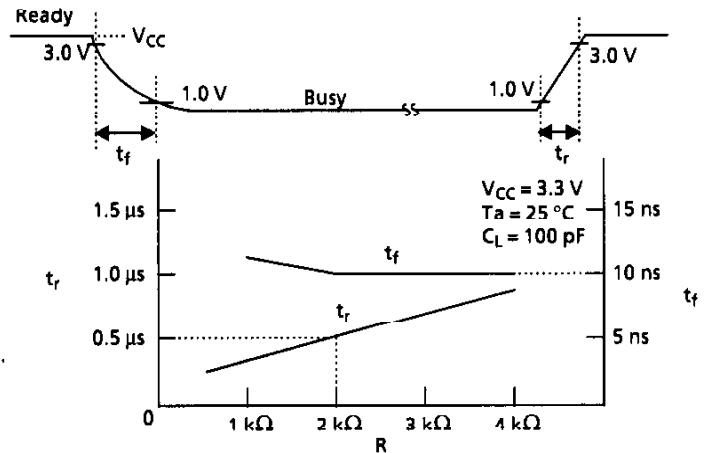

Figure 19.

This data may vary from device to device. We recommend that you use this data as a reference when selecting a resistor value.



(8) Status after power-on

The following sequence is necessary because some input signals may not be stable at power-on.

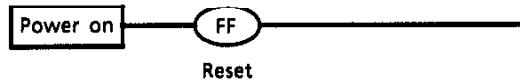

Figure 20.

(9) Power-on/off sequence:

The  $\bar{WP}$  signal is useful for protecting against data corruption at power-on/off. The following timing sequence is necessary:

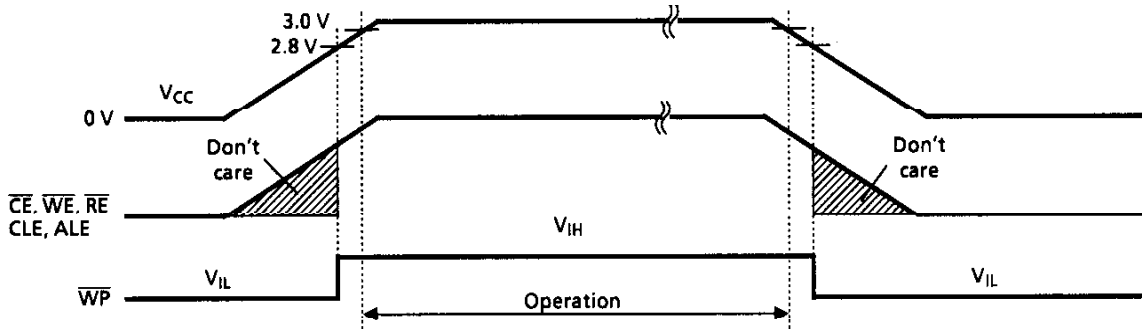
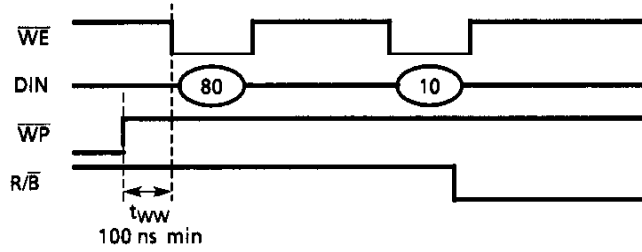

Figure 21. Power-on/off Sequence

(10) Note regarding the  $\overline{WP}$  signal

The Erase and Program operations are automatically reset when  $\overline{WP}$  goes Low. The operations are enabled and disabled as follows:

Enable Programming



Disable Programming

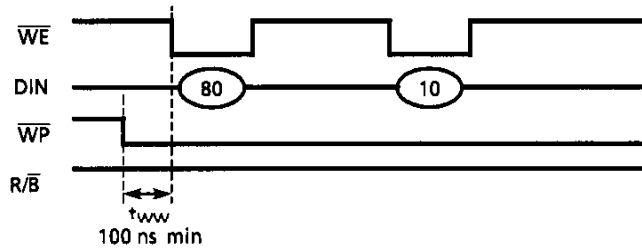

Enable Erasing

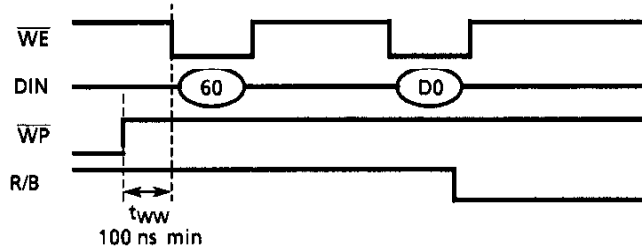

Disable Erasing

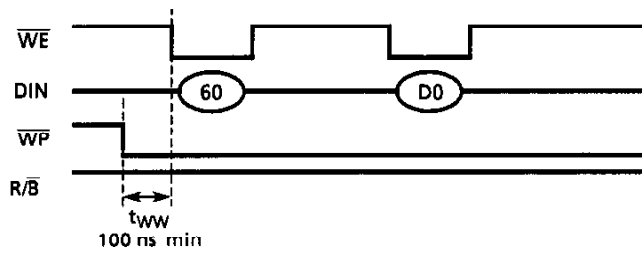

- (11) When four address cycles are input  
 Although the device may read in a fourth address, it is ignored inside the chip.

Read operation

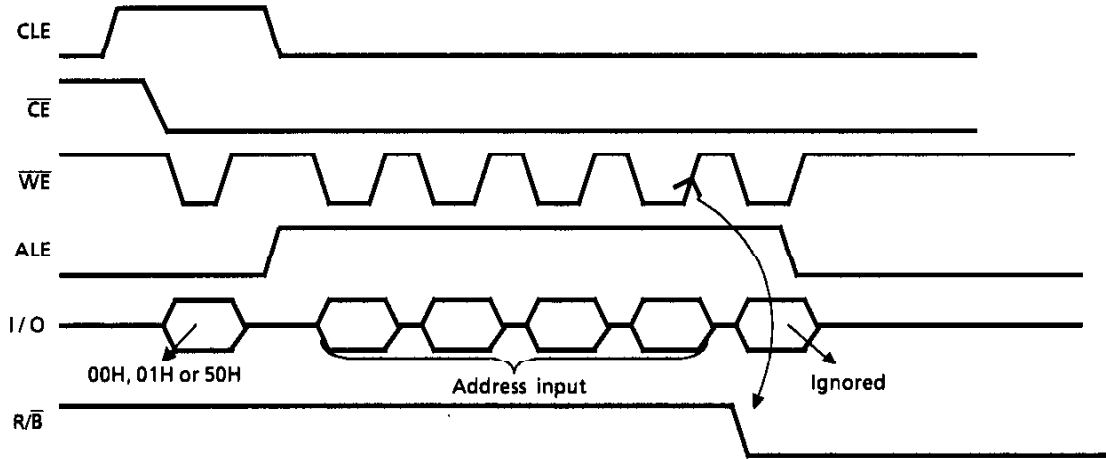

Internal read operation starts when  $\overline{WE}$  goes High in the third cycle.

Figure 22.

Program operation

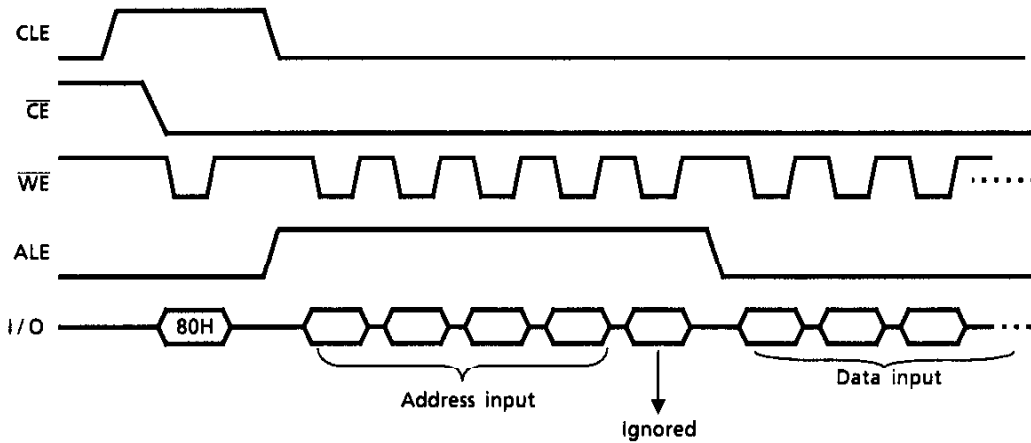

Figure 23.

(12) Several programming cycles on the same page (Partial Page Program)

A page can be divided into up to 10 segments. Each segment can be programmed individually as follows:

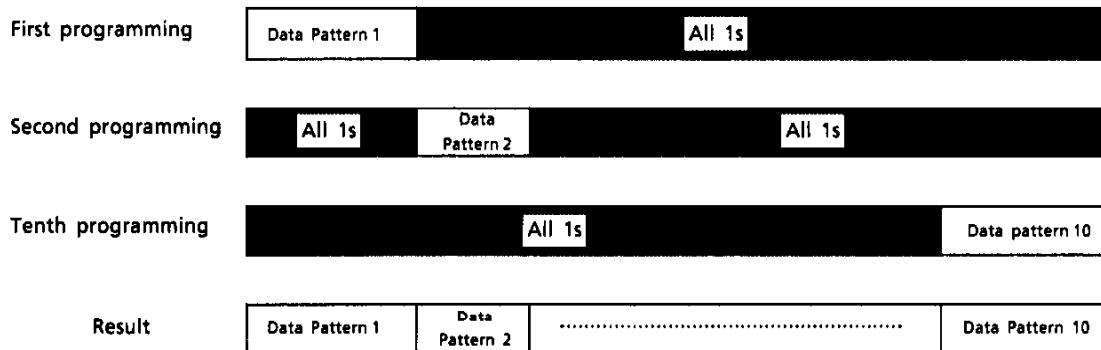

Figure 24.

Note: The input data for unprogrammed or previously programmed page segments must be "1" (i.e. the inputs for all page bytes outside the segment which is to be programmed should be set to all "1").

(13) Note regarding the  $\overline{RE}$  signal

The internal column address counter is incremented synchronously with the  $\overline{RE}$  clock in Read mode. Therefore, once the device has been set to Read mode by a "00H", "01H" or "50H" command, the internal column address counter is incremented by the  $\overline{RE}$  clock independently of the address input timing. If the  $\overline{RE}$  clock input pulses start before the address input, and the pointer reaches the last column address, an internal read operation (array → register) will occur and the device will enter Busy state. (Refer to Figure 25.)

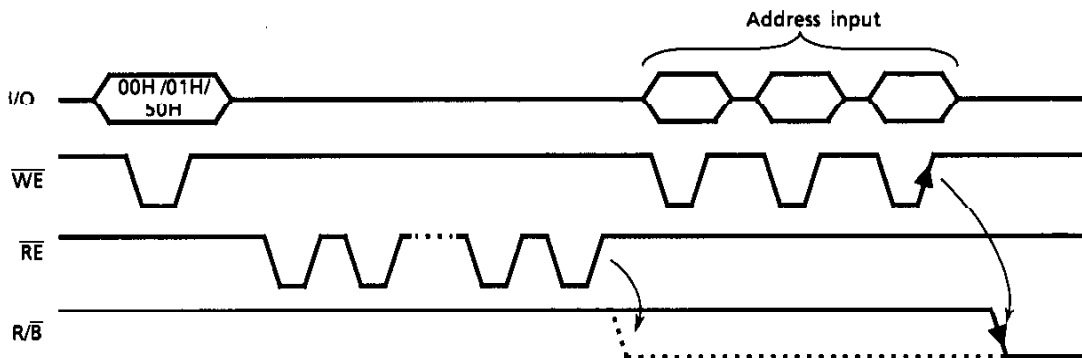

Figure 25.

Hence the  $\overline{RE}$  clock input must start after the address input.

(14) Invalid blocks (bad blocks)

The device contains unusable blocks. Therefore, the following issues must be recognized:

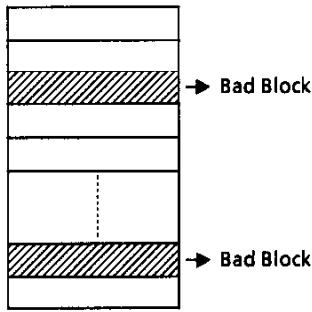

Figure 26.

Referring to the Block status area in the redundant area allows the system to detect bad blocks in the accordance with the physical data format issued by the SSFDC Forum. Detect the bad blocks by checking the Block Status Area at the system power-on, and do not access the bad blocks in the following routine.

The number of valid blocks at the time of shipment is as follows:

	MIN	TYP	MAX	UNIT
Valid (Good) Block Number	4016	—	4096	Block

(15) Failure phenomena for Program and Erase operations

The device may fail during a Program or Erase operation.

The following possible failure modes should be considered when implementing a highly reliable system.

FAILURE MODE		DETECTION AND COUNTERMEASURE SEQUENCE
Block	Erase Failure	Status Read after Erase → Block Replacement
Page	Programming Failure	Status Read after Program → Block Replacement
Single Bit	Programming Failure "1 → 0"	(1) Block Verify after Program → Retry
		(2) ECC

- ECC : Error Correction Code
- Block Replacement

Program

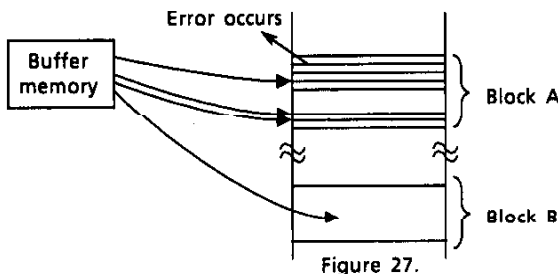

Figure 27.

When an error happens in Block A, try to reprogram the data into another (Block B) by loading from an external buffer. Then, prevent further system accesses to Block A ( by creating a bad block table or by using an another appropriate scheme).

Erase

When an error occurs for an Erase operation, prevent future accesses to this bad block (again by creating a table within the system or by using another appropriate scheme).

(16) Chattering of Connector

There may be contact chattering when the TH58512DC is inserted or removed from a connector.

This chattering may cause damage to the data in the TH58512DC. Therefore, sufficient time must be allowed for contact bouncing to subside when a system is designed with SmartMedia™.

(17) The TH58512DC is formatted to comply with the Physical and Logical Data Format of the SSFDC Forum at the time of shipping.

**Handling Precaution**

- (1) Avoid bending or subjecting the card to sudden impact.
- (2) Avoid touching the connectors so as to avoid damage from static electricity.  
This card should be kept in the antistatic film case when not in use.
- (3) Toshiba cannot accept, and hereby disclaims liability for, any damage to the card including data corruption that may occur because of mishandling.

**SSFDC Forum**

The SSFDC Forum\*1 is a voluntary organization intended to promote the SmartMedia™, a small removable NAND flash memory card. The SSFDC Forum standardized the following specifications in order to keep the compatibility of SmartMedia™ in systems. The latest specifications issued by the Forum must be referenced when a system is designed with SmartMedia™, especially with large capacity SmartMedia™\*2.

The major specifications issued by the Forum as of March 1998 are as follows (These specify 1Mbyte to 128Mbyte SmartMedia™).

SmartMedia™ Electrical Specifications Ver.1.10\*3  
SmartMedia™ Physical Format Specification Ver.1.20  
SmartMedia™ Logical Format Specification Ver.1.10

- \*1: The flash memory card SSFDC (Solid State Floppy Disk Card) was renamed to SmartMedia™ in July 1996.
- \*2: The Physical Format of 32MByte and larger SmartMedia™ has a modification from that of the smaller capacity SmartMedia™.
- \*3: Some electrical specifications in this data sheet show differences from the Forum's electrical specification. complying with the Forum's electrical specification maintains compatibility with other SmartMedias.

The SSFDC Forum can be contacted by accessing the Forum's home page.

**URL <http://www.ssfdc.or.jp>**



**PACKAGE DIMENSIONS**

FDC-22C

Unit: mm

