



LA3450

PLL FM MPX Stereo Demodulator with Adjustment-Free VCO and Measure Against Adjacent Channel Interference

Overview

The LA3450 is a multifunctional, high-performance FM multiplex demodulator IC designed for high-grade FM stereo tuner use. The LA3450 features adjustment-free VCO, measure against adjacent channel interference, pilot canceler, low distortion (0.005%), and high S/N (101dB).

Applications

- Home stereo, CD, AV-use PLL FM MPX stereo demodulator IC with adjustment-free VCO.

Functions

- PLL multiplex stereo demodulator.
- Adjustment-free VCO.
- Measure against adjacent channel interference.
- Pilot canceler.
- Cal-tone signal generator.
- AM/FM input, AM/FM selector.
- Post amplifier (gain variable type).
- VCO stop.
- Right/left independent adjustment of separation (single adjustment available).

Features

- Adjustmet-free VCO : Eliminates the need to adjust free-running frequency.
- Good temperature characteristics of VCO : $\pm 0.1\%$ typ. for $\pm 50^\circ\text{C}$ change.
- No antibirdie filter is required because a measure is taken against adjacent channel interference.
- Less carrier leak 19kHz : 53dB 38kHz : 50dB
- The on-chip cal-tone signal generator facilitates application of recording calibrator.
- Low distortion MONO 0.005% STEREO 0.015%
- High S/N 101dB typ. MONO IHF-A BPF
- High voltage gain FM : 10dB (gain variable)
AM : 16dB (gain variable)
- Wide dynamic range Output level 3.3V typ. (THD=1%, MONO)

Package Dimensions

unit:mm

3029A-DIP28S

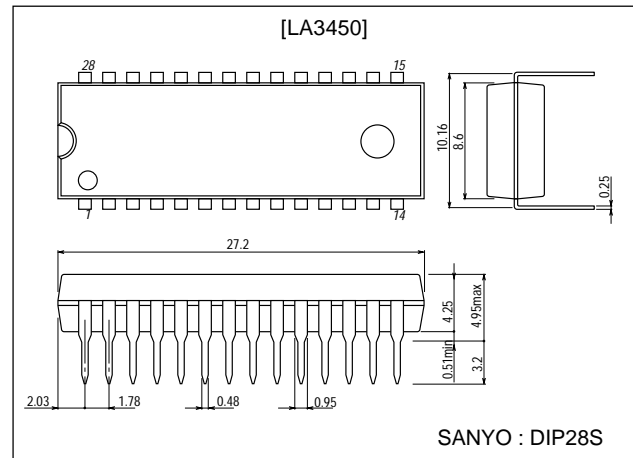

■ Any and all SANYO products described or contained herein do not have specifications that can handle applications that require extremely high levels of reliability, such as life-support systems, aircraft's control systems, or other applications whose failure can be reasonably expected to result in serious physical and/or material damage. Consult with your SANYO representative nearest you before using any SANYO products described or contained herein in such applications.

■ SANYO assumes no responsibility for equipment failures that result from using products at values that exceed, even momentarily, rated values (such as maximum ratings, operating condition ranges, or other parameters) listed in products specifications of any and all SANYO products described or contained herein.

SANYO Electric Co., Ltd. Semiconductor Company

TOKYO OFFICE Tokyo Bldg., 1-10, 1 Chome, Ueno, Taito-ku, TOKYO, 110-8534 JAPAN

21500TH (KT)/2187TA No.2393-1/15

Specifications

Absolute Maximum Ratings at Ta = 25°C

Parameter	Symbol	Conditions	Ratings	Unit
Maximum Supply Voltage	V _{CC} max		16	V
Lamp Drive Current	I _L max		30	mA
Allowable Power Dissipation	Pd max		680	mW
Operating Temperature	Topr		-20 to +70	°C
Storage Temperature	Tstg		-40 to +125	°C

Operating Conditions at Ta = 25°C

Parameter	Symbol	Conditions	Ratings	Unit
Recommended Supply Voltage	V _{CC}		13	V
Operating Voltage	V _{CC} op		10 to 15	V
Recommended Input Signal Voltage	V _i		400	mV

Electrical Characteristics at Ta = 25°C, V_{CC}=13V, Input : 400mV, f=1kHz, L+R=90%, pilot=10%

Parameter	Symbol	Conditions	Ratings			Unit
			min	typ	max	
Quiescent Current	I _{cco}	No input		29	39	mA
Input Resistance	r _i	FM, AM input common	14	20	26	kΩ
Channel Separation	Sep	f=100Hz		50		dB
		f=1kHz	45	60		dB
		f=10kHz		50		dB
Total Harmonic Distortion	THD	FM MONO		0.005	0.05	%
		FM MAIN		0.015	0.08	%
		AM 200mV input		0.02	0.08	%
Allowable Input Level	V _{in} max	FM MONO, THD=1%	800	1200		mV
		AM	400	600		mV
Output Voltage	V _o	FM MONO	770	1100	1500	mV
		AM 200mV input	770	1100	1500	mV
Signal-to-Noise Ratio	S/N	MONO IHF-A BPF	90	101		dB
Birdie Noise Rejection	BR	Spurious signal, VS=100mV, fs=115kHz		40		dB
19kHz Carrier Leak	CL ₁₉	Canceler, de-emphasis		53		dB
38kHz Carrier Leak	CL ₃₈	De-emphasis		50		dB
Crosstalk	CT	AM → FM, AM input 200mV	70	80		dB
		FM → AM, FM input 400mV	70	80		dB
Channel Balance	CB	FM MONO		0	1	dB
Cal-tone OSC Frequency				400		Hz
AM/FM Select Voltage	V _{AM-FM}	AM → FM, voltage applied to pin26			0.5	V
		FM → AM, voltage applied to pin26	2.5			V
VCO Stop Voltage		Voltage applied to pin10	2.5			V
Lamp Lighting Level	V _L	PILOT LEVEL	4	7.5	13	mV
Lamp Hysteresis	hy			3.5		dB
Capture Range (Note 1)		PILOT 30mV		±1.2		%

(Note 1) : The capture range is represented by the value in 19kHz equivalent.

(Note 2) : The low-pass filter used to measure electrical characteristics must have 19kHz attenuation of -90dB or more negative value of dB and 38kHz attenuation of -70dB or more negative value of dB.

(Note 3) : Be carefull that the combination of pin 22 ⊕ and the others causes dielectric breakdown easily.

LA3450

Internal Block Diagram

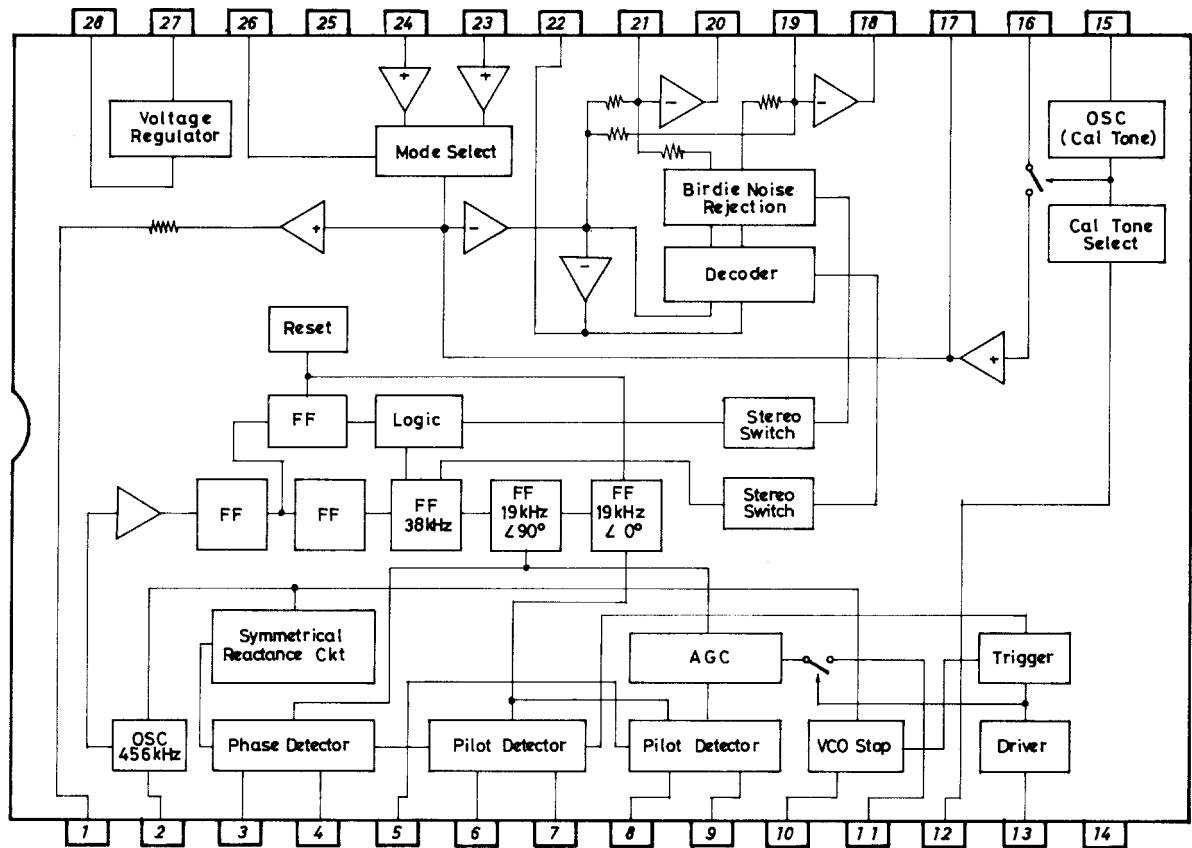

Typical Value of Voltage on Each Pin and Pin Name

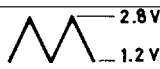
Pin No.	Typ. Value	Pin Name	Remarks
1	5.7V	Composite amplifier output	Output resistance 1kΩ
2	-	OSC	 4.3V 2.3V f≈456kHz
3	2.6V	Loop filter	
4	2.6V	Loop filter	
5	2.6V	PLL input	
6	2.6V	Pilot sync detection filter	
7	2.6V	Pilot sync detection filter	
8	2.6V	Pilot sync detection filter	For pilot cancel
9	2.6V	Pilot sync detection filter	For pilot cancel
10	-	VCO stop	Input resistance 120kΩ
11	-	Pilot cancel	Triangular wave output, level follow-up
12	3.8V	Cal-tone control	Pin voltage is represented by voltage at ON state.
13	-	Stereo indicator	Open collector
14	0	GND	
15	-	Cal-tone OSC output	 2.8V 1.2V f≈400Hz
16	5.7V	Cal-tone input	
17	5.7V	Pilot cancel input	
18	5.7V	Post amplifier output	L output
19	5.7V	Post amplifier input	L input, (-) input
20	5.7V	Post amplifier output	R output
21	5.7V	Post amplifier input	R input, (-) input
22	5.7V	Separation adjustment	
23	5.7V	AM input	Input resistance 20kΩ

Continued on next page.

LA3450

Continued from preceding page.

Pin No.	Typ. Value	Pin Name	Remarks
24	5.7V	FM input	Input resistance 20kΩ
25	0	Signal GND	
26	-	AM/FM selection	Input resistance 120kΩ
27	5.7V	Vref	Reference voltage
28	V _{CC}	Power supply	

Sample Application Circuit (1)

Input separation ≥ 0.92

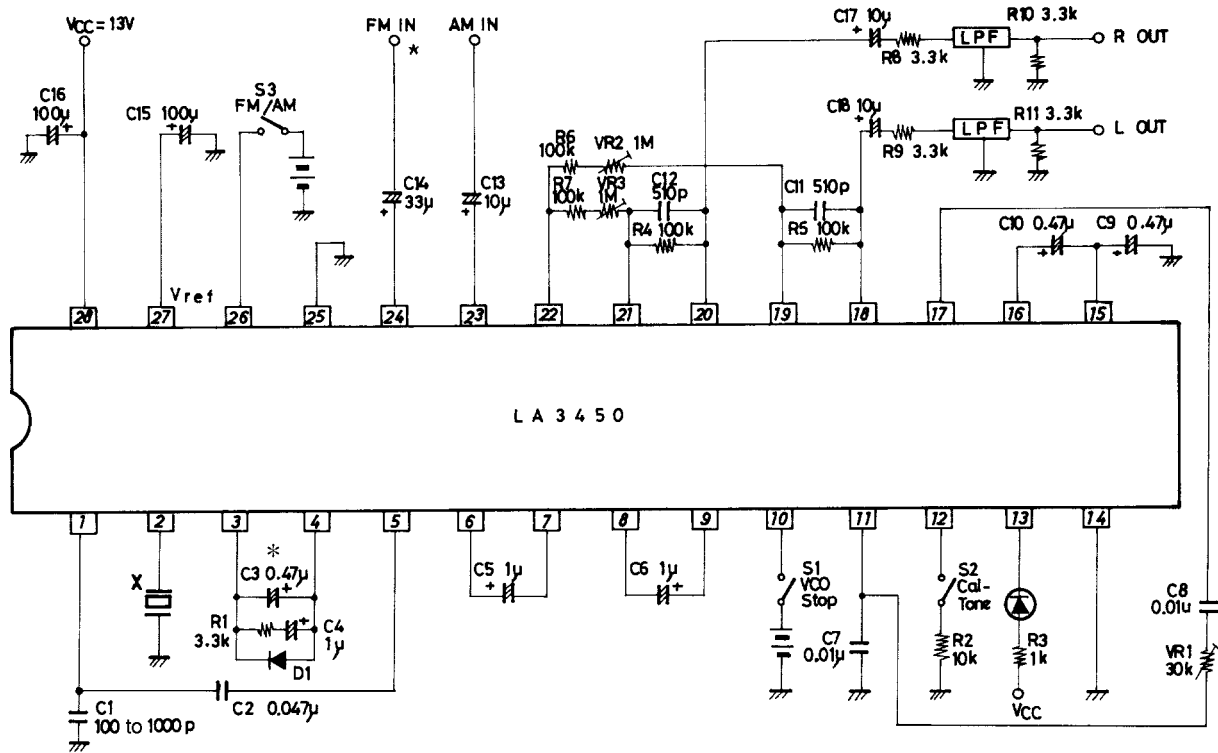

Unit (resistance: Ω, capacitance: F)

X : CSB456F11 (Murata)

KBR-457HS (Kyocera)

* : Input pilot level 20mV or greater : 0.47μF

14mV or greater : 0.22μF

8mV or greater : C3=0.1μF, R1=6.8kΩ, C4=0.47μF

* : Input separation (sub signal/main signal) ≥ 0.92 (f=1kHz)

How to Make Single Adjustmet of Separation

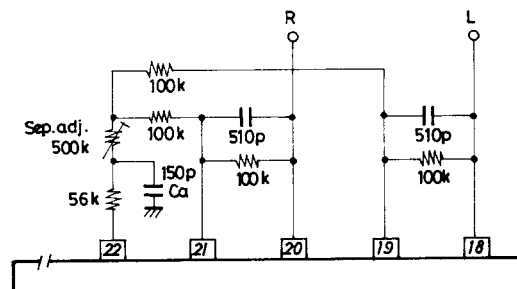

Unit (resistance: Ω, capacitance: F)

LA3450

Sample Application Circuit (2)

Input separation ≤ 0.92

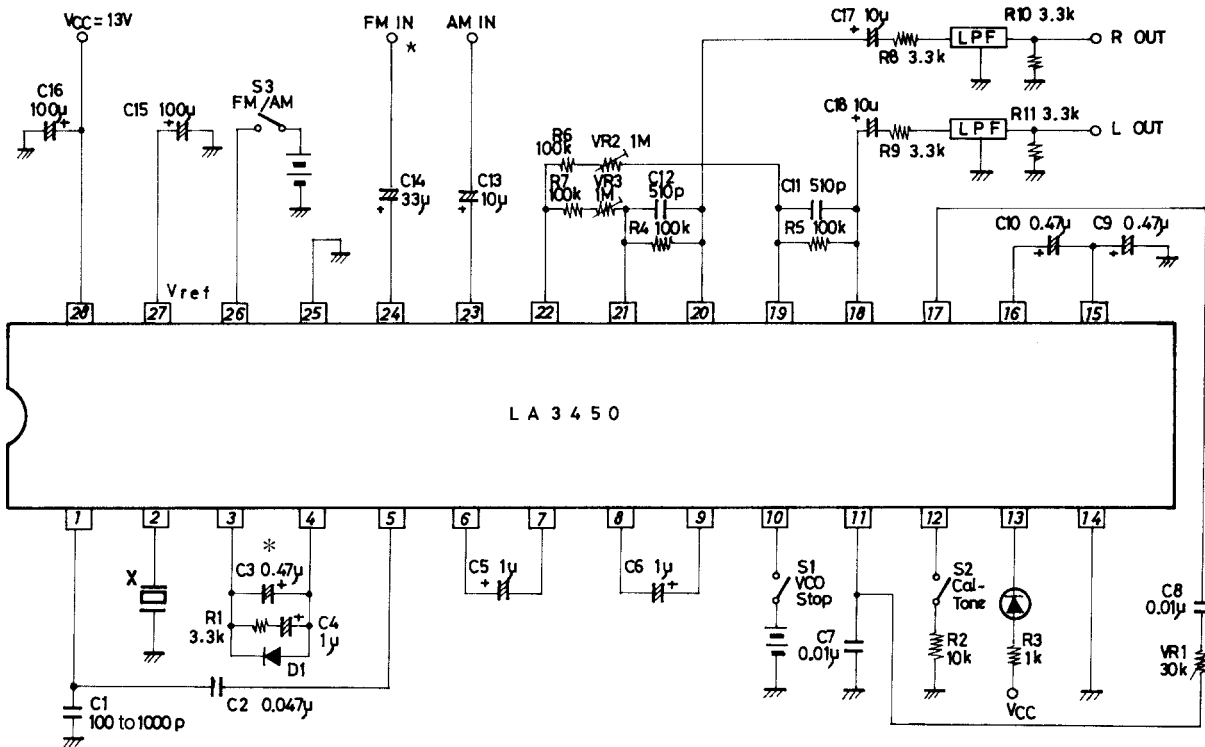

Unit (resistance: Ω , capacitance: F)

X : CSB456F11 (Murata)

KBR-457HS (Kyocera)

* : Input pilot level 20mV or greater : 0.47µF

14mV or greater : 0.22µF

8mV or greater : C3=0.1µF, R1=6.8k Ω , C4=0.47µF

* : Input separation (sub signal/main signal) ≥ 0.92 (f=1kHz)

How to Make Single Adjustmet of Separation

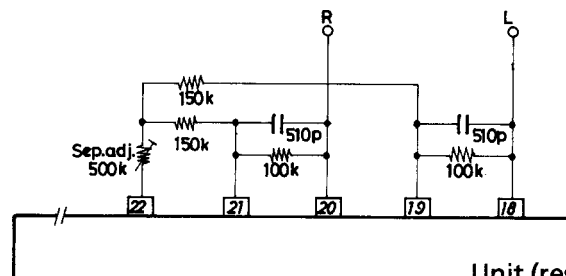

Unit (resistance: Ω , capacitance: F)

LA3450

Sample Application Circuit (3)

Pilot sine wave cancel

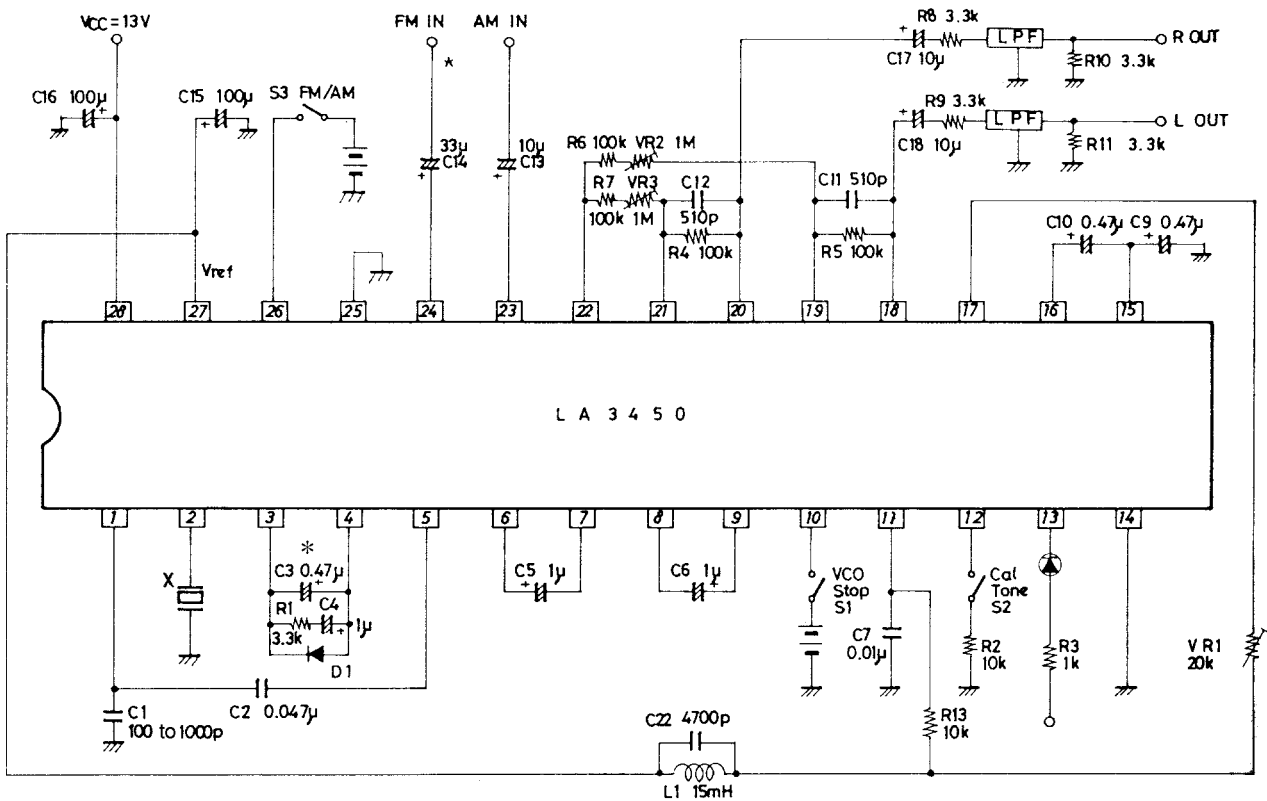

Unit (resistance: Ω , capacitance: F)

X : CSB456F11 (Murata)

KBR-457HS (Kyocera)

* : Input pilot level 20mV or greater : 0.47 μ F

14mV or greater : 0.22 μ F

8mV or greater : C3=0.1 μ F, R1=6.8k Ω , C4=0.47 μ F

* : Input separation (sub signal/main signal) ≤ 0.92 (f=1kHz)

For the separation adjusting method when the input separation is more than 0.92, see Sample Application Circuit (2).

(Note 1) In this Sample Application Circuit, the DC voltage on pins 11, 17 is almost equal to that on pin 27 and no DC cut capacitor (C8 in Sample Application Circuit (1), (2)) is required.

LA3450

Description of External Parts

Name	Symbol	Kind	Value	Remarks	
Capacitor	C1	Ceramic	100 to 1000pF (Note1)	Improvement in stereo low-frequency distortion	
	C2	Polyester film	0.047 μ F	DC cut	
	C3	Electrolytic	0.1 to 0.47 μ F	Loop filter, Input pilot 8mV or greater : 0.1 μ F 14mV or greater : 0.22 μ F 20mV or greater : 0.47 μ F	
	C4	Electrolytic	0.47 μ F to 1 μ F	Loop filter, Input pilot 8mV or greater : 0.47 μ F 14mV or greater : 1 μ F	
	C5	Electrolytic	1 μ F	Sync detection filter	
	C6	Electrolytic	1 μ F	Sync detection filter	
	C7	Polyester film	0.01 μ F	For integration (generation of triangular wave)	
	C8	Polyester film	0.01 μ F	DC cut	
	C9	Electrolytic	0.47 μ F	For integration (generation of triangular wave)	
	C10	Electrolytic	0.47 μ F	DC cut	
	C11 to 12	Ceramic	510pF	De-emphasis capacitor, R5. C11=50 μ s (75 μ s) R4. C12=50 μ s (75 μ s)	
	C13	Electrolytic	10 μ F	DC cut	
	C14	Electrolytic	33 μ F	DC cut	
	C15	Electrolytic	100 μ F	Filter, S/N improvement	
	C16	Electrolytic	100 μ F	Power filter	
	C17 to 18	Electrolytic	10 μ F	DC cut	
	C19	Ceramic	1000pF	LPF for sub signal attenuation	
	C20 to 21	Ceramic	100pF	Improvement in separation at high frequencies (Note 2)	
	C22	Ceramic	4700pF	19kHz tank circuit (generation of sine wave)	
	Resistor	R1	Carbon	3.3 to 6.8k Ω	Loop filter, Input pilot 8mV or greater : 6.8k Ω 14mV or greater : 3.3k Ω
		R2	Carbon	10k Ω	Fixing of cal-tone OSC frequency
		R3	Carbon	1k Ω	Limiting resistor
R4 to 5		Carbon	100k Ω	Post amplifier feedback resistor, de-emphasis resistor	
R6 to 7		Carbon	100k Ω	For separation adjustment	
R8 to 9		Carbon	3.3k Ω	LPF input resistor (Note 3)	
R10 to 11		Carbon	3.3k Ω	LPF output resistor	
R12		Carbon	2k Ω	LPF for sub signal attenuation	
R13		Carbon	10k Ω	Generation of pilot cancel signal	
Semifixed resistor	VR1	Carbon	30k Ω	Pilot cancel adjustment	
	VR2 to 3	Carbon	1M Ω	Separation adjustment	
Resonator	X	Ceramic		CSB456F11 (Murata), KBR-457HS (Kyocera)	
Diode	D1	Silicon (Low leak)		Improvement in stereo start time after VCO stop release	
Coil	L1		15mH	19kHz tank circuit (generation of sine wave)	

Note 1 : C1 differs with set models. Capacitor used to phase the sub signal of the decoder with the reproduction sub signal in the PLL.

Note 2 : C20 to 21 are set to the optimum value according to each set mode.

Note 3 : The LPF input resistor value is 3.3k Ω or greater.

LA3450

Sample Printed Circuit Pattern

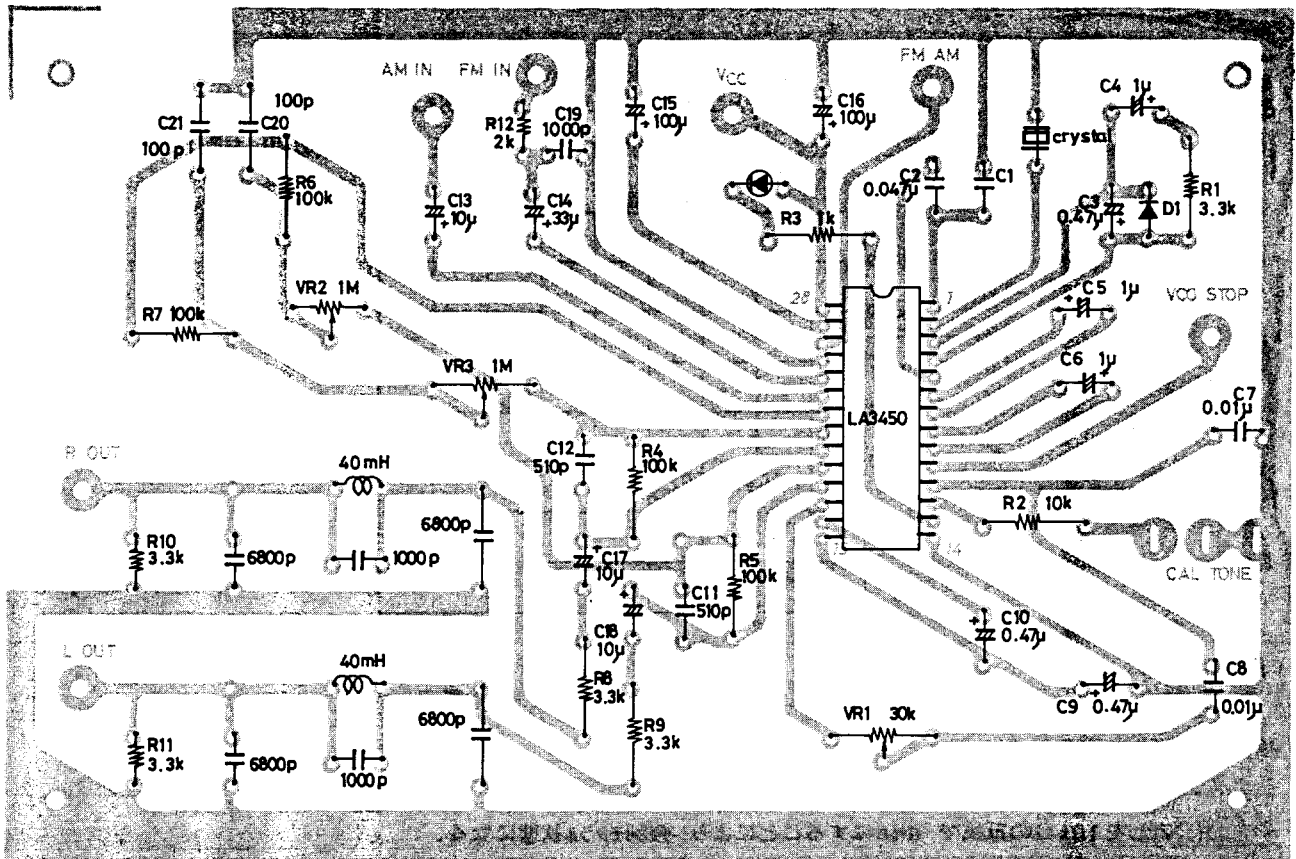

8.5 × 13.0mm²

Unit (resistance: Ω, capacitance: F)

Proper Cares in Applications

1. Ceramic resonator

Shown below are ceramic resonators recommended for use in the LA3450 and their suppliers.

CSB456F11	Murata	Piezoelectric Division
		TEL : 0762-40-2381
KBR-457HS	Kyocera	Electronic Parts Division
		TEL : 075-592-3851

2. Loop filter constants

Loop filter constants (C3, C4, R1) connected to pins 3, 4 must be set to the optimum value according to an input pilot level. The recommended values are shown in Table 1.

Input Pilot Level	C3	C4	R1
20mV or greater	0.47μF	1μF	3.3kΩ
14mV or greater	0.22μF	1μF	3.3kΩ
8mV or greater	0.1μF	0.47μF	6.8kΩ

Table 1. Input Pilot Level – Loop Filter Constants

Note : For example, when the loop filter constants are C3=0.22μF, C4=1μF, R1=3.3kΩ, stereo operation can be performed with an input pilot level of 14mV or greater, even with the temperature characteristics of the OSC circuit, the initial tolerance and secular change of a ceramic resonator considered.

3. VCO stop method

VCO OSC can be stopped and the forced monaural mode is entered by applying a voltage of 2.5V or greater to pin 10. The maximum voltage to be applied to pin 10 is 16V regardless of the voltage on pin 28 (V_{CC} pin). The relation between applied voltage and flow-in current is shown in Fig. 1.

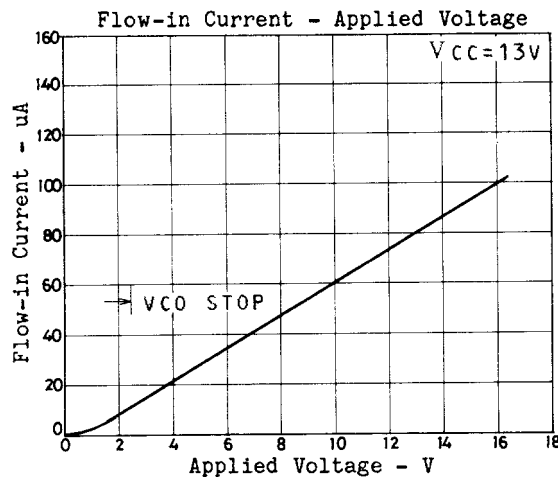

Fig. 1. Voltage Applied to pins 10, 26 – Flow-in Current

4. Forced monaural mode

Connecting pin 16 to GND through a resistor of 10kΩ causes the forced monaural mode to be entered.

5. AM/FM mode select method

The AM/FM mode can be selected by applying a voltage to pin 26. When the voltage on pin 26 is 0.5V or less, the FM mode is entered, and when 2.5V or greater, the AM mode is entered. In AM mode the VCO stops and the forced monaural mode is entered. The relation between voltage on pin 26 and flow-in current is as shown in Fig. 1.

6. Separation adjust method

The separation is adjusted by varying the gain of the main signal with VR2, VR3 as shown in the Sample Application Circuit. Sample Application Circuit (1) or (2) is used according to the attenuation of the input sub signal. When the attenuation ratio of the sub signal to the main signal is 0.92 or greater to 1, use Sample Application Circuit (1), and when 0.92 or less to 1, use Sample Application Circuit (2). Capacitors C20 and C21, which are used to improve the separation characteristic at high frequencies, must be set to the optimum values according to your model set.

7. Cal-tone

The OSC frequency can be set with R2, C9 in the Sample Application Circuit (refer to Fig. 2). The OSC level can be attenuated on connecting resistor Rx across pin 15 and pin 16 (refer to Fig. 3). When the S2 is turned on, the triangular wave generated on pin 15 is amplified by the post amplifier and output. The level at pins 18, 20 is approximately 4V (p-p) when the typical constants are used in the Sample Application Circuit and the output level becomes approximately $4X20 / (Rx+20)$ V (p-p) by connecting Rx.

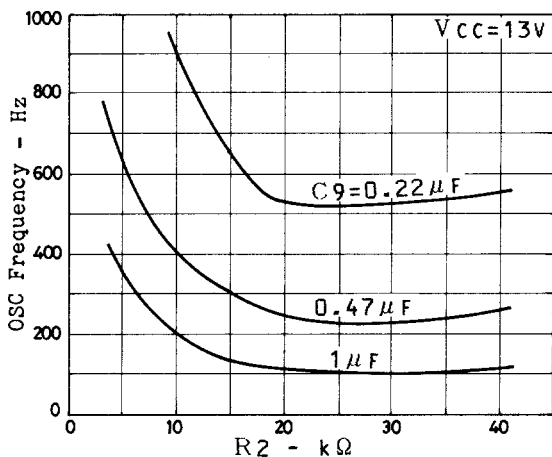

Fig.2. OSC Frequency - R2, C9

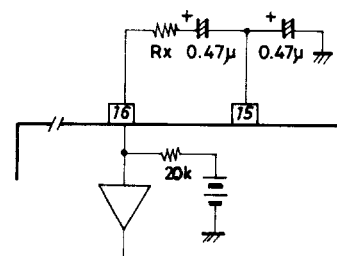

Fig. 3. OSC Level Variable

Unit (resistance: Ω, capacitance: F)

8. $V_O - I_O$ characteristic at pin 27

Fig. 4 shows $V_O - I_O$ characteristic at pin 27 (I_O : Capable of being drawn to the outside)
 Maximum current : 3mA

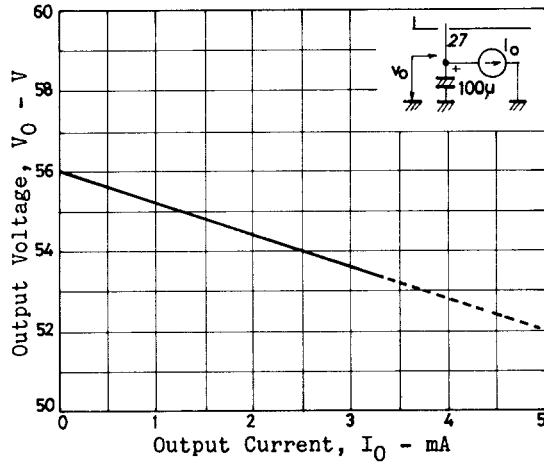

Fig.4. $V_O - I_O$

9. Feedback resistance of post amplifier and total gain, de-emphasis constants

Table 2 shows the feedback resistance of post amplifier and the total gain, de-emphasis constants.

R4 (R5)	Total gain	C12 (C11) 50µs	C12 (C11) 50µs
33kΩ	0dB	1500pF	2200pF
39kΩ	1.5dB	1200pF	2000pF
51kΩ	4dB	1000pF	1500pF
62kΩ	5.5dB	750pF	1200pF
82kΩ	8dB	620pF	910pF
100kΩ	10dB	510pF	750pF
130kΩ	12dB	390pF	560pF
150kΩ	13dB	330pF	510pF
180kΩ	15dB	270pF	390pF

Total gain : At monaural mode, $R4 \cdot C12 = R5 \cdot C11 = 50\mu s, 75\mu s$

Table 2. Feedback resistance of post amplifier and of total gain, de-emphasis constants

10. Low-pass filter

Figs. 5, 6 show a sample circuit configuration and characteristic of the low-pass filter.

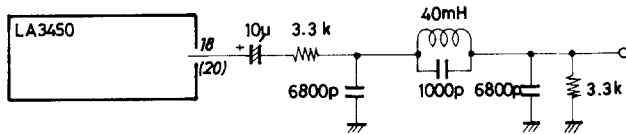

Loss of LPF: Approximately -6dB

Unit (resistance: Ω, capacitance: F)

Fig. 5 Sample Circuit of LC Filter

LA3450

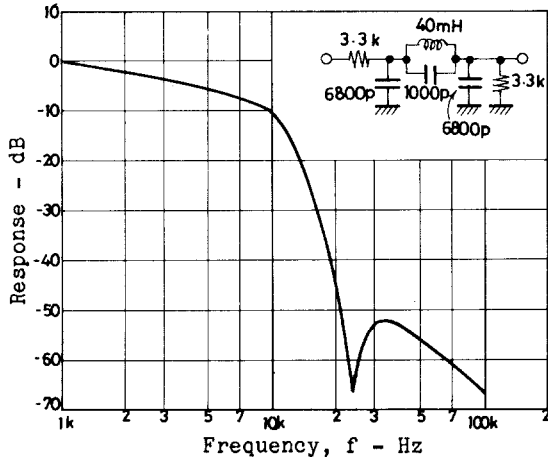
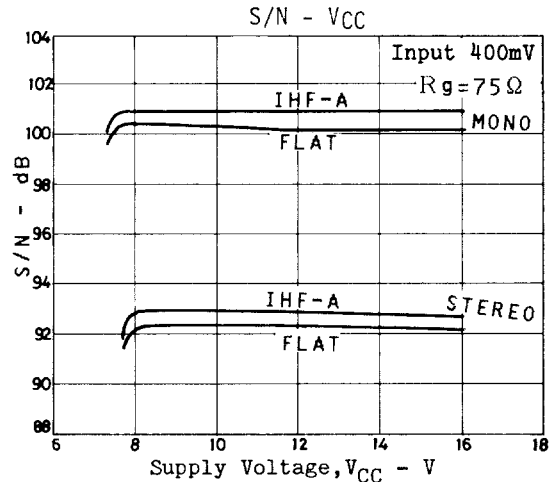
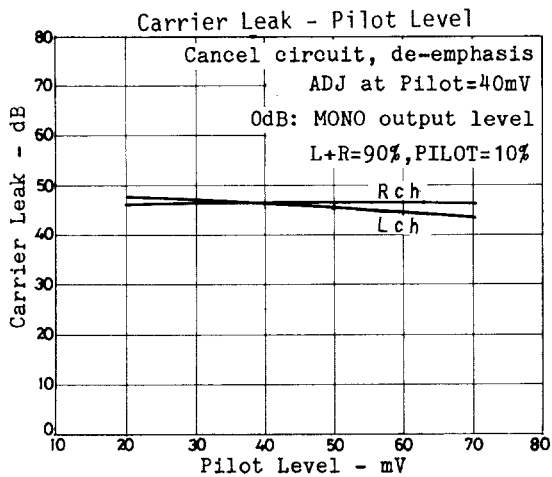
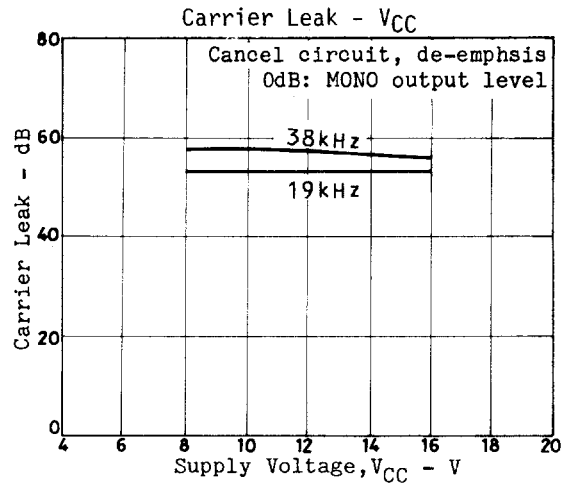
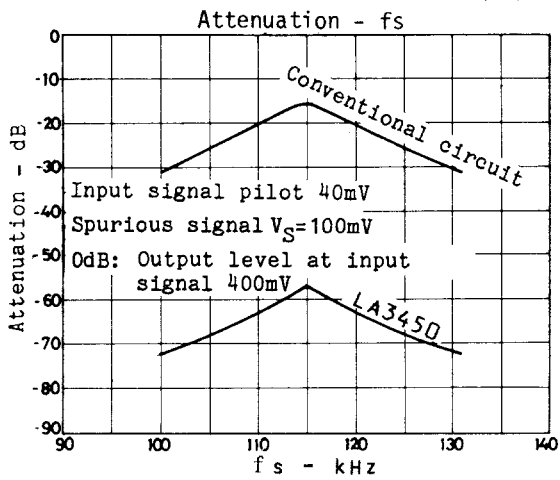
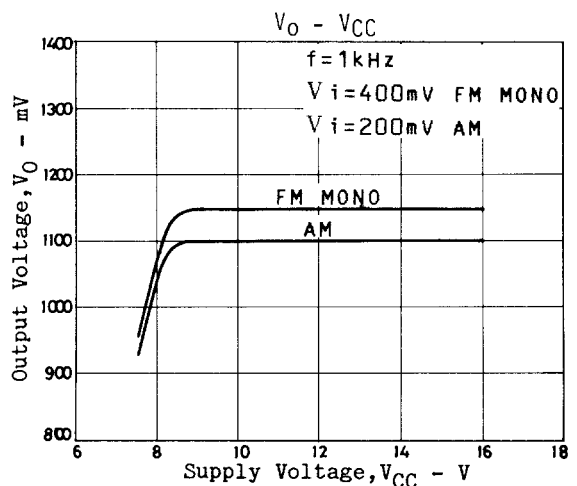
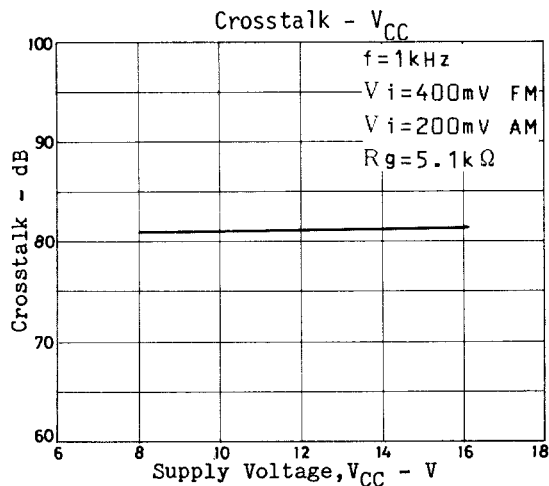
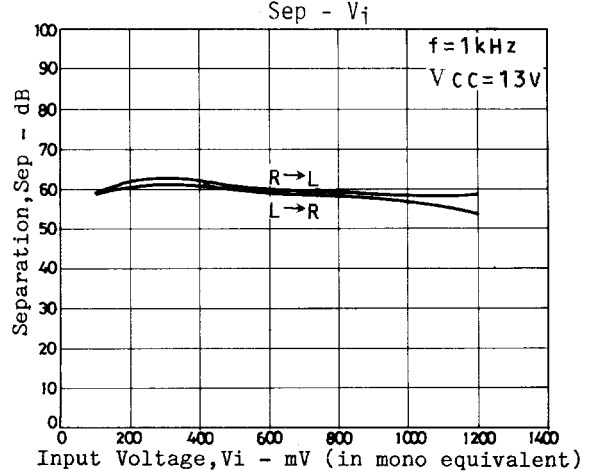
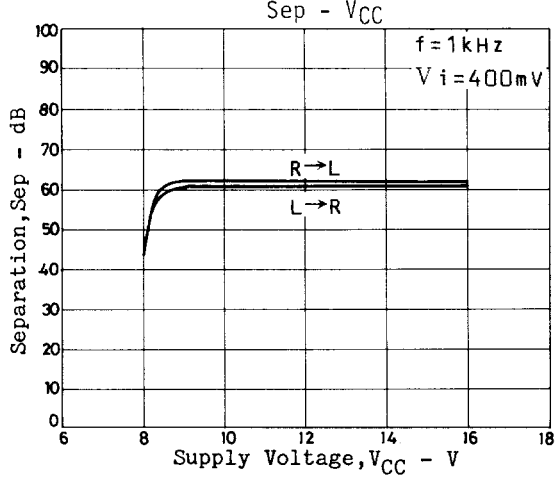
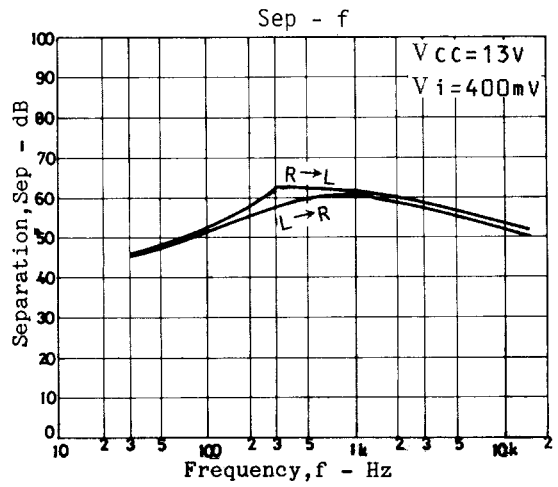
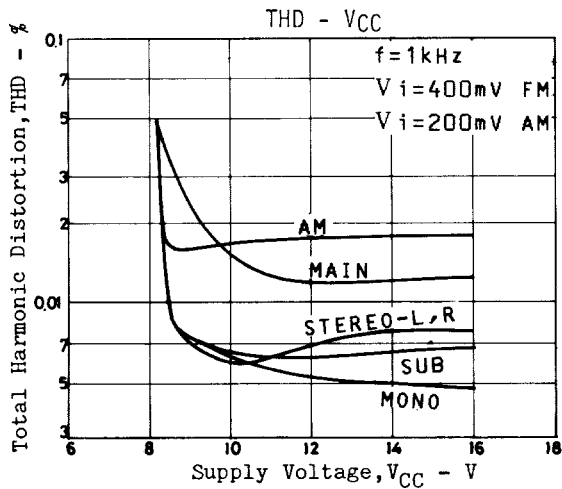
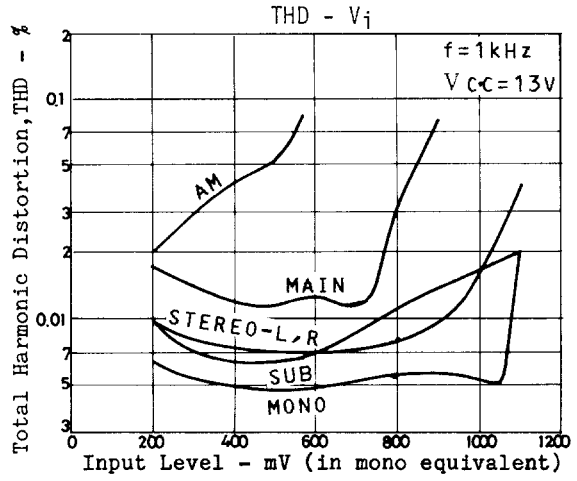
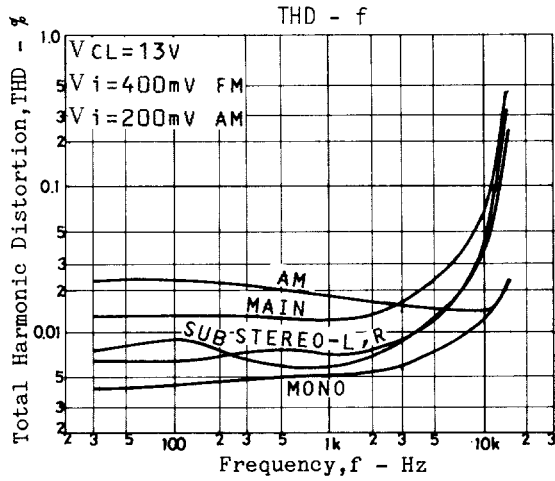

Fig. 6 f Response

Note : As the use of this low-pass filter makes the attenuation less at 19kHz, 38kHz, carrier leak at the LPF output causes the stereo distortion and separation characteristics to get worse than specified in the Electric Characteristics. For example, the stereo distortion becomes approximately 0.5% due to carrier leak.



LA3450



LA3450

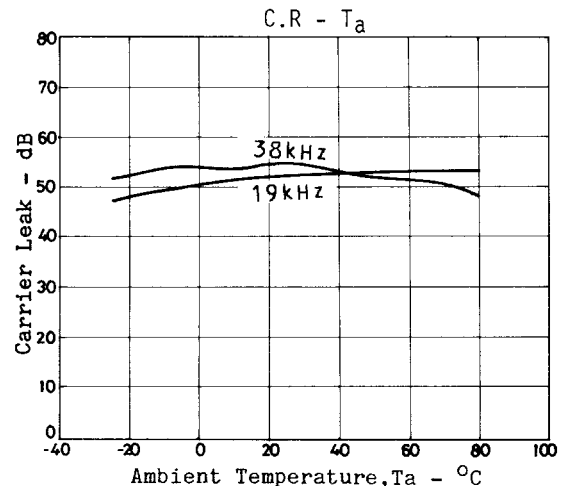
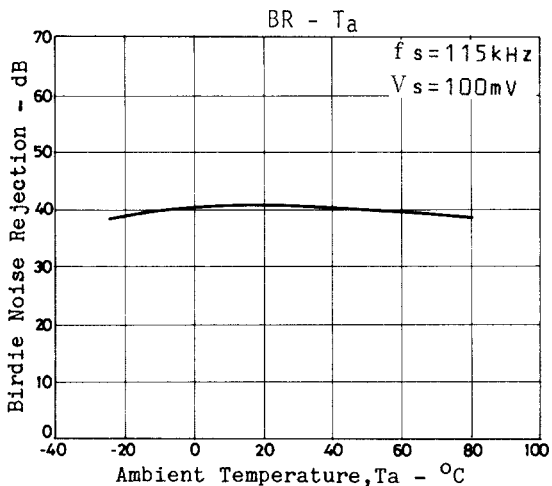
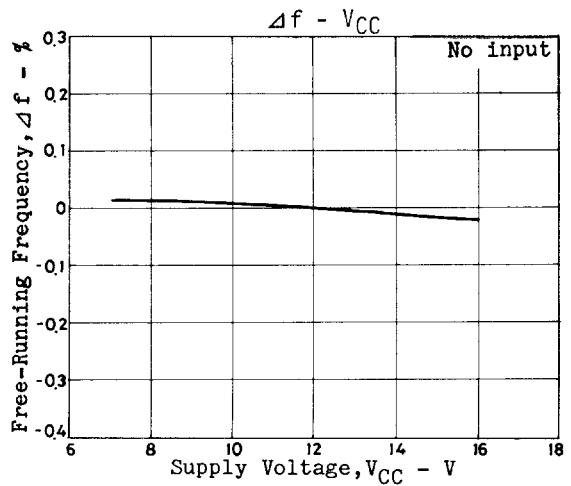
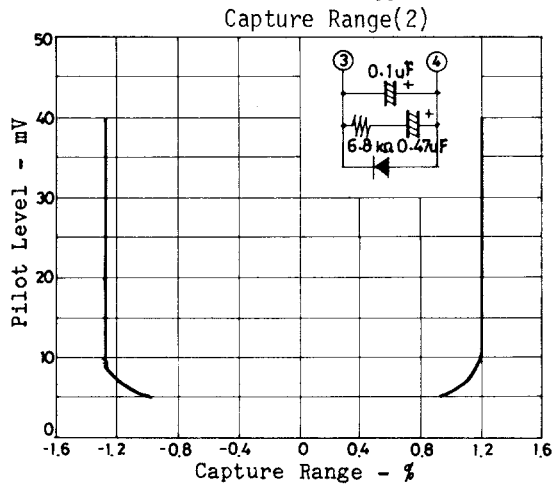
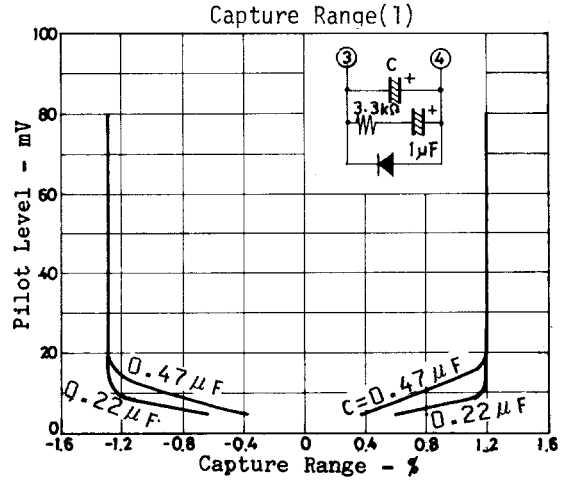
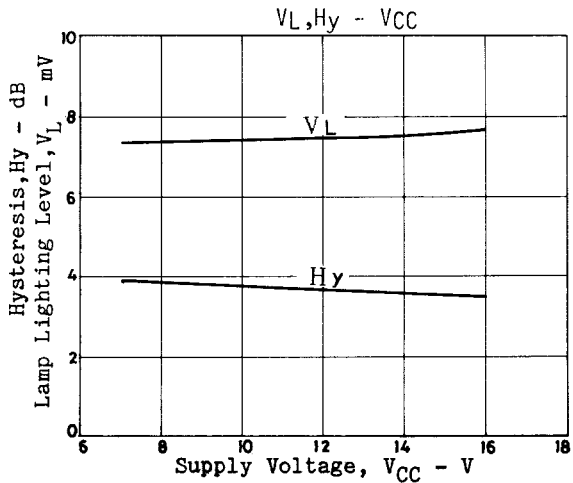
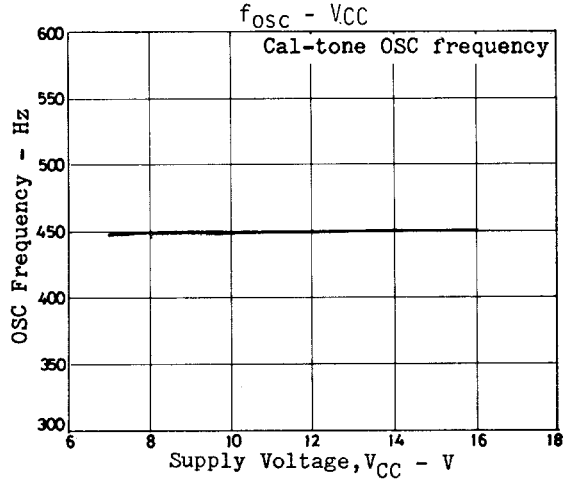
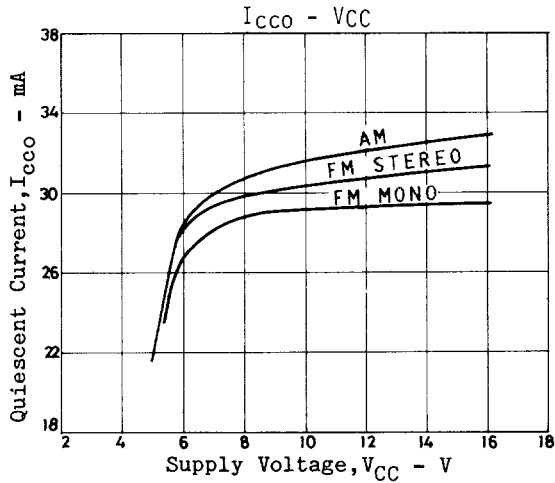

LA3450

AM/FM Changeover Voltage, VCO STOP Voltage - T_a

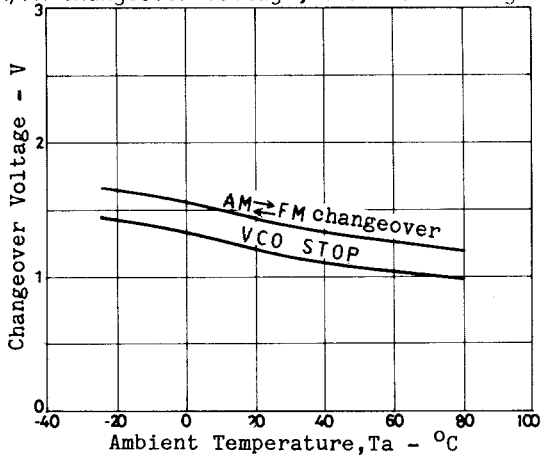

I_{cco} - T_a

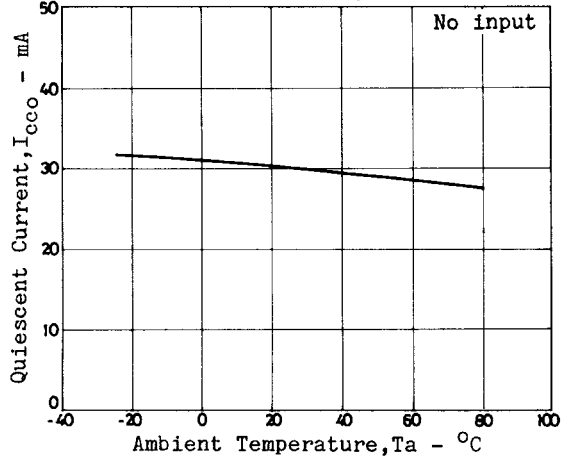

Carrier Frequency, f - T_a

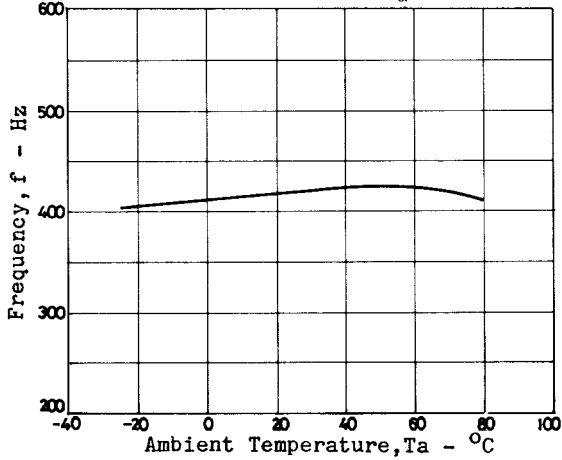

THD - T_a

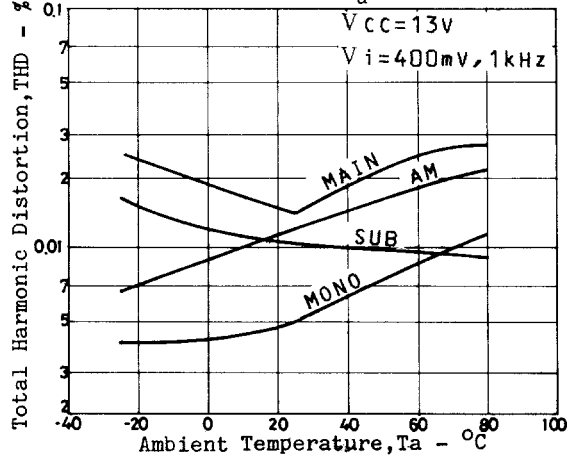

Sep - T_a

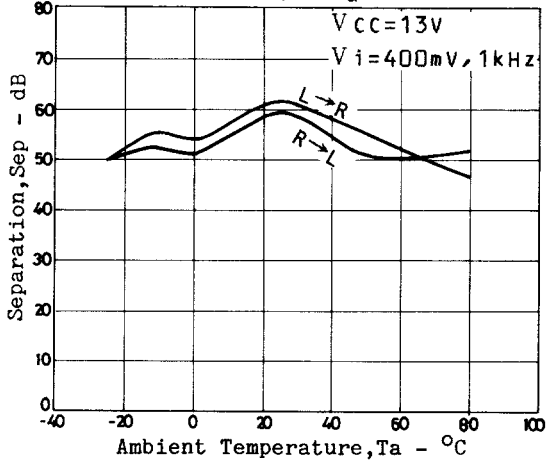

Crosstalk - T_a

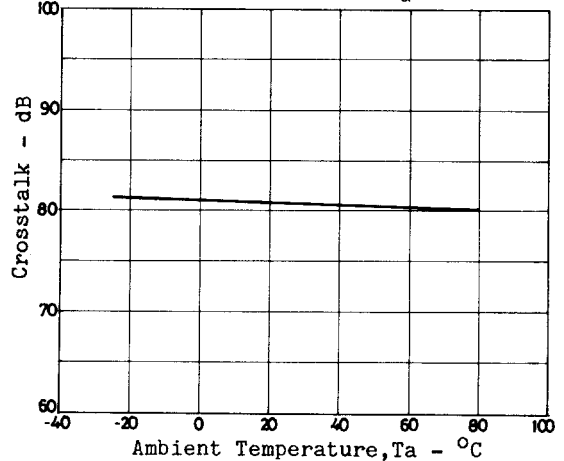

V_L - T_a

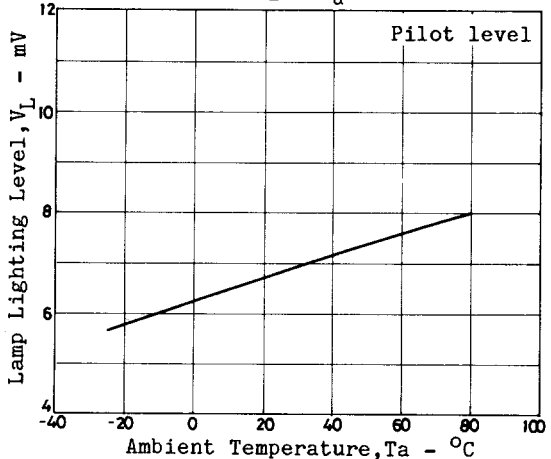

H_y - T_a

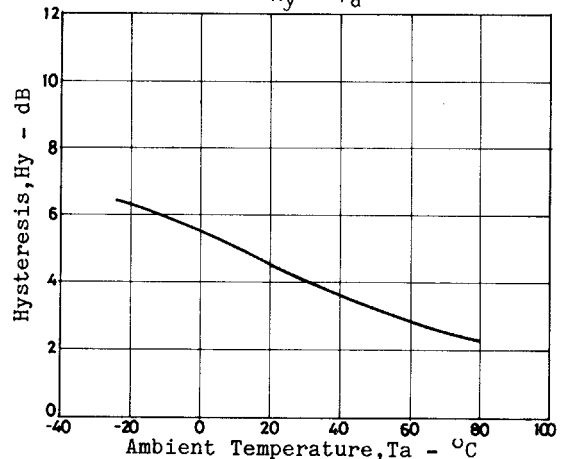

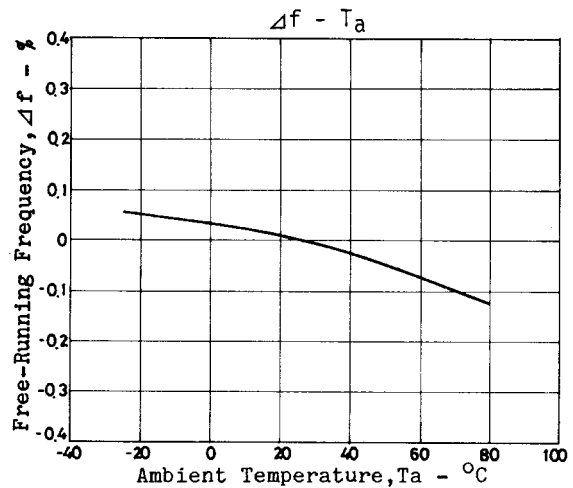
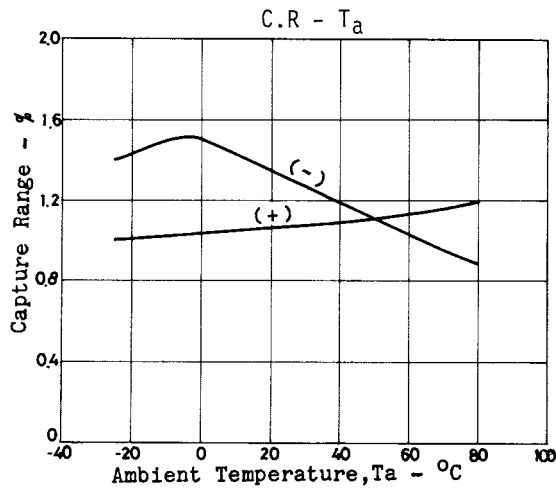

- Specifications of any and all SANYO products described or contained herein stipulate the performance, characteristics, and functions of the described products in the independent state, and are not guarantees of the performance, characteristics, and functions of the described products as mounted in the customer's products or equipment. To verify symptoms and states that cannot be evaluated in an independent device, the customer should always evaluate and test devices mounted in the customer's products or equipment.
- SANYO Electric Co., Ltd. strives to supply high-quality high-reliability products. However, any and all semiconductor products fail with some probability. It is possible that these probabilistic failures could give rise to accidents or events that could endanger human lives, that could give rise to smoke or fire, or that could cause damage to other property. When designing equipment, adopt safety measures so that these kinds of accidents or events cannot occur. Such measures include but are not limited to protective circuits and error prevention circuits for safe design, redundant design, and structural design.
- In the event that any or all SANYO products (including technical data, services) described or contained herein are controlled under any of applicable local export control laws and regulations, such products must not be exported without obtaining the export license from the authorities concerned in accordance with the above law.
- No part of this publication may be reproduced or transmitted in any form or by any means, electronic or mechanical, including photocopying and recording, or any information storage or retrieval system, or otherwise, without the prior written permission of SANYO Electric Co., Ltd.
- Any and all information described or contained herein are subject to change without notice due to product/technology improvement, etc. When designing equipment, refer to the "Delivery Specification" for the SANYO product that you intend to use.
- Information (including circuit diagrams and circuit parameters) herein is for example only; it is not guaranteed for volume production. SANYO believes information herein is accurate and reliable, but no guarantees are made or implied regarding its use or any infringements of intellectual property rights or other rights of third parties.

This catalog provides information as of February, 2000. Specifications and information herein are subject to change without notice.