

## Radial Lead Metal-Oxide Varistors for Low to Medium Voltage Operation

January 1998

### Features

- Recognized as "Protectors for Data Communications and Fire Alarm Circuits", UL File #E135010 to Std. 497B
- Wide Operating Voltage Range  $V_{M(AC)RMS}$  . . . 4V to 460V
- DC Voltage Ratings . . . . . 5.5V to 615V
- No Derating Up to 85°C Ambient
- 5 Model Sizes Available. . . . . 5, 7, 10, 14, and 20mm
- Radial-Lead Package for Hard-Wired or Printed Circuit Board Designs
- Available in Tape and Reel or Bulk Pack
- Standard Lead Form Options

### Description

The ZA Series of transient voltage surge suppressors are radial-lead varistors (MOVs) designed for use in the protection of low and medium-voltage circuits and systems. Typical applications include motor control, telecom, automotive systems, solenoid, and power supply circuits to protect circuit board components and maintain data integrity.

These devices are available in five model sizes: 5mm, 7mm, 10mm, 14mm and 20mm, and feature a wide  $V_{DC}$  voltage range of 5.5V to 615V.

See ZA Series Device Ratings and Specifications table for part number and brand information.

### Packaging

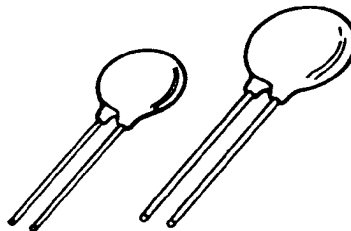

14mm, 20mm

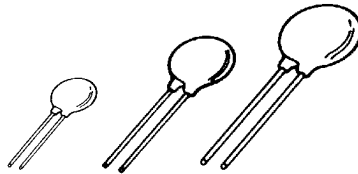

5mm, 7mm, 10mm

## ZA Series

**Absolute Maximum Ratings** For ratings of individual members of a series, see Device Ratings and Specifications chart

	ZA SERIES	UNITS
Continuous:		
Steady State Applied Voltage:		
AC Voltage Range ( $V_{M(AC)RMS}$ ) .....	4 to 460	V
DC Voltage Range ( $V_{M(DC)}$ ) .....	5.5 to 615	V
Transient:		
Peak Pulse Current ( $I_{TM}$ )		
For 8/20 $\mu$ s Current Wave (See Figure 2) .....	50 to 6500	A
Single Pulse Energy Range (Note 1)		
For 10/1000 $\mu$ s Current Wave ( $W_{TM}$ ) .....	0.1 to 52	J
Operating Ambient Temperature Range ( $T_A$ ) .....	-55 to 85	$^{\circ}$ C
Storage Temperature Range ( $T_{STG}$ ) .....	-55 to 125	$^{\circ}$ C
Temperature Coefficient ( $\alpha V$ ) of Clamping Voltage ( $V_C$ ) at Specified Test Current .....	<0.01	%/ $^{\circ}$ C
Hi-Pot Encapsulation (Isolation Voltage Capability) .....	2500	V
(Dielectric must withstand indicated DC voltage for one minute per MIL-STD 202, Method 301) .		
Insulation Resistance .....	1000	M $\Omega$

*CAUTION: Stresses above those listed in "Absolute Maximum Ratings" may cause permanent damage to the device. This is a stress only rating and operation of the device at these or any other conditions above those indicated in the operational sections of this specification is not implied.*

### Device Ratings and Specifications (Note 1)

ZA Series Varistors are listed under UL File No. E135010 as a UL recognized component.

PART NUMBER	MODEL SIZE DISC DIA. (mm)	BRAND	MAXIMUM RATING (85 $^{\circ}$ C)				SPECIFICATIONS (25 $^{\circ}$ C)				
			CONTINUOUS		TRANSIENT		VARISTOR VOLT-AGE AT 1mA DC TEST CURRENT		MAXIMUM CLAMPING VOLTAGE 8 x 20 $\mu$ s		TYPICAL CAPACITANCE f = 1MHz
			$V_{RMS}$	$V_{DC}$	ENERGY 10 x 1000 $\mu$ s	PEAK CURRENT 8 x 20 $\mu$ s					
			$V_{M(AC)}$	$V_{M(DC)}$	$W_{TM}$	$I_{TM}$	$V_{NOM}$ MIN	$V_{NOM}$ MAX	$V_C$	$I_{PK}$	C
			(V)	(V)	(J)	(A)	(V)		(V)	(A)	(pF)
V8ZA05	5	Z08	4	5.5	0.1	50	6	11	30	1	1400
V8ZA1	7	08Z1	4	5.5	0.4	100	6	11	22	2.5	3000
V8ZA2	10	08Z2	4	5.5	0.8	250	6	11	20	5	7500
V12ZA05	5	Z12	6	8	0.14	50	9	16	37	1	1200
V12ZA1	7	12Z1	6	8	0.6	100	9	16	34	2.5	2500
V12ZA2	10	12Z2	6	8	1.2	250	9	16	30	5	6000
V18ZA05	5	Z18	10	14	0.17	100	14.4	21.6	36	1	1000
V18ZA1	7	18Z1	10	14	0.8	250	14.4	21.6	36	2.5	2000
V18ZA2	10	18Z2	10	14	1.5	500	14.4	21.6	36	5	5000
V18ZA3	14	18Z3	10	14	3.5	1000	14.4	21.6	36	10	11000
V18ZA40	20	18Z40	10	14	80 (Note 2)	2000	14.4 (Note 3)	21.6	37	20	22000
V22ZA05	5	Z22	14	18	0.2	100	18.7	26	43	1	800
V22ZA1	7	22Z1	14	18	0.9	250	18.7	26	43	2.5	1600
V22ZA2	10	22Z2	14	18	2	500	18.7	26	43	5	4000
V22ZA3	14	22Z3	14	18	4	1000	18.7	26	43	10	9000
V24ZA50	20	24Z50	14	18 (Note 4)	100 (Note 2)	2000	19.2 (Note 3)	26	43	20	18000

## ZA Series

### Device Ratings and Specifications (Note 1) (Continued)

ZA Series Varistors are listed under UL File No. E135010 as a UL recognized component.

PART NUMBER	MODEL SIZE DISC DIA. (mm)	BRAND	MAXIMUM RATING (85°C)				SPECIFICATIONS (25°C)					
			CONTINUOUS		TRANSIENT		VARISTOR VOLT-AGE AT 1mA DC TEST CURRENT		MAXIMUM CLAMPING VOLTAGE 8 x 20µs		TYPICAL CAPACITANCE f = 1MHz	
			V <sub>RMS</sub>	V <sub>DC</sub>	ENERGY 10 x 1000µs	PEAK CURRENT 8 x 20µs						
			V <sub>M(AC)</sub>	V <sub>M(DC)</sub>	W <sub>TM</sub>	I <sub>TM</sub>	V <sub>NOM MIN</sub>	V <sub>NOM MAX</sub>	V <sub>C</sub>	I <sub>PK</sub>	C	
(V)	(V)	(J)	(A)	(V)		(V)	(A)	(pF)				
V27ZA05	5	Z27	17	22	0.25	100	23	31.1	53	1	600	
V27ZA1	7	27Z1	17	22	1	250	23	31.1	53	2.5	1300	
V27ZA2	10	27Z2	17	22	2.5	500	23	31.1	53	5	3000	
V27ZA4	14	27Z4	17	22	5	1000	23	31.1	53	10	7000	
V27ZA60	20	27Z60	17	22	120 (Note 2)	2000	23 (Note 3)	31.1	50	20	13000	
V33ZA05	5	Z33	20	26	0.3	100	29.5	38	65	1	500	
V33ZA1	7	33Z1	20	26	1.2	250	29.5	36.5	65	2.5	1100	
V33ZA2	10	33Z2	20	26	3	500	29.5	36.5	65	5	2700	
V33ZA5	14	33Z5	20	26	6	1000	29.5	36.5	65	10	6000	
V33ZA70	20	33Z70	21	27	150 (Note 2)	2000	29.5 (Note 3)	36.5	58	20	13000	
V36ZA80	20	36Z80	23	31	160 (Note 2)	2000	32 (Note 3)	40	63	20	12000	
V39ZA05	5	Z39	25	31	0.3	100	35	46	79	1	500	
V39ZA1	7	39Z1	25	31	1.2	250	35	43	79	2.5	1100	
V39ZA3	10	39Z3	25	31	3	500	35	43	76	5	2700	
V39ZA6	14	39Z6	25	31	6	1000	35	43	76	10	6000	
V39ZA20	20	39Z20	25	31	20	2000	35	43	76	20	12000	
V47ZA05	5	Z47	30	38	0.4	100	42	55	93	1	400	
V47ZA1	7	47Z1	30	38	1.8	250	42	52	93	2.5	800	
V47ZA3	10	47Z3	30	38	4.5	500	42	52	93	5	2000	
V47ZA7	14	47Z7	30	38	8.8	1000	42	52	93	10	4500	
V47ZA20	20	47Z20	30	38	23	2000	42	52	93	20	11000	
V56ZA05	5	Z56	35	45	0.5	100	50	66	110	1	360	
V56ZA2	7	56Z2	35	45	2.3	250	50	62	110	2.5	700	
V56ZA3	10	56Z3	35	45	5.5	500	50	62	110	5	1800	
V56ZA8	14	56Z8	35	45	10	1000	50	62	110	10	3900	
V56ZA20	20	56Z20	35	45	30	2000	50	62	110	20	10000	
V68ZA05	5	Z68	40	56	0.6	100	61	80	135	1	300	
V68ZA2	7	68Z2	40	56	3	250	61	75	135	2.5	600	
V68ZA3	10	68Z3	40	56	6.5	500	61	75	135	5	1500	
V68ZA10	14	68Z10	40	56	13	1000	61	75	135	10	3300	
V68ZA20	20	68Z20	40	56	33	2000	61	75	135	20	10000	
V82ZA05	5	Z82	50	68	2	400	73	97	135	5	240	
V82ZA2	7	82Z2	50	68	4	1200	73	91	135	10	500	
V82ZA4	10	82Z4	50	68	8	2500	73	91	135	25	1100	
V82ZA12	14	82Z12	50	68	15	4500	73	91	145	50	2500	

## ZA Series

### Device Ratings and Specifications (Note 1) (Continued)

ZA Series Varistors are listed under UL File No. E135010 as a UL recognized component.

PART NUMBER	MODEL SIZE DISC DIA. (mm)	BRAND	MAXIMUM RATING (85°C)				SPECIFICATIONS (25°C)					
			CONTINUOUS		TRANSIENT		VARISTOR VOLT-AGE AT 1mA DC TEST CURRENT		MAXIMUM CLAMPING VOLTAGE 8 x 20µs		TYPICAL CAPACITANCE f = 1MHz	
			V <sub>RMS</sub>	V <sub>DC</sub>	ENERGY 10 x 1000µs	PEAK CURRENT 8 x 20µs						
			V <sub>M(AC)</sub>	V <sub>M(DC)</sub>	W <sub>TM</sub>	I <sub>TM</sub>	V <sub>NOM MIN</sub>	V <sub>NOM MAX</sub>	V <sub>C</sub>	I <sub>PK</sub>	C	
(V)	(V)	(J)	(A)	(V)		(V)	(A)	(pF)				
V100ZA05	5	Z100	60	81	2.5	400	90	117	165	5	180	
V100ZA3	7	100Z	60	81	5	1200	90	110	165	10	400	
V100ZA4	10	100Z4	60	81	10	2500	90	110	165	25	900	
V100ZA15	14	100Z15	60	81	20	4500	90	110	175	50	2000	
V120ZA05	5	Z120	75	102	3	400	108	138	205	5	140	
V120ZA1	7	120Z	75	102	6	1200	108	132	205	10	300	
V120ZA4	10	120Z4	75	102	12	2500	108	132	200	25	750	
V120ZA6	14	120Z6	75	102	22	4500	108	132	210	50	1700	
V120ZA20	20	120Z20	75	102	33	6500	108	132	210	100	1500	
V150ZA05	5	Z150	92	127	4	400	135	173	250	5	120	
V150ZA1	7	Z051	95	127	8	1200	135	165	250	10	250	
V150ZA4	10	150Z4	95	127	15	2500	135	165	250	25	600	
V150ZA8	14	150Z8	95	127	20	4500	135	165	250	50	1400	
V150ZA20	20	150Z20	95	127	45	6500	135	165	250	100	1000	
V180ZA05	5	Z180	110	153	5	400	162	207	295	5	100	
V180ZA1	7	180Z	115	153	10	1200	162	198	300	10	200	
V180ZA5	10	180Z5	115	153	18	2500	162	198	300	25	500	
V180ZA10	14	180Z10	115	153	35	4500	162	198	300	50	1100	
V180ZA20	20	180Z20	115	153	52	6500	162	198	300	100	2400	
V205ZA05	5	Z205	130	170	5.5	400	184	226	340	5	100	
† V220ZA05	5	Z220	140	180	6	400	198	253	360	5	90	
V240ZA05	5	Z240	150	200	7	400	216	264	395	5	80	
† V270ZA05	5	Z270	175	225	7.5	400	243	311	455	5	70	
† V330ZA05	5	Z330	210	275	9	400	297	380	540	5	60	
V360ZA05	5	Z360	230	300	9.5	400	324	396	595	5	55	
† V390ZA05	5	Z390	250	330	10	400	351	449	650	5	50	
† V430ZA05	5	Z430	275	369	11	400	387	495	710	5	45	
V470ZA05	5	Z470	300	385	12	400	420	517	775	5	35	
V620ZA05	5	Z620	385	505	13	400	558	682	1025	5	33	
† V680ZA05	5	Z680	420	560	14	400	610	748	1120	5	32	
V715ZA05	5	Z715	440	585	15.5	400	643	787	1180	5	31	
V750ZA05	5	Z750	460	615	17	400	675	825	1240	5	30	

**NOTES:**

1. Average power dissipation of transients not to exceed 0.2W, 0.25W, 0.4W, 0.6W or 1W for model sizes 5mm, 7mm, 10mm, 14mm and 20mm, respectively.
2. Energy rating for impulse duration of 30ms minimum to one half of peak current (auto load dump).
3. 10mA DC test current.
4. Also rated to withstand 24V for 5 minutes.
5. Higher voltages available, contact Harris Semiconductor Power Marketing.

† Also listed to UL1449 "Transient Voltage Surge Suppressors" File #E75961.

**Power Dissipation Ratings**

Continuous power dissipation capability is not an applicable design parameter for a suppressor. When transients occur in rapid succession, the average power dissipation required is simply the energy (watt-seconds) per pulse times the number of pulses per second. The power so developed must be within the specifications shown on the Device Ratings and Specifications table for the specific device. Furthermore, the operating values need to be derated at high temperatures as shown in Figure 1. Because varistors can only dissipate a relatively small amount of average power they are, therefore, not suitable for repetitive applications that involve substantial amounts of average power dissipation.

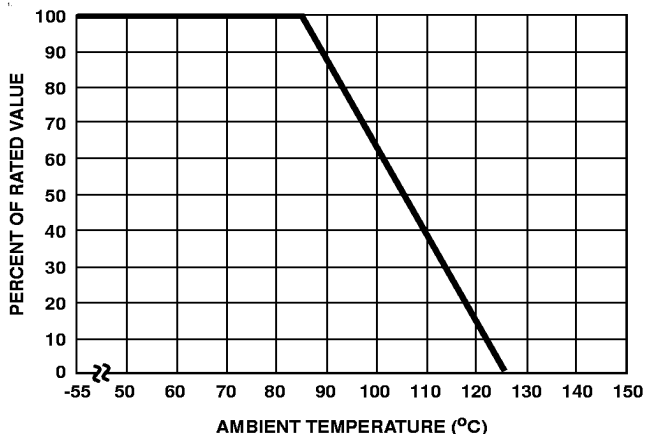

FIGURE 1. CURRENT, ENERGY AND POWER DERATING CURVE

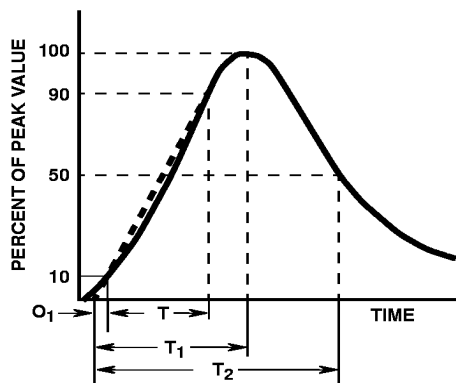

FIGURE 2. PEAK PULSE CURRENT TEST WAVEFORM

$O_1$  = Virtual Origin of Wave  
 $T$  = Time From 10% to 90% of Peak  
 $T_1$  = Virtual Front time =  $1.25 \cdot t$   
 $T_2$  = Virtual Time to Half Value (Impulse Duration)  
 Example: For an  $8/20\mu s$  Current Waveform:  
 $8\mu s = T_1 =$  Virtual Front Time  
 $20\mu s = T_2 =$  Virtual Time to Half Value

**Transient V-I Characteristics Curves**

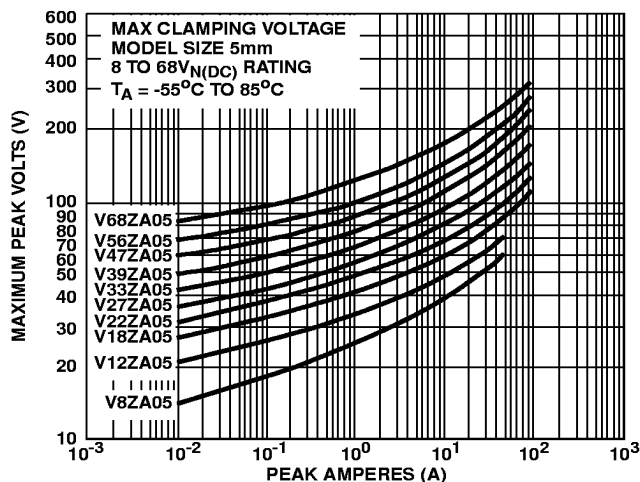

FIGURE 3. CLAMPING VOLTAGE FOR V8ZA05 - V68ZA05

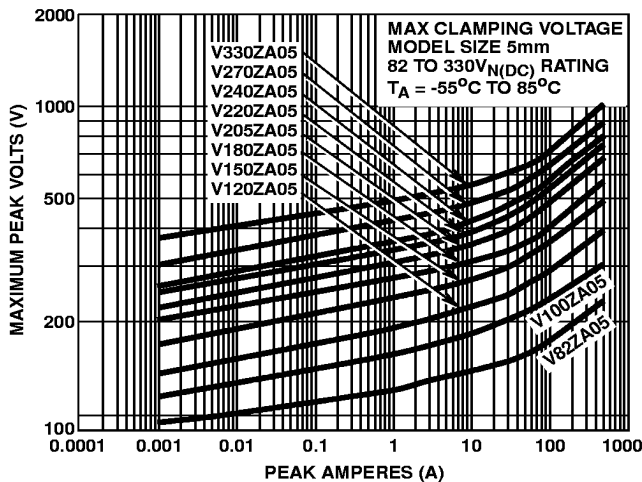

FIGURE 4. CLAMPING VOLTAGE FOR V82ZA05 - V330ZA05

Transient V-I Characteristics Curves (Continued)

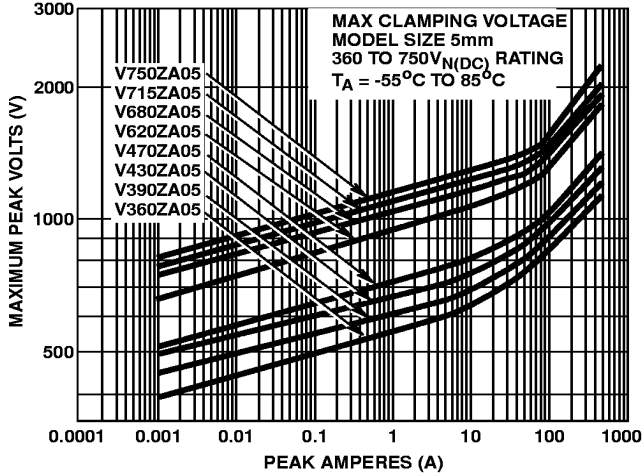

FIGURE 5. CLAMPING VOLTAGE FOR V360ZA05 - V750ZA05

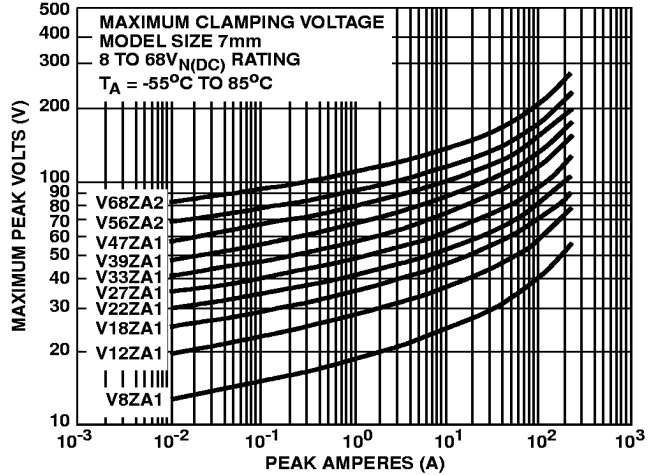

FIGURE 6. CLAMPING VOLTAGE FOR V8ZA1 - V68ZA2

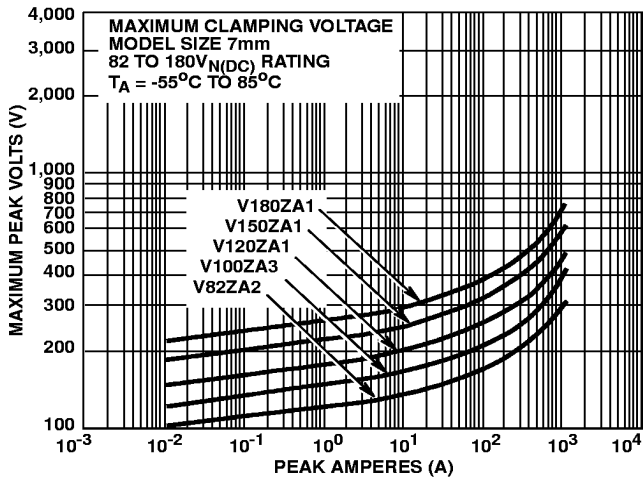

FIGURE 7. CLAMPING VOLTAGE FOR V82ZA2 - V180ZA1

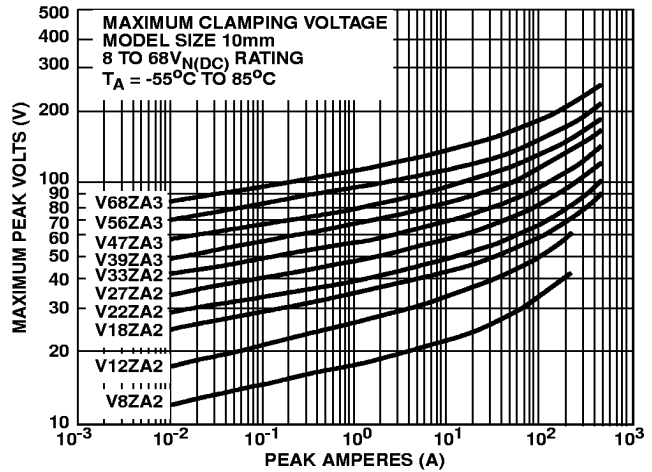

FIGURE 8. CLAMPING VOLTAGE FOR V8ZA2 - V68ZA3

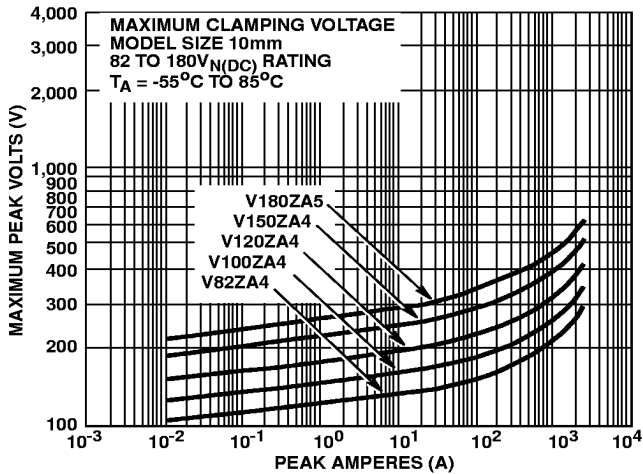

FIGURE 9. CLAMPING VOLTAGE FOR V82ZA4 - V180ZA5

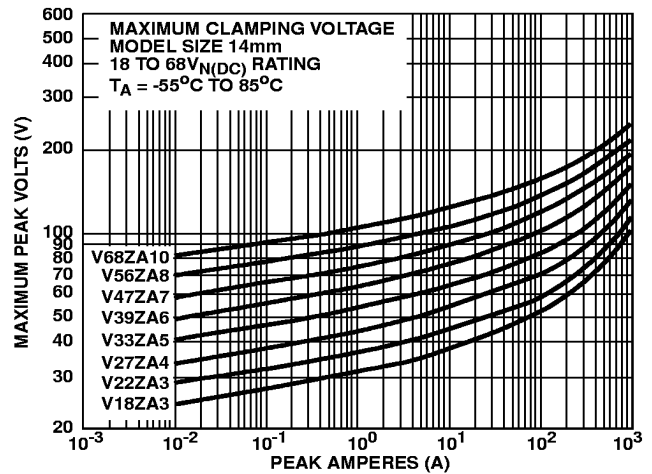

FIGURE 10. CLAMPING VOLTAGE FOR V18ZA3 - V68ZA10

# ZA Series

## Transient V-I Characteristics Curves (Continued)

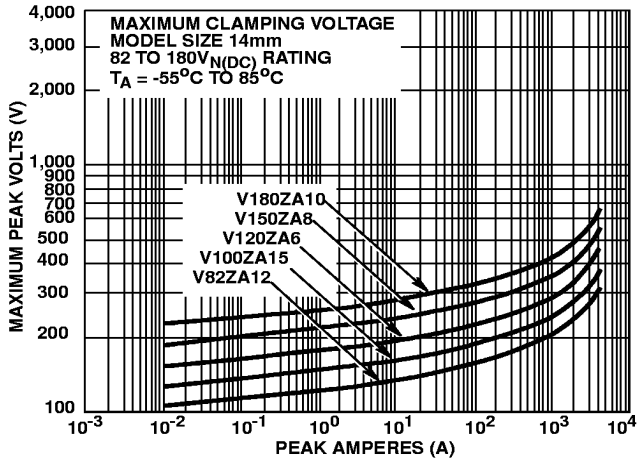

FIGURE 11. CLAMPING VOLTAGE FOR V82ZA12 - V180ZA10

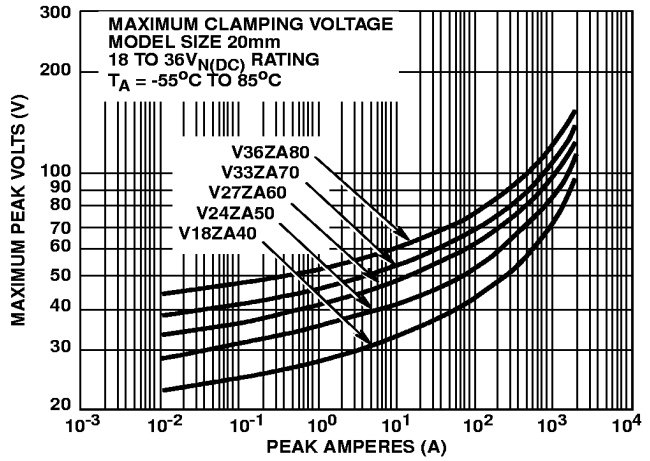

FIGURE 12. CLAMPING VOLTAGE FOR V18ZA40 - V36ZA80

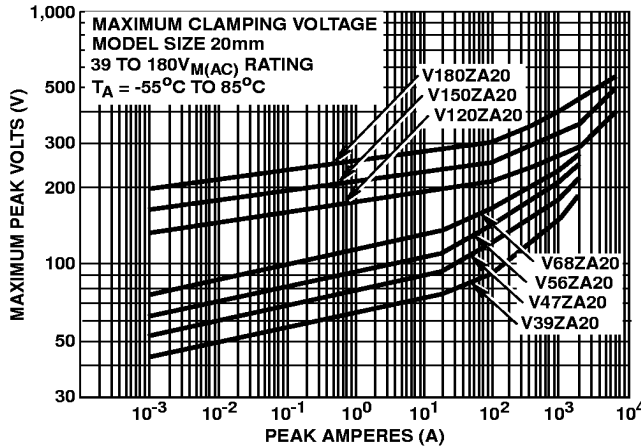

FIGURE 13. CLAMPING VOLTAGE FOR V39ZA20 - V180ZA20

## Pulse Rating Curves

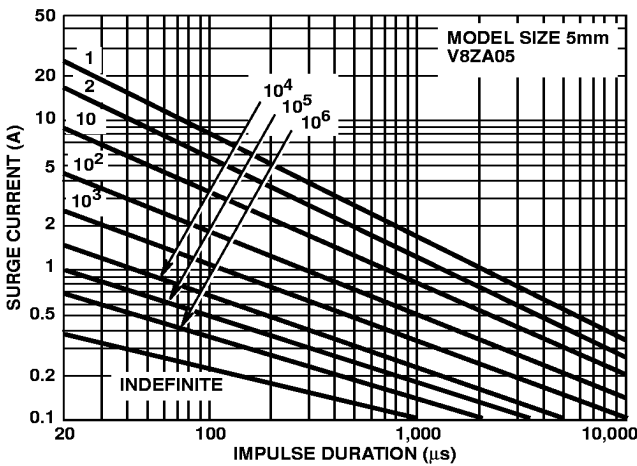

FIGURE 14. SURGE CURRENT RATING CURVES FOR V8ZA05

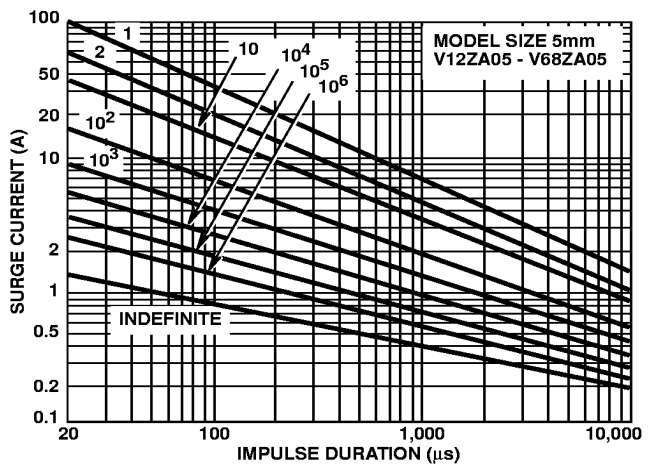

FIGURE 15. SURGE CURRENT RATING CURVES FOR V12ZA05 - V68ZA05

# ZA Series

## Pulse Rating Curves (Continued)

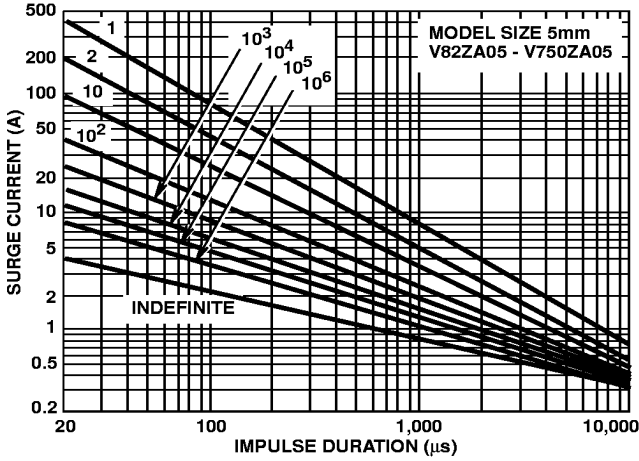

FIGURE 16. SURGE CURRENT RATING CURVES FOR V82ZA05 - V750ZA05

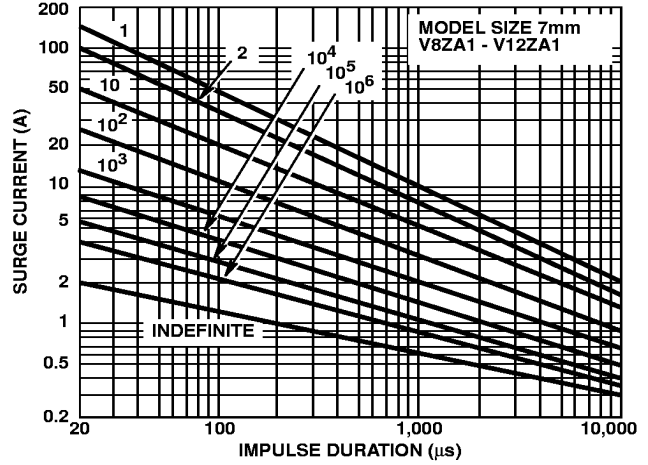

FIGURE 17. SURGE CURRENT RATING CURVES FOR V8ZA1 - V12ZA1

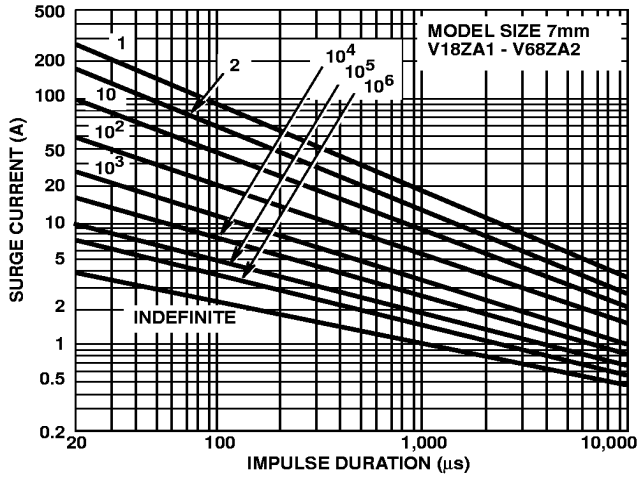

FIGURE 18. SURGE CURRENT RATING CURVES FOR V18ZA1 - V68ZA2

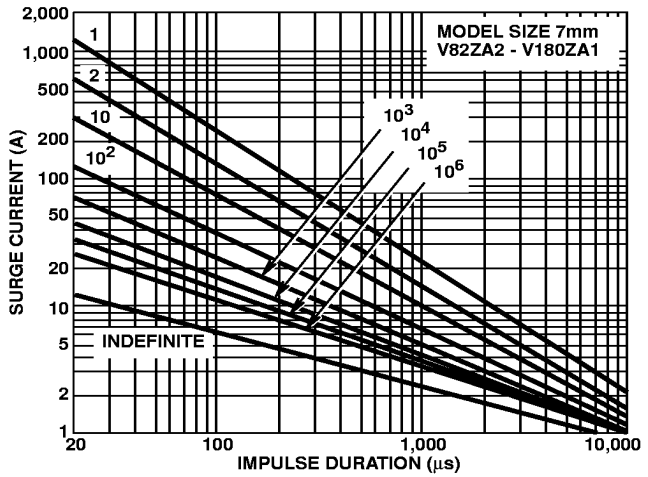

FIGURE 19. SURGE CURRENT RATING CURVES FOR V82ZA2 - V180ZA1

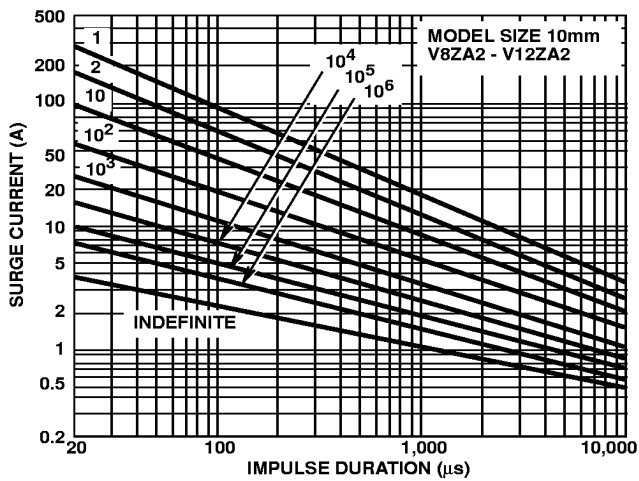

FIGURE 20. SURGE CURRENT RATING CURVES FOR V8ZA2 - V127ZA2

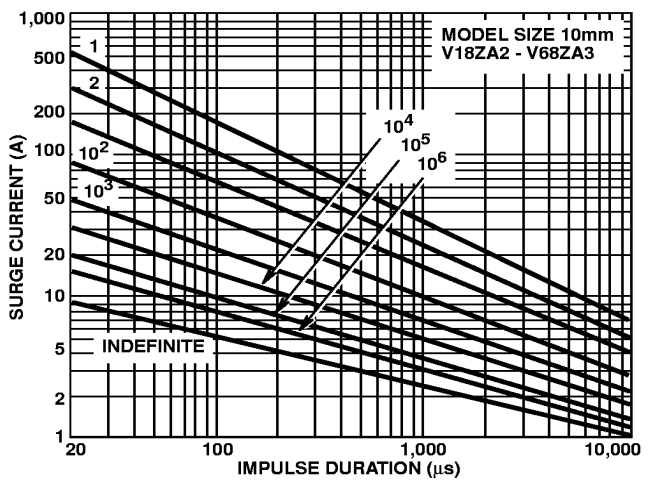

FIGURE 21. SURGE CURRENT RATING CURVES FOR V18ZA2 - V68ZA3



# ZA Series

## Pulse Rating Curves (Continued)

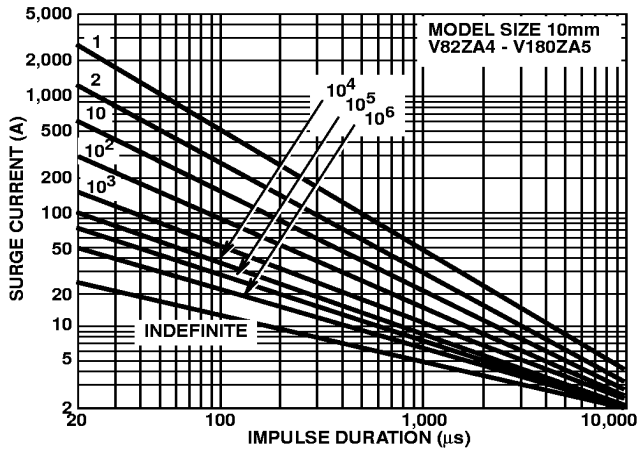

FIGURE 22. SURGE CURRENT RATING CURVES FOR V82ZA4 - V180ZA5

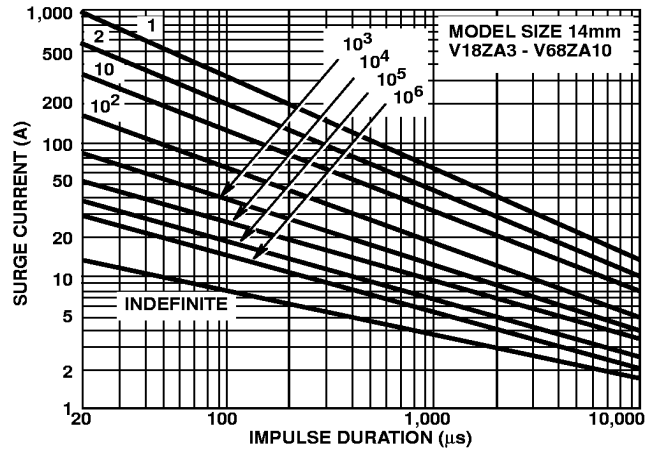

FIGURE 23. SURGE CURRENT RATING CURVES FOR V18ZA3 - V68ZA10

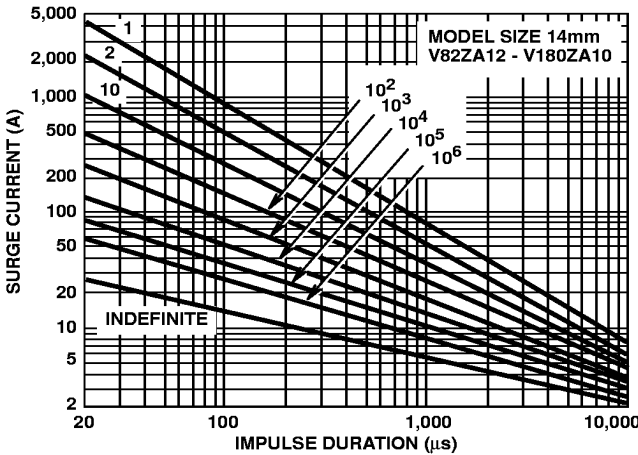

FIGURE 24. SURGE CURRENT RATING CURVES FOR V82ZA12 - V180ZA10

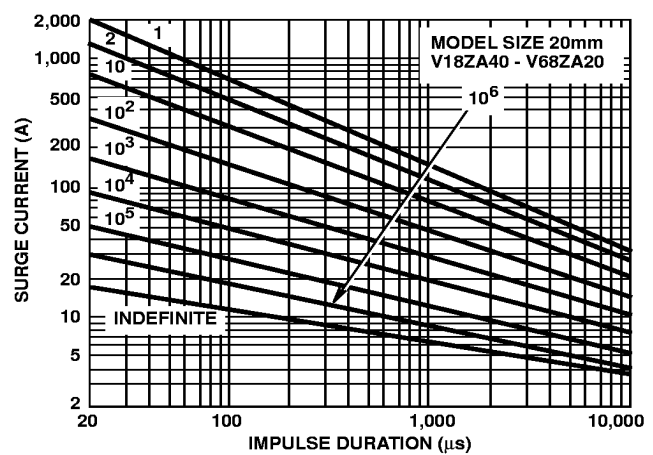

FIGURE 25. SURGE CURRENT RATING CURVES FOR V18ZA40 - V68ZA20

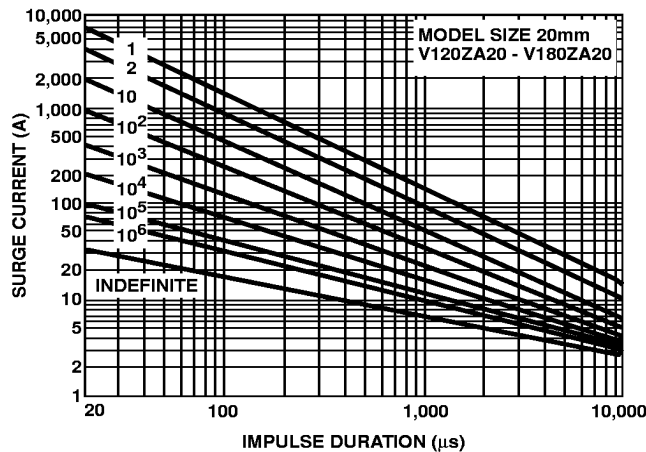
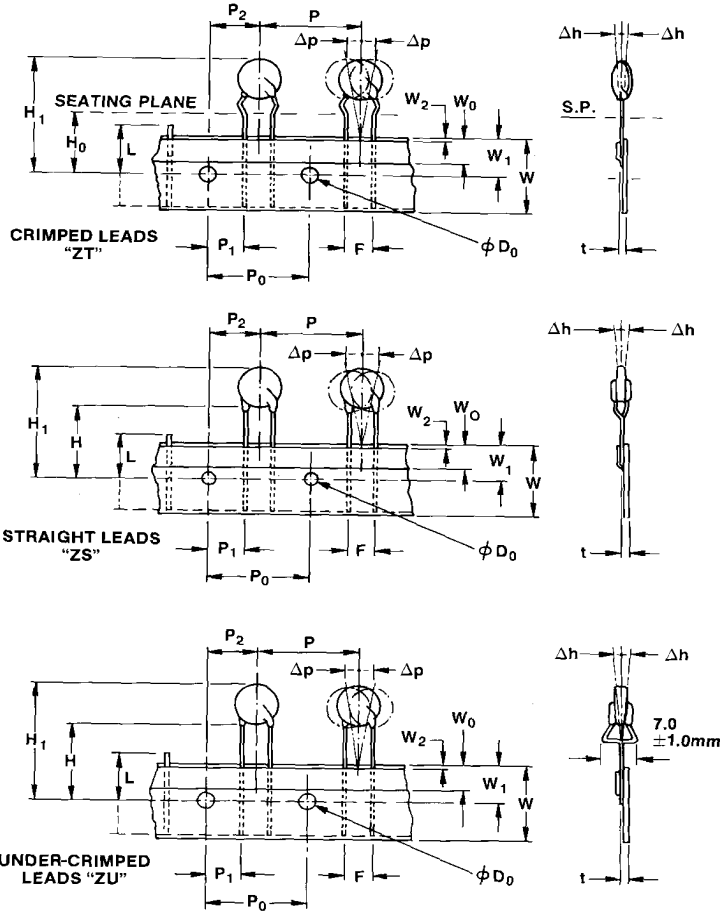

FIGURE 26. SURGE CURRENT RATING CURVES FOR V120ZA20 - V180ZA20

NOTE: If pulse ratings are exceeded, a shift of  $V_{N(DC)}$  (at specified current) of more than  $\pm 10\%$  could result. This type of shift, which normally results in a decrease of  $V_{N(DC)}$ , may result in the device not meeting the original published specifications, but it does not prevent the device from continuing to function, and to provide ample protection.

**Tape and Reel Specifications**

**Tape and Reel Data**



- Conforms to ANSI and EIA specifications
- Can be supplied to IEC Publication 286-2
- Radial devices on tape are supplied with crimped leads, straight leads, or under-crimped leads

SYMBOL	PARAMETER	MODEL SIZE				
		5mm	7mm	10mm	14mm	20mm
P	Pitch of Component	12.7 ± 1.0	12.7 ± 1.0	25.4 ± 1.0	25.4 ± 1.0	25.4 ± 1.0
P <sub>0</sub>	Feed Hole Pitch	12.7 ± 0.2	12.7 ± 0.2	12.7 ± 0.2	12.7 ± 0.2	12.7 ± 0.2
P <sub>1</sub>	Feed Hole Center to Pitch	3.85 ± 0.7	3.85 ± 0.7	2.6 ± 0.7	2.6 ± 0.7	2.6 ± 0.7
P <sub>2</sub>	Hole Center to Component Center	6.35 ± 1.0	6.35 ± 1.0	6.35 ± 1.0	6.35 ± 1.0	6.35 ± 1.0
F	Lead to Lead Distance	5.0 ± 1.0	5.0 ± 1.0	7.5 ± 1.0	7.5 ± 1.0	7.5 ± 1.0
Δh	Component Alignment	2.0 Max	2.0 Max	2.0 Max	2.0 Max	2.0 Max
W	Tape Width	18.0 + 1.0 18.0 - 0.5	18.0 + 1.0 18.0 - 0.5	18.0 + 1.0 18.0 - 0.5	18.0 + 1.0 18.0 - 0.5	18.0 + 1.0 18.0 - 0.5
W <sub>0</sub>	Hold Down Tape Width	6.0 ± 0.3	6.0 ± 0.3	6.0 ± 0.3	6.0 ± 0.3	12.0 ± 0.3
W <sub>1</sub>	Hole Position	9.0 + 0.75 9.0 - 0.50	9.0 + 0.75 9.0 - 0.50	9.0 + 0.75 9.0 - 0.50	9.0 + 0.75 9.0 - 0.50	9.0 + 0.75 9.0 - 0.50
W <sub>2</sub>	Hold Down Tape Position	0.5 Max	0.5 Max	0.5 Max	0.5 Max	0.5 Max
H	Height from Tape Center to Component Base	18.0 + 2.0 18.0 - 0.0	18.0 + 2.0 18.0 - 0.0	18.0 + 2.0 18.0 - 0.0	18.0 + 2.0 18.0 - 0.0	18.0 + 2.0 18.0 - 0.0
H <sub>0</sub>	Seating Plane Height	16.0 ± 0.5	16.0 ± 0.5	16.0 ± 0.5	16.0 ± 0.5	16.0 ± 0.5
H <sub>1</sub>	Component Height	29.0 Max	32.0 Max	36.0 Max	40.0 Max	46.5 Max
D <sub>0</sub>	Feed Hole Diameter	4.0 ± 0.2	4.0 ± 0.2	4.0 ± 0.2	4.0 ± 0.2	4.0 ± 0.2
t	Total Tape Thickness	0.7 ± 0.2	0.7 ± 0.2	0.7 ± 0.2	0.7 ± 0.2	0.7 ± 0.2
L	Length of Clipped Lead	11.0 Max	11.0 Max	11.0 Max	11.0 Max	12.0 Max
Δp	Component Alignment	3° Max	3° Max	3° Max	3° Max	3° Max

NOTE: Dimensions are in mm.

## ZA Series

### Tape and Reel Ordering Information

Crimped leads are standard on ZA types supplied in tape and reel and are denoted by the model letter "T". Model letter "S" denotes straight leads and letter "U" denotes special under-crimped leads.

Example:

STANDARD MODEL	CRIMPED LEADS	STRAIGHT LEADS	UNDER-CRIMPED LEADS
V18ZA3	V18ZT3	V18ZS3	V18ZU3

### SHIPPING QUANTITY

SIZE	RMS (MAX) VOLTAGE	QUANTITY PER REEL		
		"T" REEL	"S" REEL	"U" REEL
5mm	All	1000	1000	1000
7mm	All	1000	1000	1000
10mm	All	1000	1000	1000
14mm	< 300V	500	500	500
14mm	≥ 300V	500	500	500
20mm	< 300V	500	500	500
20mm	≥ 300V	500	500	500

### Mechanical Dimensions

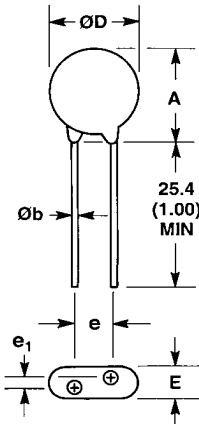

SYM-BOL	VOLTAGE MODEL	VARISTOR MODEL SIZE									
		5mm		7mm		10mm		14mm		20mm	
		MIN	MAX	MIN	MAX	MIN	MAX	MIN	MAX	MIN	MAX
A	All	-	10 (0.394)	-	12 (0.472)	-	16 (0.630)	-	20 (0.787)	-	26.5 (1.043)
ØD	All	-	7 (0.276)	-	9 (0.354)	-	12.5 (0.492)	-	17 (0.669)	-	23 (0.906)
e	All	4 (0.157)	6 (0.236)	4 (0.157)	6 (0.236)	6.5 (0.256)	8.5 (0.335)	6.5 (0.256)	8.5 (0.335)	6.5 (0.256) (Note 6)	8.5 (0.335) (Note 6)
e <sub>1</sub>	V8ZA-V56ZA	1 (0.039)	3 (0.118)	1 (0.039)	3 (0.118)	1 (0.039)	3 (0.118)	1 (0.039)	3 (0.118)	1 (0.039)	3 (0.118)
	V68ZA-V100ZA	1.5 (0.059)	3.5 (0.138)	1.5 (0.059)	3.5 (0.138)	1.5 (0.059)	3.5 (0.138)	1.5 (0.059)	3.5 (0.138)	NA (NA)	NA (NA)
	V120ZA-V180ZA	1 (0.039)	3 (0.118)	1 (0.039)	3 (0.118)	1 (0.039)	3 (0.118)	1 (0.038)	1 (0.118)	NA (NA)	NA (NA)
	V205ZA-V750ZA	1.5 (0.059)	3.5 (0.138)	-	-	-	-	-	-	-	-
E	V8ZA-V56ZA	-	5 (0.197)	-	5 (0.197)	-	5 (0.197)	-	5 (0.197)	-	5 (0.197)
	V68ZA-V100ZA	-	5.6 (0.220)	-	5.6 (0.220)	-	5.6 (0.220)	-	5.6 (0.220)	-	5.6 (0.220)
	V120ZA-V180ZA	-	5 (0.197)	-	5 (0.197)	-	5 (0.197)	-	5 (0.197)	-	5 (0.197)
	V205ZA-V750ZA	-	5.6 (0.220)	-	-	-	-	-	-	-	-
Øb	All	0.585 (0.023)	0.685 (0.027)	0.585 (0.023)	0.685 (0.027)	0.76 (0.030)	0.86 (0.034)	0.76 (0.030)	0.86 (0.034)	0.76 (0.030)	0.86 (0.034)

NOTES: Dimensions in millimeters, inches in parentheses.

6. 10mm ALSO AVAILABLE; See Additional Lead Style Options.

7. V24ZA50 only supplied with lead spacing of 6.35mm ± 0.5mm (0.25 ± 0.0196)  
Dimension E = 5.85 min.

## ZA Series

### Additional Lead Style Options

Radial lead types can be supplied with combination pre-formed crimp and trimmed leads. This option is supplied to the dimensions shown.

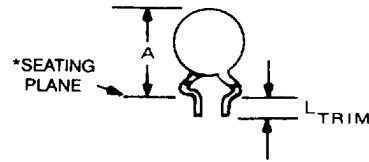

\*Seating plane interpretation per IEC-717

#### CRIMPED AND TRIMMED LEAD

SYMBOL	VARISTOR MODEL SIZE									
	5mm		7mm		10mm		14mm		20mm	
	MIN	MAX	MIN	MAX	MIN	MAX	MIN	MAX	MIN	MAX
A	-	13.0 (0.512)	-	15 (0.591)	-	19.5 (0.768)	-	22.5 (0.886)	-	29.0 (1.142)
L <sub>TRIM</sub>	2.41 (0.095)	4.69 (0.185)	2.41 (0.095)	4.69 (0.185)	2.41 (0.095)	4.69 (0.185)	2.41 (0.095)	4.69 (0.185)	2.41 (0.095)	4.69 (0.185)

NOTE: Dimensions in millimeters, inches in parentheses.

- To order this crimped and trimmed lead style, standard radial type model numbers are changed by replacing the model letter "ZA" with "ZC". This option is supplied in bulk only.
- For 10/±1mm lead spacing on 20mm diameter models only; append standard model numbers by adding "X10".

Example:

STANDARD CATALOG MODEL	ORDER AS:
V18ZA3	V18ZC3

Example:

STANDARD CATALOG MODEL	ORDER AS:
V18ZA40	V18ZA40X10

- For crimped leads without trimming and any variations to the above, contact Harris Semiconductor Power Marketing.

### Ordering Information

