

K5640 • K5641

These Photocouplers consist of two Gallium Arsenide Infrared Emitting Diodes and a Silicon NPN PhotoDarlington transistor in a 6-pin package.

FEATURES

- Collector-Emitter Voltage : Min.35V
- Current Transfer Ratio : Typ.500% (at $I_F=A1mA$, $V_{CE}=2V$)
- Electrical Isolation Voltage : AC5000Vrms
- Without Base Connection : K5640
- With Base Connection : K5641
- UL Recognized File No. E107486

APPLICATIONS

- Interface between two circuits of different potential
- Telephone Line Receiver
- Automatic Vending Machine
- Power Supply Regulators

DIMENSION

(Unit : mm)

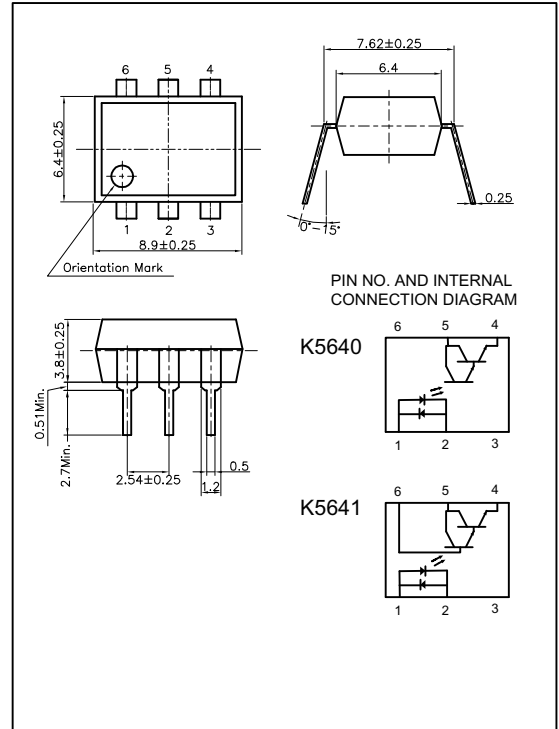

MAXIMUM RATINGS

($T_a=25$)

Parameter		Symbol	Rating	Unit
Input	Forward Current	I_F	± 60	mA
	Peak Forward Current ^{*1}	I_{FP}	± 1	A
	Power Dissipation	P_D	150	mW
	Junction Temperature	T_J	125	
Output	Collector-Emitter Breakdown Voltage	BV_{CEO}	35	V
	Emitter-Collector Breakdown Voltage	BV_{ECO}	6	V
	Collector-Base Breakdown Voltage**	BV_{CBO}	35	V
	Collector Current	I_C	50	mA
	Collector Power Dissipation	P_C	150	mW
Input to Output Isolation Voltage ^{*2}		V_{iso}	AC5000	V _{rms}
Storage Temperature		T_{stg}	-55~+125	
Operating Temperature		T_{opr}	-30~+100	
Lead Soldering Temperature ^{*3}		T_{sol}	260	
Total Power Dissipation		P_{tot}	200	mW

** Except for K5640

*1. Input current with 100ms pulse width, 1% duty cycle

*2. Measured at RH=40~60% for 1min

*3. 1/16 inch form case for 10sec

K5640 • K5641

ELECTRO-OPTICAL CHARACTERISTICS

(Ta=25 , unless otherwise noted)

Parameter		Symbol	Condition	Min.	Typ.	Max.	Unit.
Input	Forward Voltage	V _F	I _F = ±10mA	-	1.15	1.30	V
	Capacitance	C _T	V=0, f=1MHz	-	30	-	pF
Output	Collector-Emitter Breakdown Voltage	BV _{CEO}	I _C =1mA	35	-	-	V
	Emitter-Collector Breakdown Voltage	BV _{ECO}	I _E =0.1mA	6	-	-	V
	Collector-Base Breakdown Voltage **	BV _{CBO}	I _C =0.1mA	35	-	-	V
	Collector Dark Current	I _{CEO}	I _F =0, V _{CE} =10V	-	-	100	nA
	Capacitance	C _{CE}	V _{CE} =0, f=1MHz	-	10	-	pF
Coupled	Current Transfer Ratio *4	CTR	I _F = ±1mA, V _{CE} =2V	-	500	-	%
	Collector-Emitter Saturation Voltage	V _{CE(SAT)}	I _F = ±1mA, I _C =2mA	-	0.85	1.0	V
	Input-Output Capacitance	C _{IO}	V=0, f=1MHz	-	1	-	pF
	Input-Output Isolation Resistance	R _{IO}	RH=40~60%, V=500V	-	10 ¹¹	-	
	Rise Time	t _r	V _{CE} =10V, R _L =100	-	100	-	μs
	Fall Time	t _f	I _C =2mA	-	100	-	μs

** Except for K5640

*4. CTR=(I_C/I_F) X 100 (%)

K5640 • K5641

Forward Current vs. Ambient Temperature

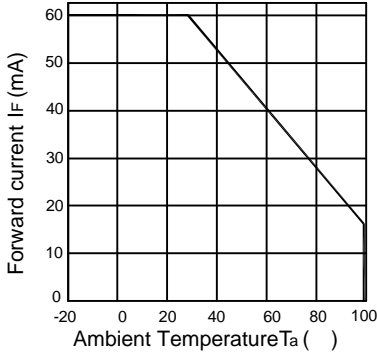

Collector Power Dissipation vs. Ambient Temperature

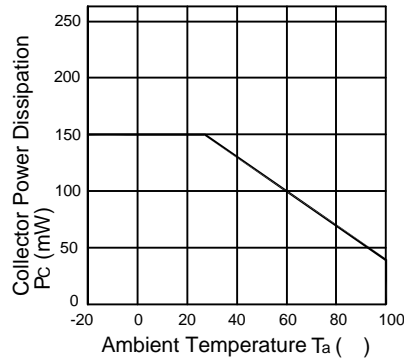

Forward Current vs. Forward Voltage

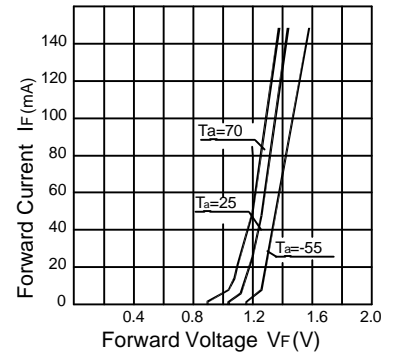

Collector Current vs. Collector-Emitter Voltage

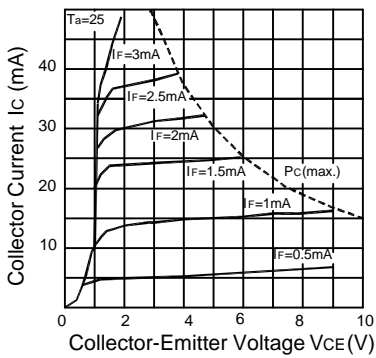

Dark Current vs. Ambient Temperature

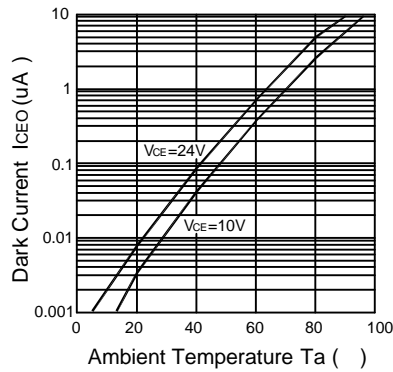

Collector Current vs. Forward Current

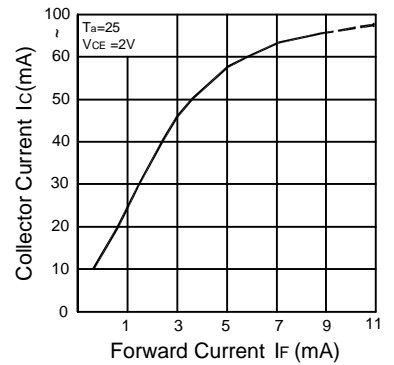

Switching Time Test Circuit

