

CPDF Series-HF (RoHS Device)

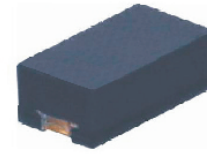

Features

- Halogen free.
- Bi-directional ESD protection.
(16kV) IEC 61000-4-2 rating.
- Surface mount package.
- High component density.

Mechanical data

- Case: 1005(2512) standard package, molded plastic.
- Terminals: Gold plated, solderable per MIL-STD-750, method 2026.
- Marking Code:
 - CPDF5V0-HF: E05
 - CPDF12V-HF: E12
 - CPDF24V-HF: E24
- Mounting position: Any.
- Weight: 0.006 gram (approx.).

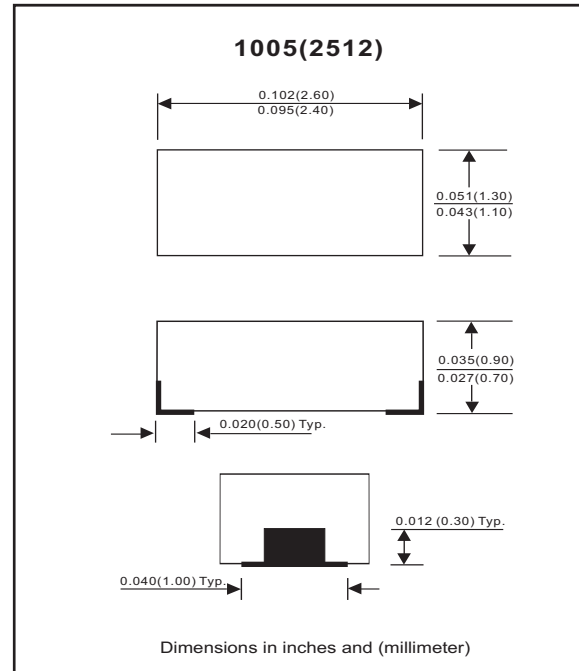

Electrical Characteristics (at TA=25°C unless otherwise noted)

Parameter	Conditions	Symbol	Min	Typ	Max	Unit
Diode breakdown voltage	CPDF5V0-HF CPDF12V-HF CPDF24V-HF I _R = 1mA	V _{BD}	5.1 13 25	7.0 17 28		V
Leakage current	CPDF5V0-HF CPDF12V-HF CPDF24V-HF V _R = 5V V _R = 12V V _R = 24V	I _L		0.1	2.0	uA
Junction capacitance	CPDF5V0-HF CPDF12V-HF CPDF24V-HF V _R = 0V, f = 1MHz	C _T		15 12 10	20 --- ---	pF
ESD capability	CPDF Series-HF IEC 61000-4-2(air) IEC 61000-4-2(contact)	ESD			16 8	kV
Clamping voltage	CPDF5V0-HF CPDF12V-HF CPDF24V-HF I _{PP} = 5A, T _P = 8/20us I _{PP} = 1A, T _P = 8/20us I _{PP} = 1A, T _P = 8/20us	V _C			15 25 47	V
Peak pulse power	CPDF5V0-HF CPDF12V-HF CPDF24V-HF T _P = 8/20us	P _{PP}			75 25 47	W
Operation temperature	CPDF Series-HF	T _j			125	°C
Storage temperature	CPDF Series-HF	T _{STG}	-55		150	°C

RATING AND CHARACTERISTIC CURVES (CPDF Series-HF)

Fig. 1 - 8/20us Peak pulse current wave form acc. IEC 61000-4-5

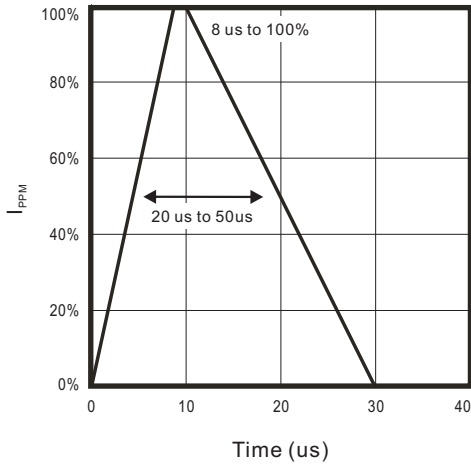

Fig. 2 - Reverse characteristics

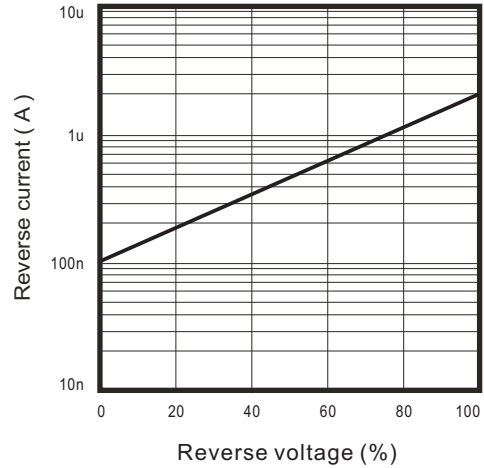

Fig. 3 - Capacitance between terminals characteristics

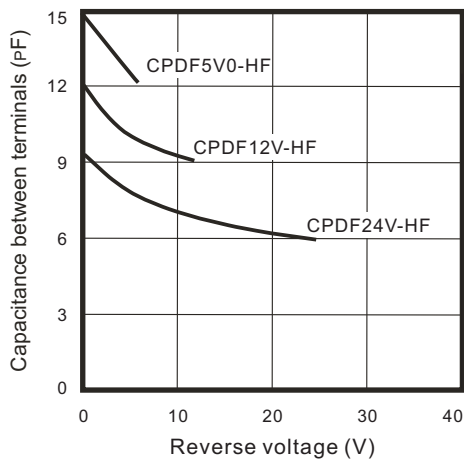
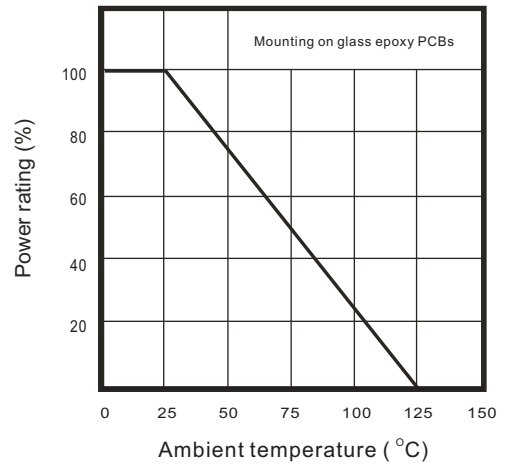
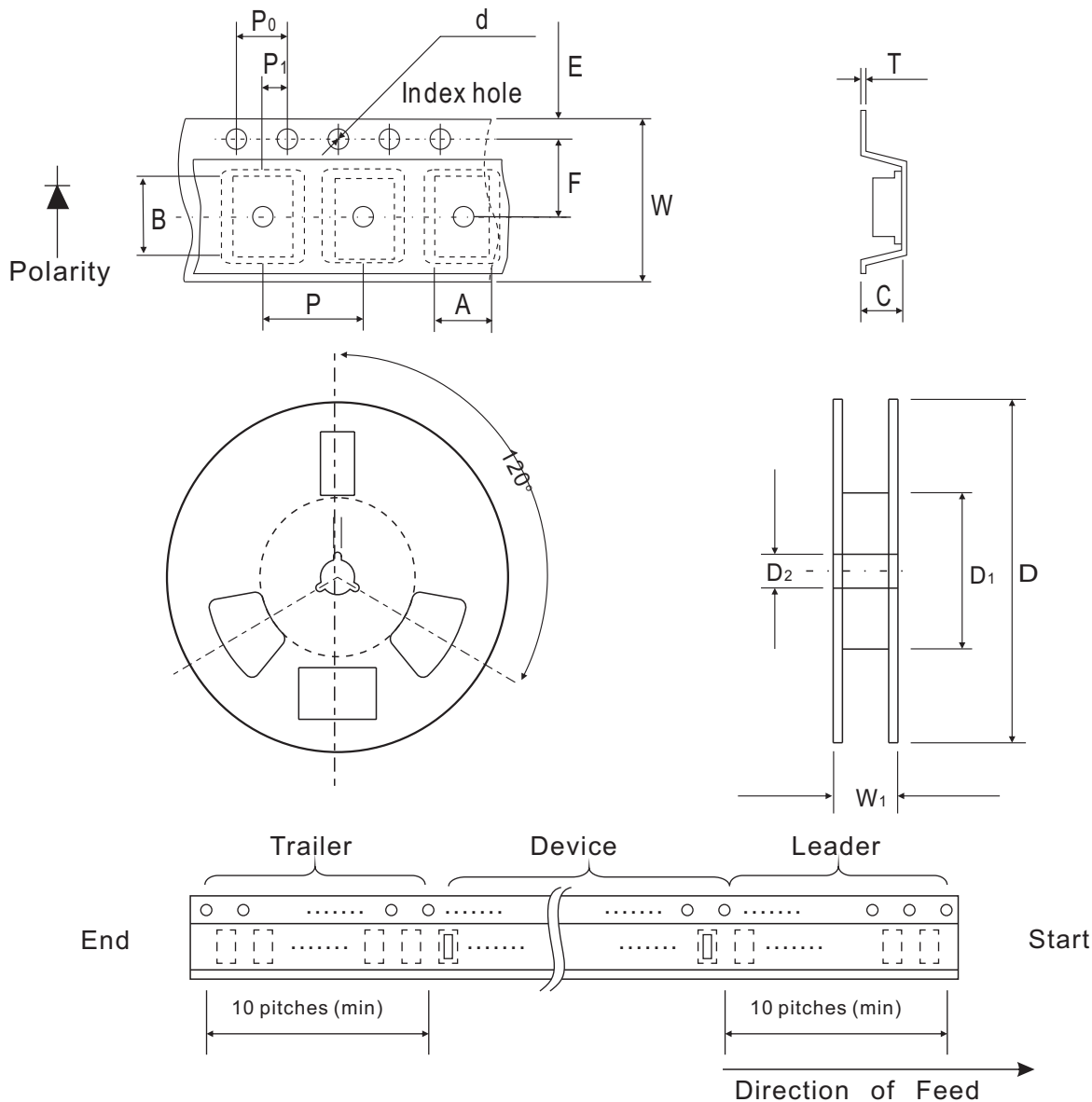

Fig. 4 - Power rating derating curve



Reel Taping Specification



F/1005	SYMBOL	A	B	C	d	D	D ₁	D ₂
	(mm)	1.55 ± 0.10	2.65 ± 0.10	1.05 ± 0.10	1.55 ± 0.05	178 ± 1	60.0 MIN.	13.0 ± 0.20
	(inch)	0.061 ± 0.004	0.104 ± 0.004	0.041 ± 0.004	0.061 ± 0.002	7.008 ± 0.04	2.362 MIN.	0.512 ± 0.008

F/1005	SYMBOL	E	F	P	P ₀	P ₁	T	W	W ₁
	(mm)	1.75 ± 0.10	3.50 ± 0.05	4.00 ± 0.10	4.00 ± 0.10	2.00 ± 0.05	0.23 ± 0.05	8.00 ± 0.20	13.5 MAX.
	(inch)	0.069 ± 0.004	0.138 ± 0.002	0.157 ± 0.004	0.157 ± 0.004	0.079 ± 0.004	0.009 ± 0.002	0.315 ± 0.008	0.531 MAX.

Marking Code

Part Number	Marking Code
CPDF5V0-HF	E05
CPDF12V-HF	E12
CPDF24V-HF	E24



xxx = Product type marking code

Suggested PAD Layout

SIZE	F/1005	
	(mm)	(inch)
A	2.10	0.083
B	1.20	0.047
C	1.20	0.047
D	3.30	0.130
E	0.90	0.035

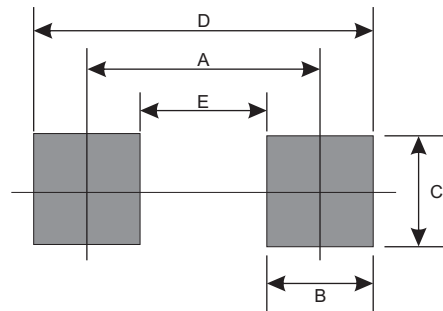

Standard Package

Case Type	Qty per Reel	Reel Size
	(Pcs)	(inch)
F/1005	4000	7