



88CXX

CMOS IC

BUILT-IN DELAY CIRCUIT HIGH-PRECISION VOLTAGE DETECTOR

DESCRIPTION

The UTC **88CXX** series are highly accurate, low power consumption voltage detector, manufactured using CMOS process. The detection voltage is fixed internally, with an accuracy of $\pm 2.0\%$. Besides, UTC **88CXX** can easily delay a release signal by attachment of an external capacitor with built-in delay circuit.

FEATURES

- * Highly accurate : 2.0%
- * Hysteresis characteristics: 5% typ.
- * Ultra-low current consumption: 1.0 μ A typ. ($V_{DD}=2.0V$)
- * Detection voltage ranges: 1.5~6V and step by 0.1V.
- * Low operating voltage based on detection voltage
- * Delay time setting by an additional external capacitor.

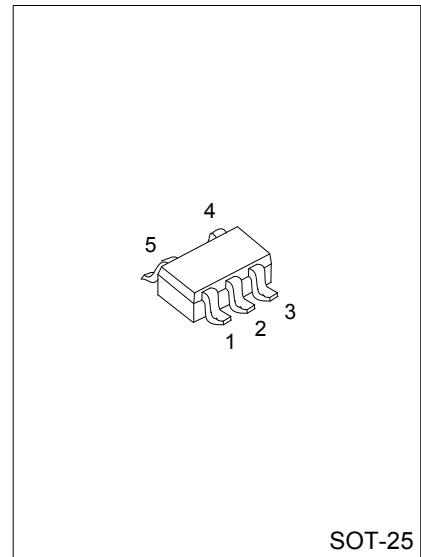

ORDERING INFORMATION

Ordering Number			Package	Packing
Normal	Lead Free	Halogen Free		
88CXX-AF5-R	88CXXL-AF5-R	88CXXG-AF5-R	SOT-25	Tape Reel

<p>88CXXL-AF5-R</p> <p>(1)Packing Type (2)Package Type (3)Lead Plating (4)Output Voltage Code</p>	<p>(1) R: Tape Reel (2) AF5: SOT-25 (3) G: Halogen Free, L: Lead Free, Blank: Pb/Sn (4) xx: refer to Marking Information</p>
---------------------------------------------------------------------------------------------------------------	------------------------------------------------------------------------------------------------------------------------------------------

MARKING INFORMATION

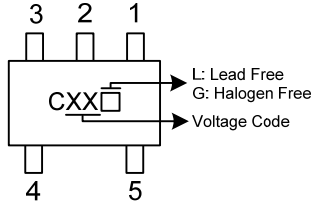
PACKAGE	VOLTAGE CODE			MARKING
SOT-25	15:1.5V	30:3.0V		
	16:1.6V	31:3.1V		
	17:1.7V	32:3.2V		
	18:1.8V	33:3.3V		
	19:1.9V	34:3.4V		
	20:2.0V	35:3.5V		
	21:2.1V	36:3.6V		
	22:2.2V	37:3.7V		
	23:2.3V	38:3.8V		
	24:2.4V	39:3.9V		
	25:2.5V	40:4.0V		
	26:2.6V	41:4.1V		
	27:2.7V	42:4.2V		
	28:2.8V	43:4.3V		
	29:2.9V	44:4.4V		
		45:4.5V		
		46:4.6V		
		47:4.7V		
		48:4.8V		
		49:4.9V		
		50:5.0V		
		51:5.1V		
		52:5.2V		
		53:5.3V		
		60:6.0V		

PIN CONFIGURATION

PIN NO.	PIN NAME
1	V_{OUT}
2	V_{DD}
3	V_{SS}
4	NC
5	C_D

■ BLOCK DIAGRAMS

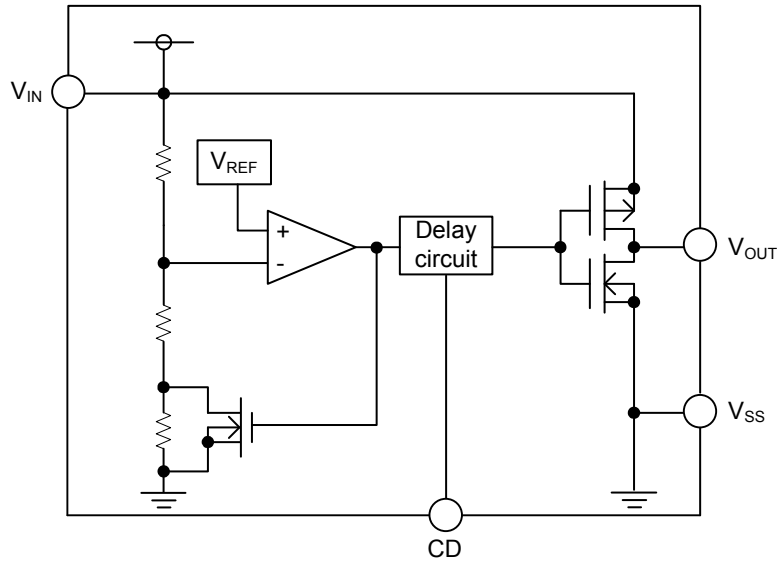

■ ABSOLUTE MAXIMUM RATINGS ($T_A=25^\circ\text{C}$, unless otherwise specified.)

PARAMETER	SYMBOL	RATINGS	UNIT
Power Supply Voltage	$V_{DD}-V_{SS}$	12	V
C_D Terminal Input Voltage	V_{CD}	$V_{SS}-0.3 \sim V_{DD}+0.3$	V
Output Voltage	V_{OUT}	$V_{SS}-0.3 \sim V_{DD}+0.3$	V
Output Current	I_{OUT}	50	mA
Power Dissipation	P_D	250	mW
Operating Temperature	T_{OPR}	-40 ~ +85	$^\circ\text{C}$
Storage Temperature	T_{STG}	-40 ~ +150	$^\circ\text{C}$

Note: Absolute maximum ratings are those values beyond which the device could be permanently damaged.

Absolute maximum ratings are stress ratings only and functional device operation is not implied.

■ ELECTRICAL CHARACTERISTICS ($T_A=25^\circ\text{C}$, unless otherwise specified.)

Detection voltage (1.5V ~ 2.6V)

PARAMETER	SYMBOL	TEST CONDITONS	MIN	TYP	MAX	UNIT
Detect Voltage	V_{DET}		$-V_{DET} \times 0.98$	$-V_{DET}$	$-V_{DET} \times 1.02$	V
Hysteresis Range	V_{HYS}		$-V_{DET} \times 0.03$	$-V_{DET} \times 0.05$	$-V_{DET} \times 0.08$	V
Supply Current	I_{SS}	$V_{DD}=3.5V$		1.2	5.0	μA
Operating Voltage	V_{DD}		0.95		10.0	V
Output Current	I_{OUT}	Nch $V_{DS}=0.5V$	$V_{DD}=1.20V$	0.23	0.50	mA
		Pch $V_{DS}=0.5V$	$V_{DD}=4.8V$	0.36	0.62	mA
Detect Voltage Temperature Characteristics	$\frac{\Delta V_{DET}}{\Delta T_{OPR} \times V_{DET}}$			± 100		ppm/ $^\circ\text{C}$
Delay Time	t_{DLY}	$V_{DD}=3.5V, C_D=4.7nF$	23	30	37	ms

Detection voltage (2.7V ~ 3.9V)

PARAMETER	SYMBOL	TEST CONDITONS	MIN	TYP	MAX	UNIT
Detect Voltage	V_{DET}		$-V_{DET} \times 0.98$	$-V_{DET}$	$-V_{DET} \times 1.02$	V
Hysteresis Range	V_{HYS}		$-V_{DET} \times 0.03$	$-V_{DET} \times 0.05$	$-V_{DET} \times 0.08$	V
Supply Current	I_{SS}	$V_{DD}=4.5V$		1.3	5.0	μA
Operating Voltage	V_{DD}		0.95		10.0	V
Output Current	I_{OUT}	Nch $V_{DS}=0.5V$	$V_{DD}=1.20V$	0.23	0.50	mA
			$V_{DD}=2.40V$	1.60	3.70	mA
		Pch $V_{DS}=0.5V$	$V_{DD}=4.8V$	0.36	0.62	mA
Detect Voltage Temperature Characteristics	$\frac{\Delta V_{DET}}{\Delta T_{OPR} \times V_{DET}}$			± 100		ppm/ $^\circ\text{C}$
Delay Time	t_{DLY}	$V_{DD}=4.5V, C_D=4.7nF$	20	28	34	ms

■ ELECTRICAL CHARACTERISTICS(Cont.)

Detection voltage (4.0V ~ 5.4V)

PARAMETER	SYMBOL	TEST CONDITONS	MIN	TYP	MAX	UNIT	
Detect Voltage	V_{DET}		$-V_{DET}$ $\times 0.98$	$-V_{DET}$	$-V_{DET}$ $\times 1.02$	V	
Hysteresis Range	V_{HYS}		$-V_{DET}$ $\times 0.03$	$-V_{DET}$ $\times 0.05$	$-V_{DET}$ $\times 0.08$	V	
Supply Current	I_{SS}	$V_{DD}=6.0V$		1.5	5.0	μA	
Operating Voltage	V_{DD}		0.95		10.0	V	
Output Current	I_{OUT}	Nch $V_{DS}=0.5V$	$V_{DD}=1.20V$	0.23	0.50		mA
			$V_{DD}=2.40V$	1.60	3.70		mA
		Pch $V_{DS}=0.5V$	$V_{DD}=6.0V$	0.46	0.75		mA
Detect Voltage Temperature Characteristics	$\frac{\Delta V_{DET}}{\Delta T_{OPR} \times V_{DET}}$			± 100		ppm/ $^{\circ}C$	
Delay Time	t_{DLY}	$V_{DD}=7.0V, C_D=4.7nF$	12	17	22	ms	

Detection voltage (5.5V ~ 6.0V)

PARAMETER	SYMBOL	TEST CONDITONS	MIN	TYP	MAX	UNIT	
Detect Voltage	V_{DET}		$-V_{DET}$ $\times 0.98$	$-V_{DET}$	$-V_{DET}$ $\times 1.02$	V	
Hysteresis Range	V_{HYS}		$-V_{DET}$ $\times 0.03$	$-V_{DET}$ $\times 0.05$	$-V_{DET}$ $\times 0.08$	V	
Supply Current	I_{SS}	$V_{DD}=7.5V$		1.4	5.0	μA	
Operating Voltage	V_{DD}		12			V	
Output Current	I_{OUT}	Nch $V_{DS}=0.5V$	$V_{DD}=1.20V$	0.23	0.50		mA
			$V_{DD}=2.40V$	1.60	3.70		mA
		Pch $V_{DS}=0.5V$	$V_{DD}=4.8V$	2.08	3.42		mA
Detect Voltage Temperature Characteristics	$\frac{\Delta V_{DET}}{\Delta T_{OPR} \times V_{DET}}$			± 100		ppm/ $^{\circ}C$	
Delay Time	t_{DLY}	$V_{DD}=7.5V, C_D=4.7nF$	12	17	22	ms	

■ DETECTION VOLTAGE RANGE vs. HYSTERESIS WIDTH

DETECTION VOLTAGE RANGE (V)	HYSTERESIS WIDTH V_{HYS} TYP (V)	DETECTION VOLTAGE RANGE (V)	HYSTERESIS WIDTH V_{HYS} TYP (V)
1.5V±2.0%	0.075	3.6V±2.0%	0.180
1.6V±2.0%	0.080	3.7V±2.0%	0.185
1.7V±2.0%	0.085	3.8V±2.0%	0.190
1.8V±2.0%	0.090	3.9V±2.0%	0.195
1.9V±2.0%	0.095	4.0V±2.0%	0.200
2.0V±2.0%	0.100	4.1V±2.0%	0.205
2.1V±2.0%	0.105	4.2V±2.0%	0.210
2.2V±2.0%	0.110	4.3V±2.0%	0.215
2.3V±2.0%	0.115	4.4V±2.0%	0.220
2.4V±2.0%	0.120	4.5V±2.0%	0.225
2.5V±2.0%	0.125	4.6V±2.0%	0.230
2.6V±2.0%	0.130	4.7V±2.0%	0.235
2.7V±2.0%	0.135	4.8V±2.0%	0.240
2.8V±2.0%	0.140	4.9V±2.0%	0.245
2.9V±2.0%	0.145	5.0V±2.0%	0.250
3.0V±2.0%	0.150	5.1V±2.0%	0.255
3.1V±2.0%	0.155	5.2V±2.0%	0.260
3.2V±2.0%	0.160	5.3V±2.0%	0.265
3.3V±2.0%	0.165	6.0V±2.0%	0.300
3.4V±2.0%	0.170		
3.5V±2.0%	0.175		

■ OUTPUT CONFIGURATIONS

Implementation	CMOS
With different power supplies	No
With active low reset CPUs	Yes
With active high reset CPUs	No
With voltage divider variable resistors	No

Example with one power supply

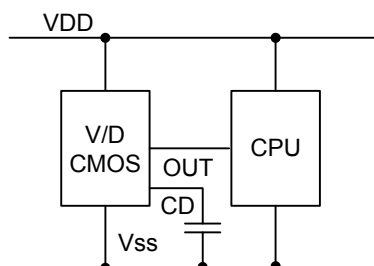

TYPICAL CHARACTERISTICS

88C25

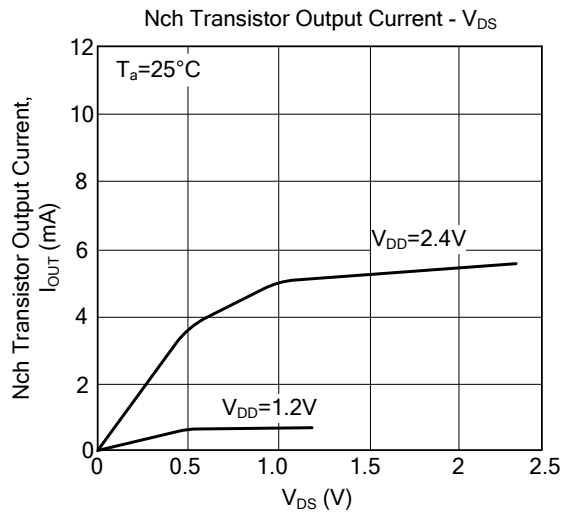
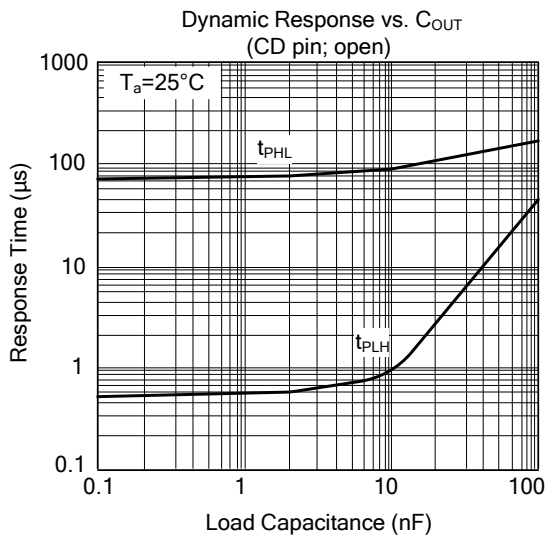
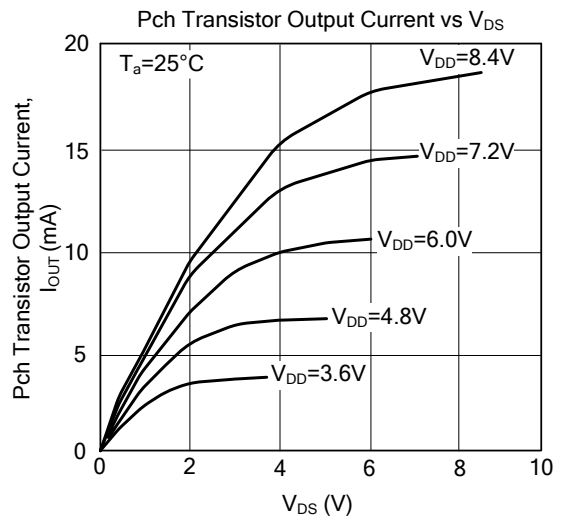
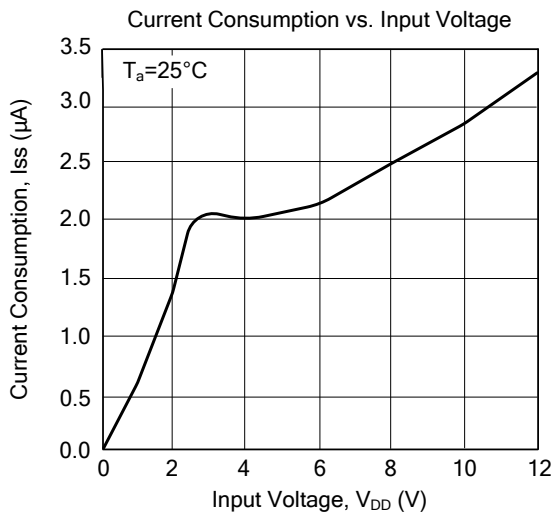
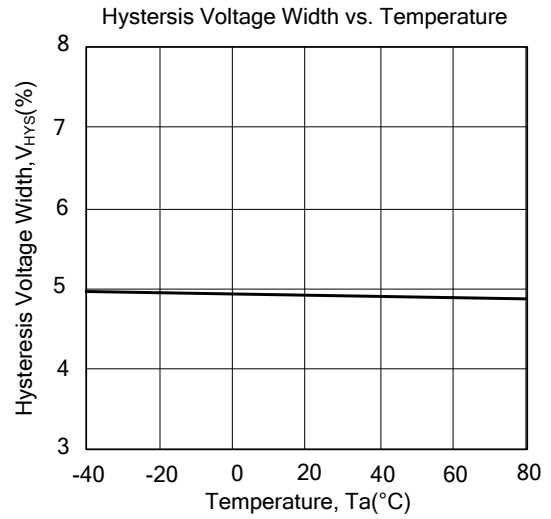
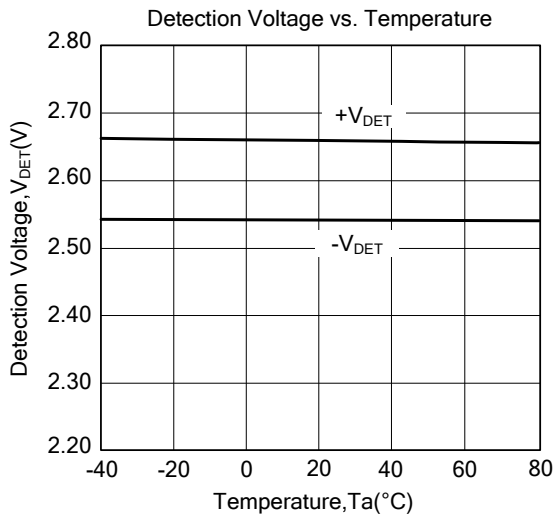

■ TYPICAL CHARACTERISTICS(Cont.)

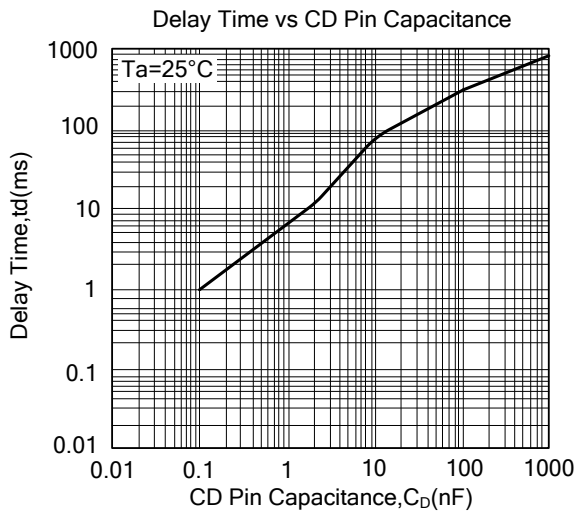
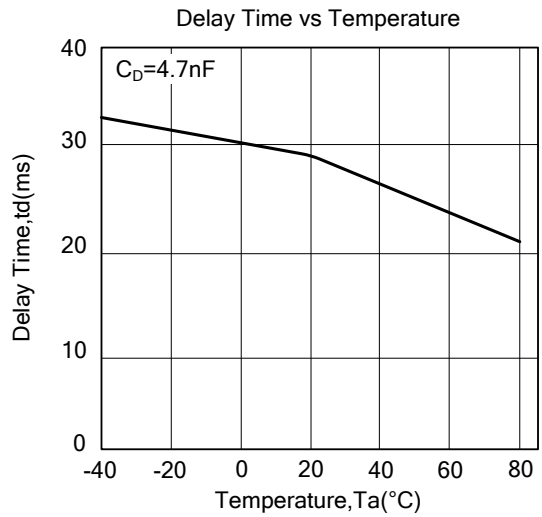
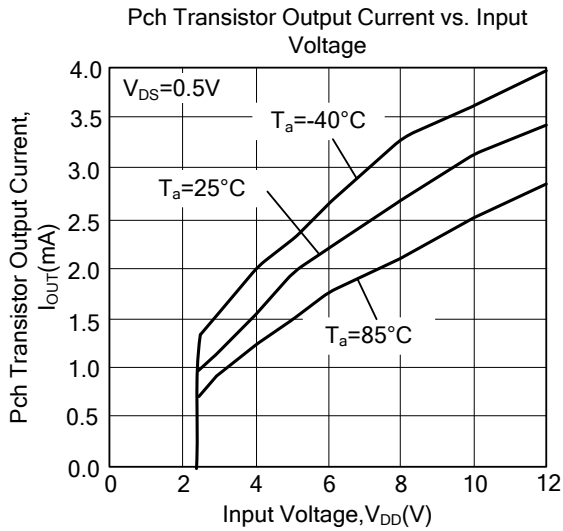
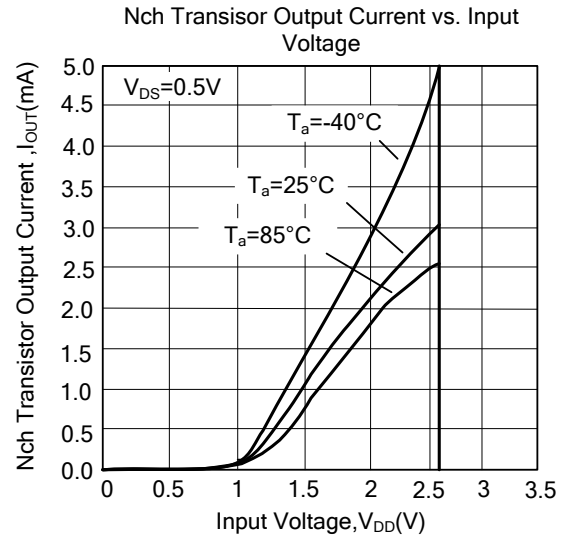
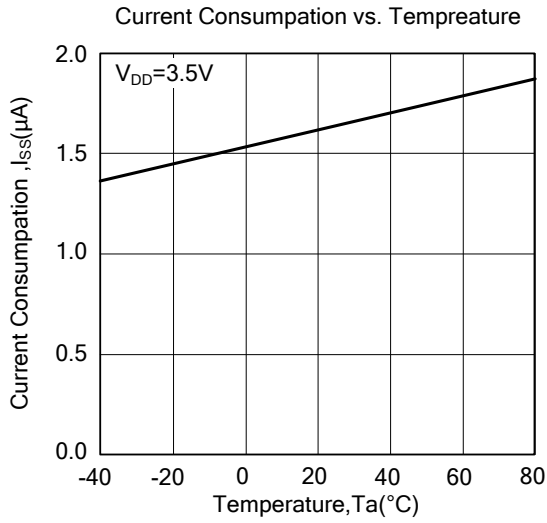

■ TYPICAL CHARACTERISTICS(Cont.)

88C28

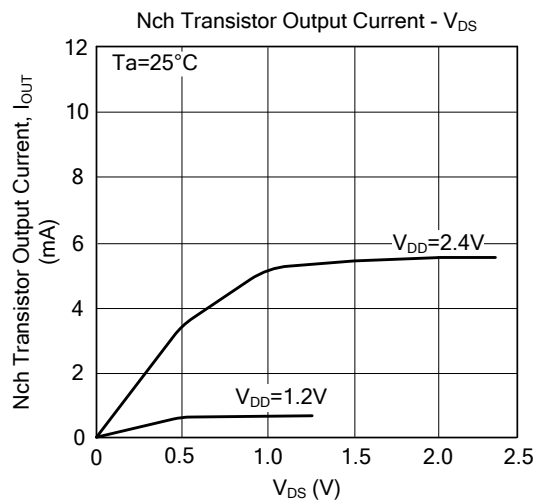
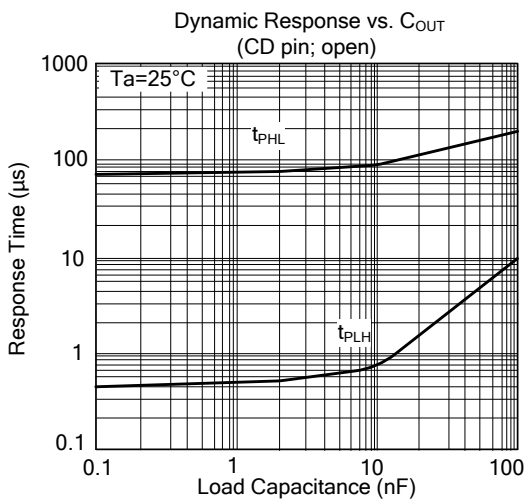
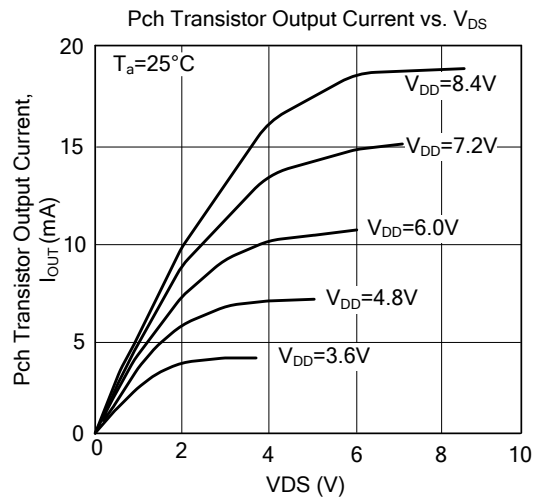
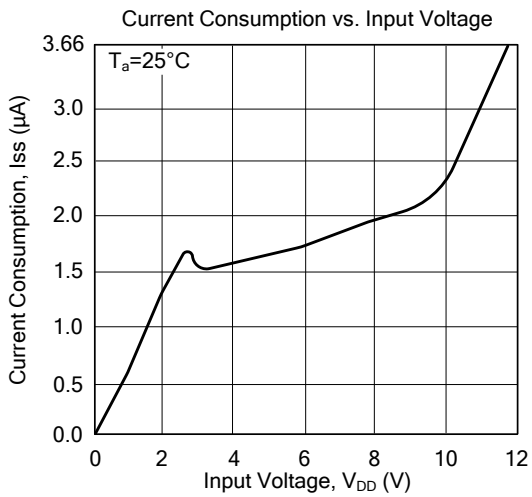
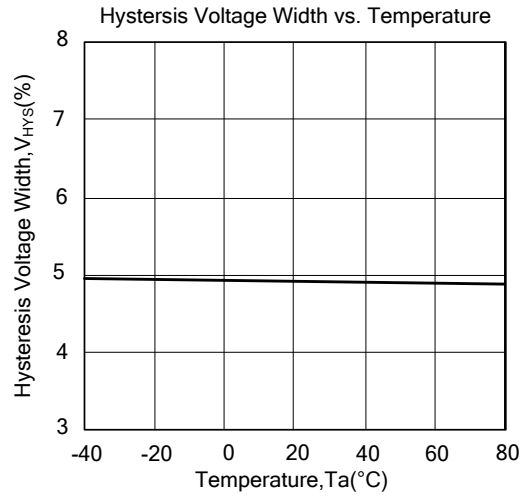
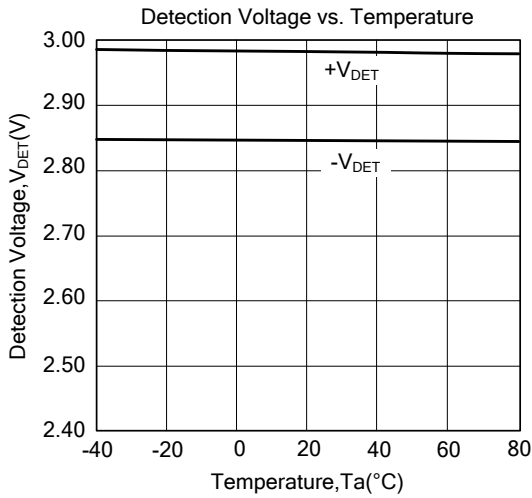

■ TYPICAL CHARACTERISTICS(Cont.)

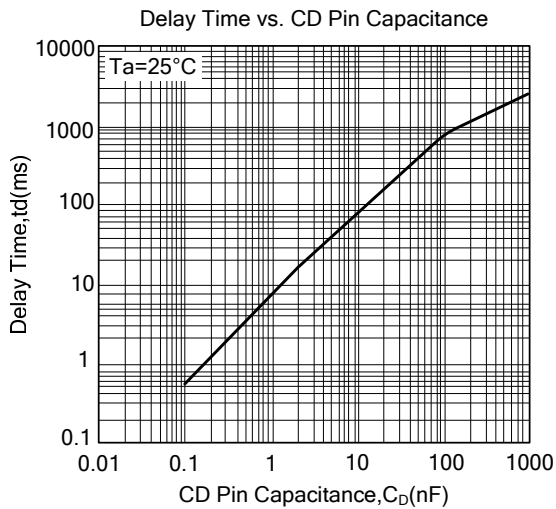
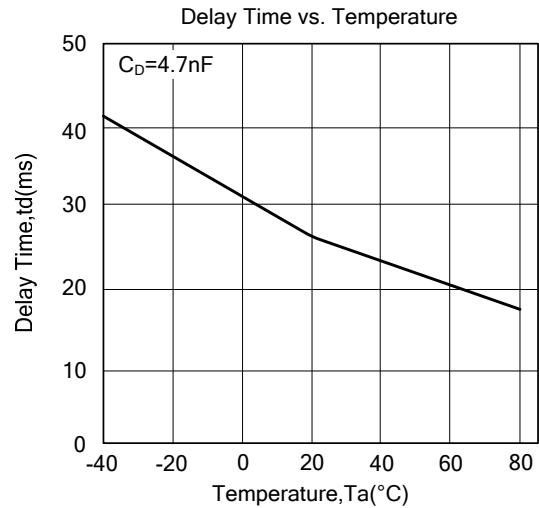
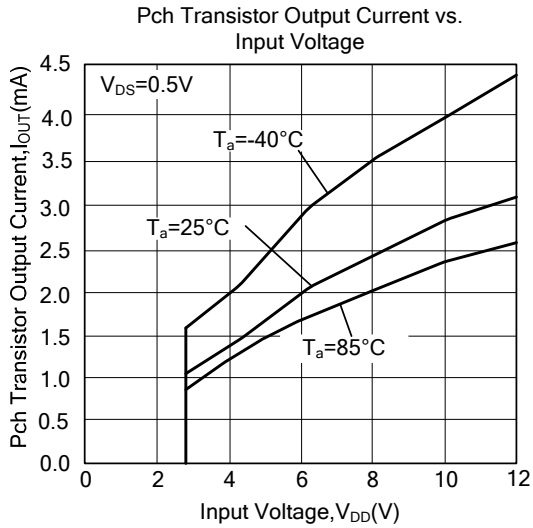
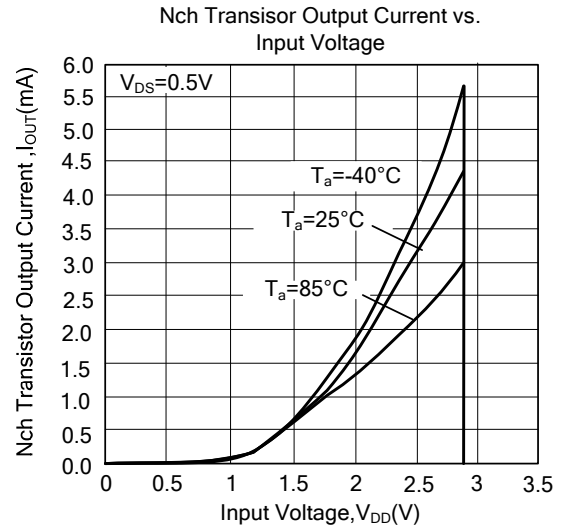
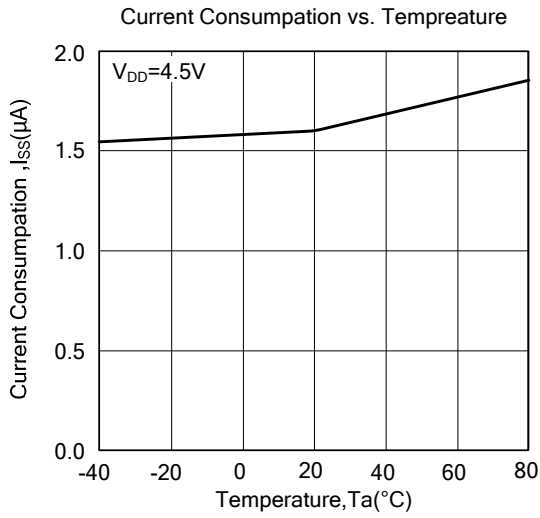

■ TYPICAL CHARACTERISTICS(Cont.)

88C33

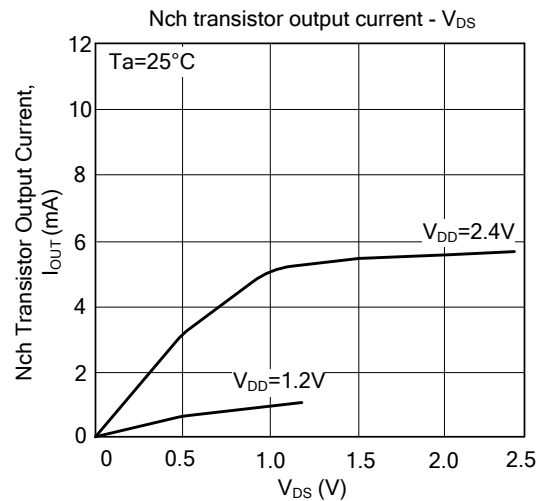
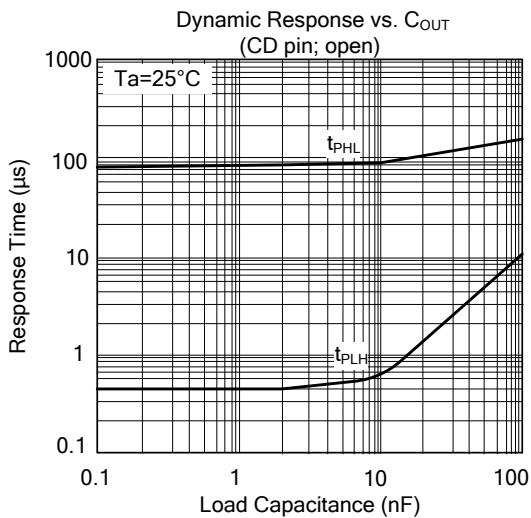
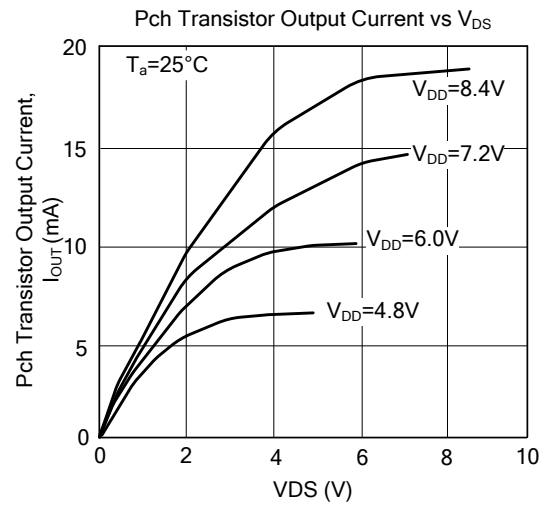
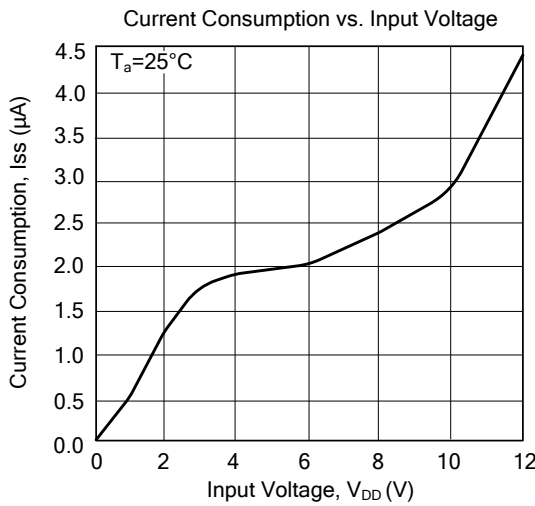
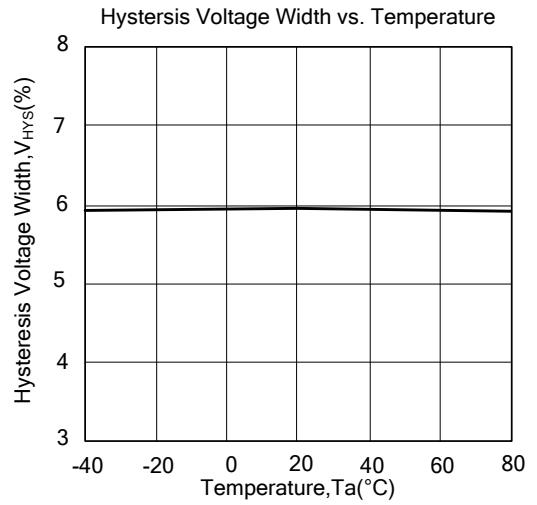
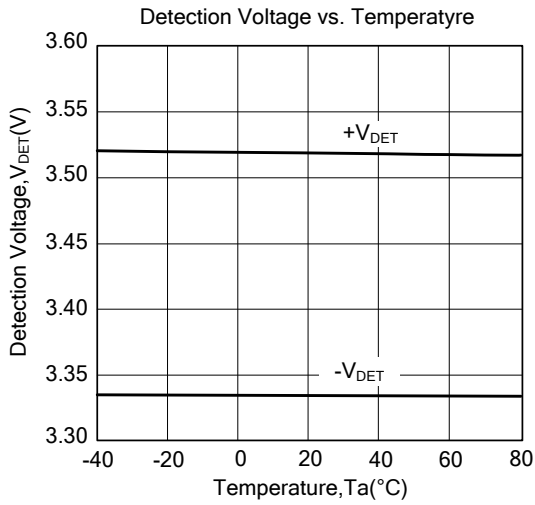

■ TYPICAL CHARACTERISTICS(Cont.)

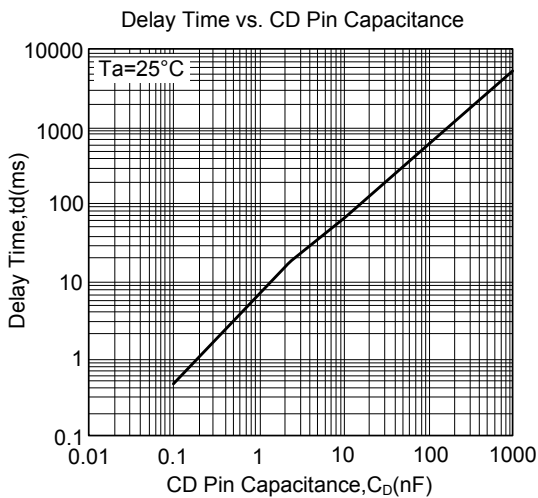
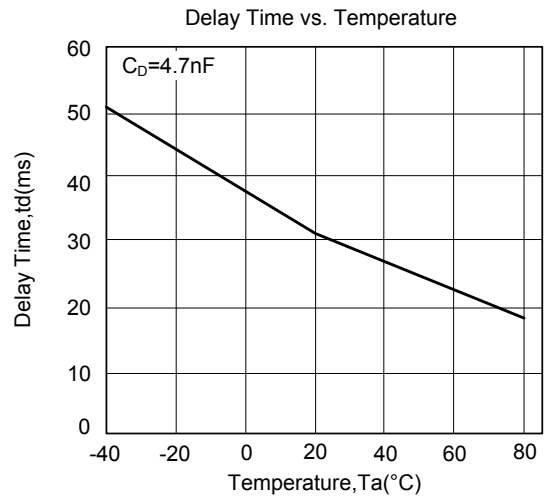
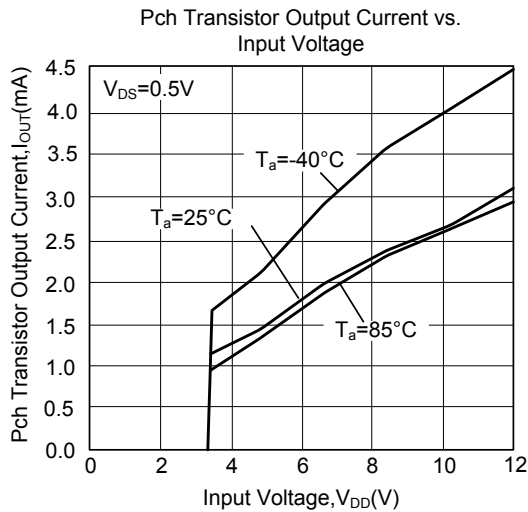
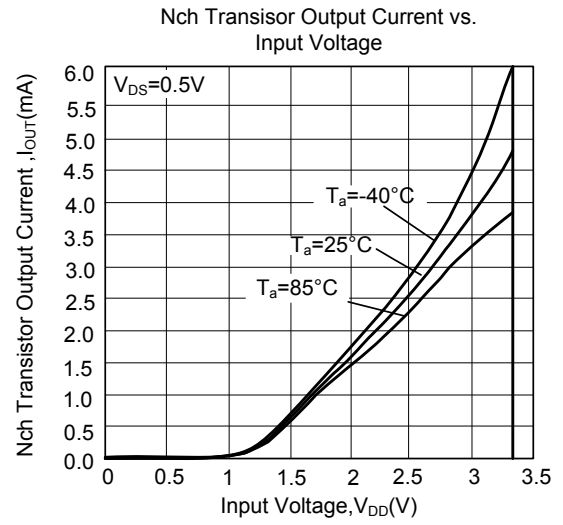
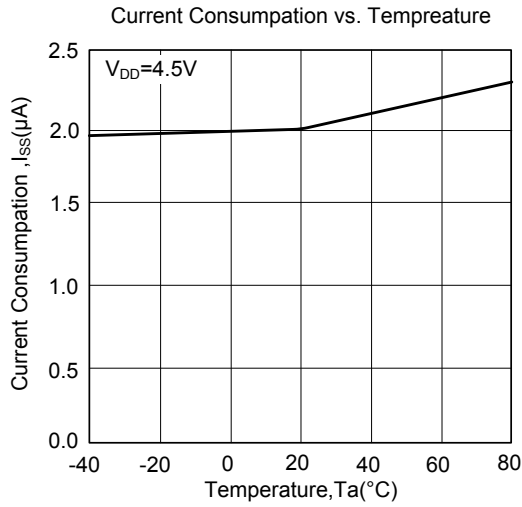

UTC assumes no responsibility for equipment failures that result from using products at values that exceed, even momentarily, rated values (such as maximum ratings, operating condition ranges, or other parameters) listed in products specifications of any and all UTC products described or contained herein. UTC products are not designed for use in life support appliances, devices or systems where malfunction of these products can be reasonably expected to result in personal injury. Reproduction in whole or in part is prohibited without the prior written consent of the copyright owner. The information presented in this document does not form part of any quotation or contract, is believed to be accurate and reliable and may be changed without notice.