

THESE DRAWINGS ARE THE PROPERTY OF QUALTEK ELECTRONICS AND NOT TO BE REPRODUCED FOR OR COMMUNICATED TO A THIRD PARTY WITHOUT THE EXPRESS WRITTEN PERMISSION OF AN OFFICER OF QUALTEK ELECTRONICS.

REVISION			
REV.	DESCRIPTION	DATE	APPROVED
B	RoHS Compliance	06-01-06	DP

1. PHYSICAL DIMENSIONS

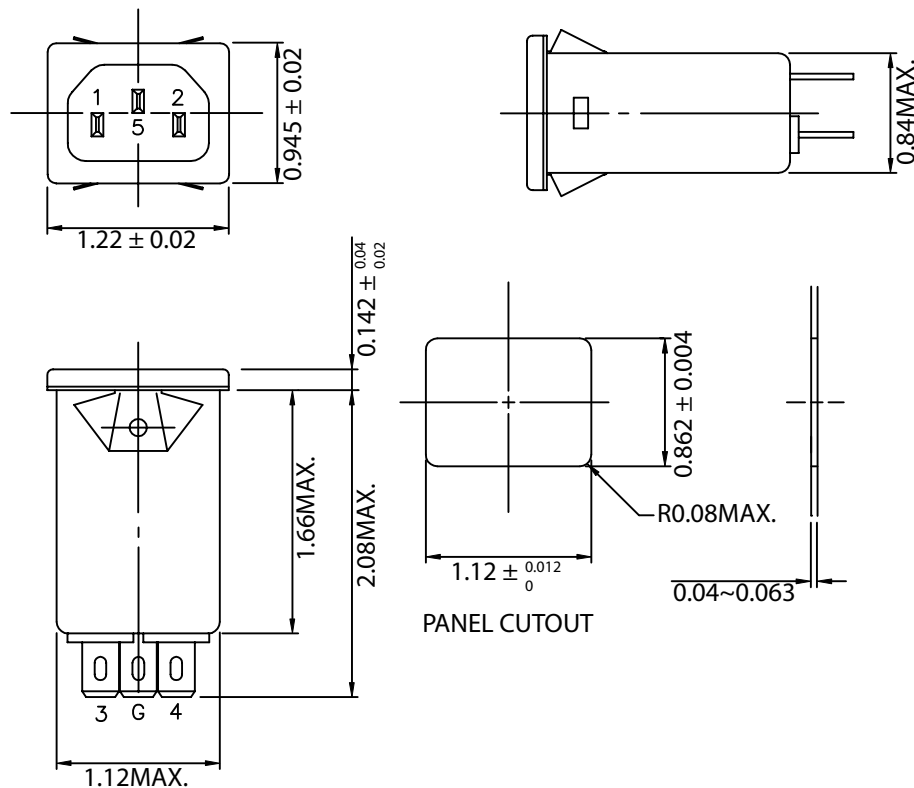

ELECTRICAL CHARACTERISTICS:

- 1-1. VOLTAGE RATING.....115/250VAC
- 1-2. CURRENT RATING
A. @ 115 VAC.....8 A RMS MAX
B. @ 250 VAC.....6 A RMS MAX
- 1-3. OPERATING FREQUENCY.....50/60Hz
- 1-4. LEAKAGE CURRENT: EACH LINE TO GROUND
A. @ 115 VAC 60Hz.....0.20 mA MAX
B. @ 250 VAC 50Hz.....0.40 mA MAX
- 1-5. HIPOT RATING (FOR ONE MINUTE)
A. LINE TO GROUND.....2250 VDC
B. LINE TO LINE.....1450 VDC
- 1-6. MINIMUM INSERTION LOSS IN dB: (AT 50 OHM SYSTEM)

FREQ. MHz	.01	.05	.10	.15	.50	1.0	5.0	10	30
COM. MODE dB	/	6	10	12	18	24	35	40	40
DIF. MODE dB	/	1	2	4	10	15	35	40	40

- 1-7. OPERATING TEMPERATURE.....-25° TO +85° C
- 1-8. SAFETY:
- 1-9. RoHS COMPLIANT

CONTROLLED

2. ELECTRICAL SCHEMATIC

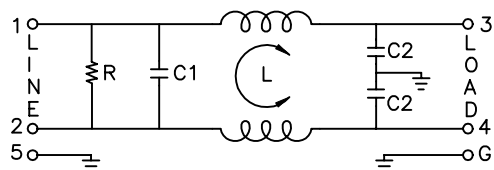

L: 0.8mH
C1: 0.1uF
C2: 2200pF
R: 1MΩ

Dim range (mm)	Tolerance +/- (mm)	Qualtek Electronics Corp. PPC DIVISION		
		Part Number: 869-06/007		
0-1	0.15	Description: EMI FILTER		
1-6	0.20			
6-18	0.30	UNIT: in	REV. B	
18-50	0.50			
50-120	0.70	Drawn / Date	Checked / Date	Approved / Date
120-250	0.90	B.ZHANG 09-17-01	09-17-01	JJH / 09-17-01
250-500	1.20			