



## DESCRIPTION

- $\Phi 18$  Circle single color LED light bar display series
- Standard brightness.
- Low current operation.
- Excellent character appearance.
- Easy mounting on P.C.boards or sockets

## Package Dimensions & Internal Circuit Diagram

### FYA-C18 Series

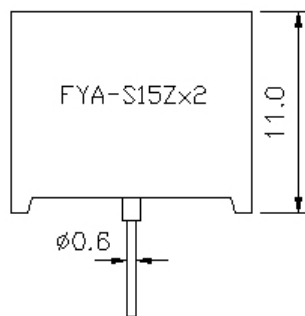
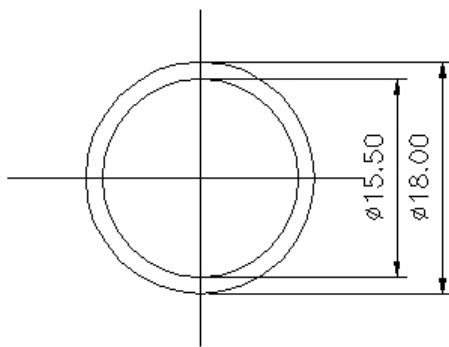

### FYA-C18ZX4

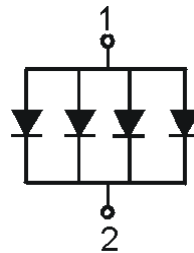

### FYA-C18ZX4-A



### FYA-C18ZX2



### FYA-C18Zxx

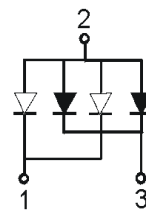

### FYA-C18ZX4-B



### Notes:

- All dimensions are in millimeters (inches)
- Tolerance is  $\pm 0.25(0.01)$  unless otherwise noted.
- Specifications are subject to change without notice.



**PartNO.:FYA-C18ZX -XX**

: Absolute maximum ratings (Ta=25°C)

Parameter	Symbol	Test Condition	Value		Unit
			Min	Max	
Reverse Voltage	VR	IR=30μA	5	-----	V
Forward Current	IF	-----	-----	30	mA
Power Dissipation	Pd	-----	-----	100	mW
Pulse Current	Ipeak	Duty=0.1mS, 1KHz	-----	150	mA
Operating Temperature	Topr	-----	-40	+85	° C
Storage Temperature	Tstr	-----	-40	+85	° C

• -XX: Surface / Lens color:

Number	0	1	2	3	4	5
<b>Ref Surface Color</b>	White	Black	Gray	Red	Green	
<b>Epoxy Color</b>	Water clear	White diffused	Red Diffused	Green Diffused	Yellow Diffused	



**PartNO.:FYA-C18ZX -XX**

■ **Description:**

• Color Code & Chip characteristics: **(Test Condition: IF=20mA)**

Emitting Color		Dice Material	Peak Wave Length( $\lambda_P$ )	Spectral Line halfwidth( $\Delta\lambda_{1/2}$ )	Forward Voltage(VF) Unit:V		Luminous Intensity (Iv) Unit:mcd
					Typ	Max	
H	Red	GaP	700nm	90nm	2.20	2.50	5.0
S, SR	Hi Red	AlGaAs,SH	660nm	20nm	1.80	2.20	15-20
D	Super Red	AlGaAs,DH	660nm	20nm	1.80	2.20	20-30
LR	Ultra Red	AlGaAs,DDH	660nm	20nm	1.90	2.40	26-38
HR	HE Red	GaAsP	640nm	45nm	1.90	2.40	50-80
E	Orange	GaAsP	630nm	35nm	2.10	2.50	10-20
A	Amber	GaAsP	610nm	35nm	2.10	2.50	15-20
Y	Yellow	GaAsP	590nm	35nm	2.10	2.50	15-20
G	Green	GaP	570nm	30nm	2.20	2.50	14-18
Ultra brightness							
UH R	Ultra Hi Red	AlGaInP	645nm	20nm	2.10	2.50	80-150
UE	Ultra Orange	AlGaInP	630nm	20nm	2.10	2.50	180-210
UA	Ultra Amber	AlGaInP	610nm	20nm	2.10	2.50	90-120
UY	Ultra Yellow	AlGaInP	590nm	20nm	2.10	2.50	150-200
UG	Ultra Green	AlGaInP	570nm	30nm	2.20	2.50	60-100
PG	Ultra Pure Green	InGaN	520nm	36nm	2.80	3.80	260-310
BG	Ultra Blue Green	InGaN	505nm	36nm	2.80	3.80	260-310
B	Blue	InGaN	430nm	30nm	2.80	3.80	10-20
UB	Ultra Blue	InGaN	470nm	30nm	2.80	3.80	80-90
			460nm	30nm	2.80	3.80	80-90
V	UV	InGaN	405nm		2.80	3.80	5-8
W	White	InGaN	X=0.29,y=0.30		2.80	3.80	180-200
U W	Ultra White	InGaN	X=0.29,y=0.30		2.80	3.80	180-200
Segment-to-Segment Luminous Intensity ratio(Iv-M)					1.5:1		



**PartNO.:FYA-C18ZX -XX**

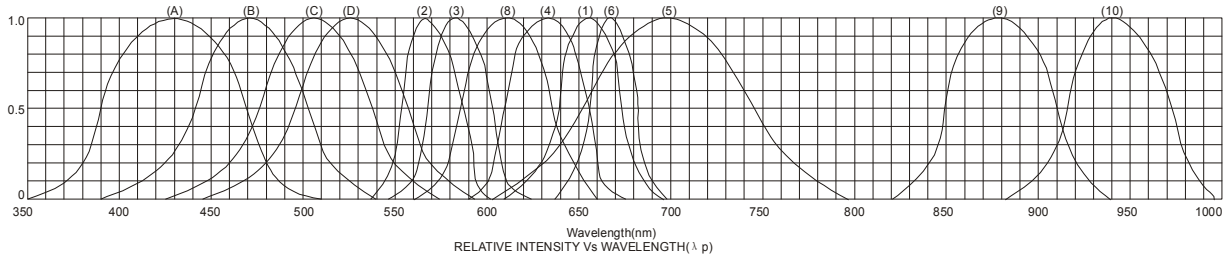

- |   |                                      |
|---|--------------------------------------|
| (1) - GaAsP/GaAs 655nm/Red                | (9) - GaAlAs 880nm                   |
| (2) - GaP 570nm/Yellow Green              | (10) - GaAs/GaAs & GaAlAs/GaAs 940nm |
| (3) - GaAsP/GaP 585nm/Yellow              | (A) - GaN/SiC 430nm/Blue             |
| (4) - GaAsP/GaP 635nm/Orange & Hi-Eff Red | (B) - InGaN/SiC 470nm/Blue           |
| (5) - GaP 700nm/Bright Red                | (C) - InGaN/SiC 505nm/Ultra Green    |
| (6) - GaAlAs/GaAs 660nm/Super Red         | (D) - InGaAl/SiC 525nm/Ultra Green   |
| (8) - GaAsP/GaP 610nm/Super Red           |                                      |

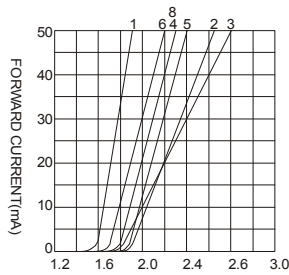

FORWARD VOLTAGE (Vf)  
FORWARD CURRENT VS.  
FORWARD VOLTAGE

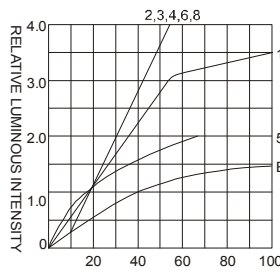

FORWARD CURRENT (mA)  
RELATIVE LUMINOUS  
INTENSITY VS. FORWARD  
CURRENT

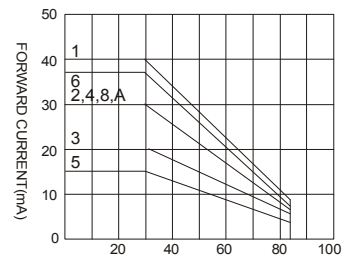

AMBIENT TEMPERATURE Ta(°C)  
FORWARD CURRENT VS. AMBIENT  
TEMPERATURE

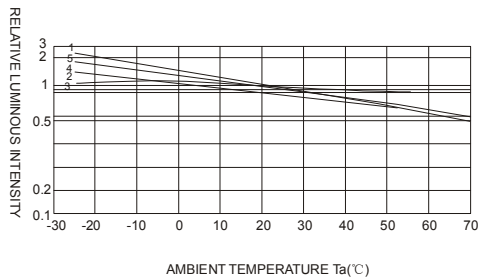

AMBIENT TEMPERATURE Ta(°C)

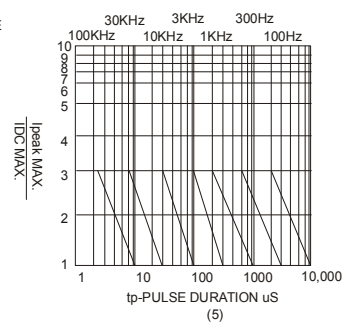
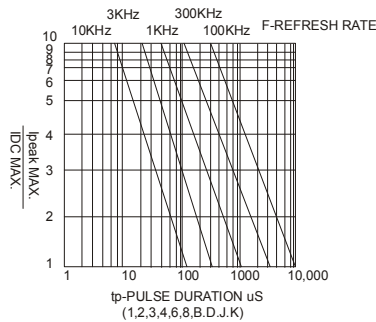

NOTE: 25°C free air temperature unless otherwise specified



**NINGBO FORYARD OPTO  
ELECTRONICS CO.,LTD.**

**LED BARGRAPH DISPLAY**

**PartNO.:FYA-C18ZX -XX**

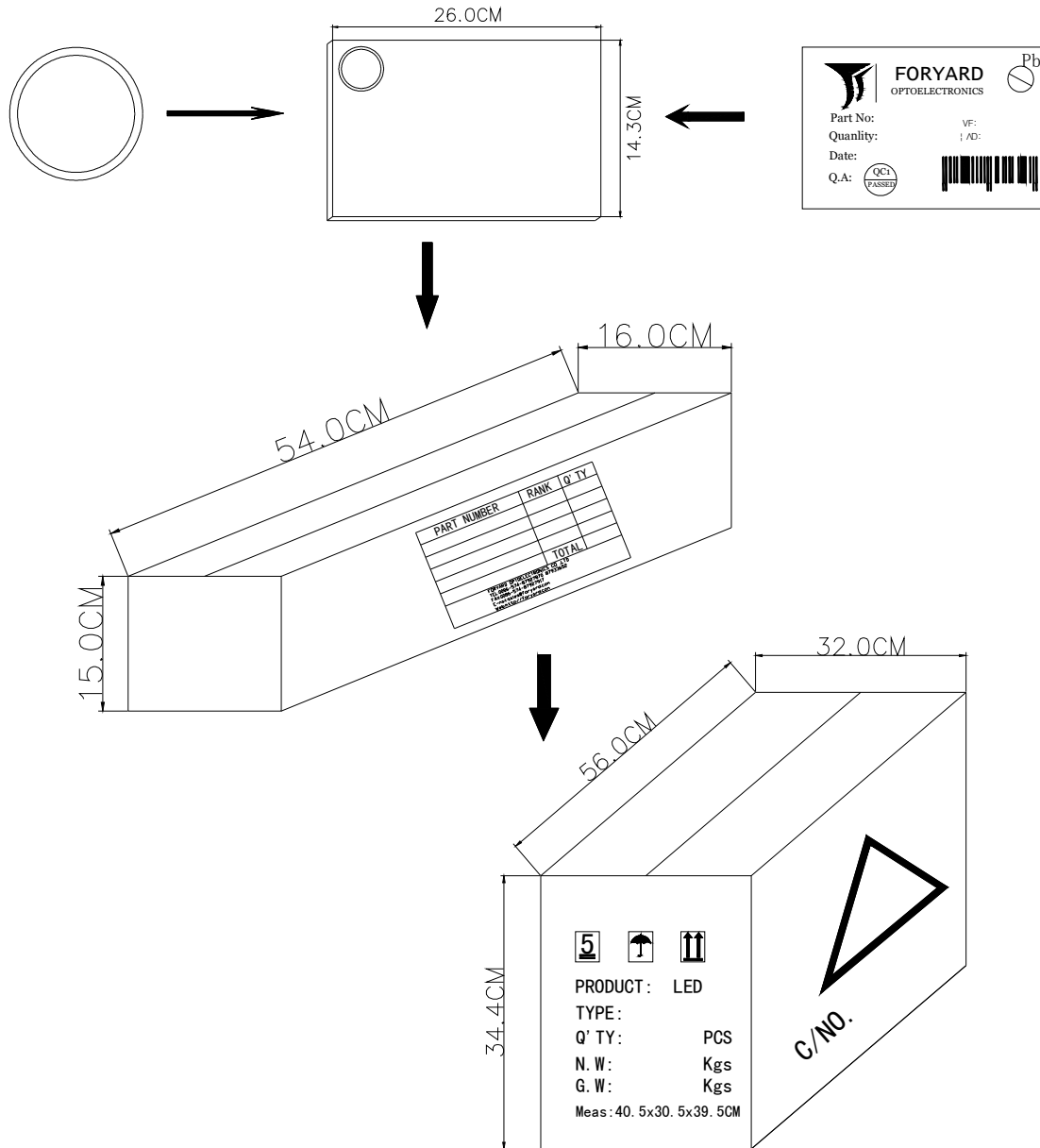

type	QTY/foam(pcs)	QTY /Bundle (pcs)	QTY /CARTONDimension

ADD: NO.115 QiXin Road NingBo Zhejiang China ZIP: 315051  
 TEL: 0086-574-87927870 87933652 FAX:0086-574-87927917  
[Http://www.foryard.com](http://www.foryard.com) E-mail:sales@foryard.com